

Electronic Balance Instruction Manual

UW series
UX series

For Basic Operation

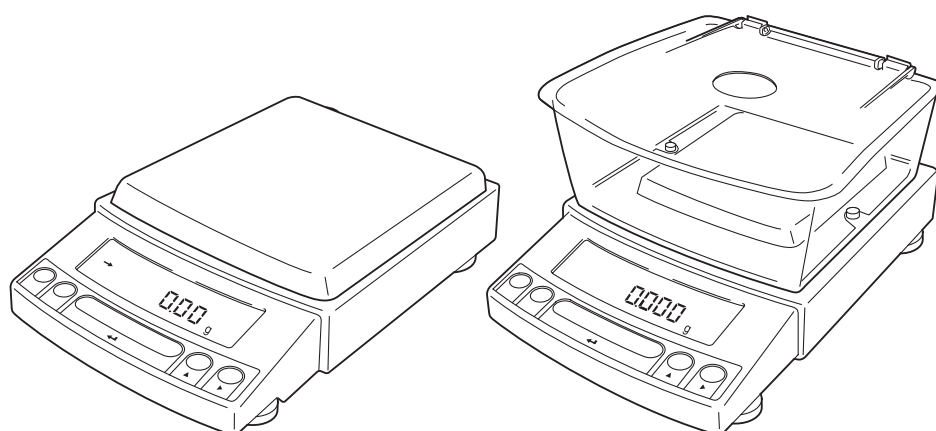

Read the instruction manual thoroughly before you use the product.
Keep this instruction manual for future reference.

 **SHIMADZU CORPORATION**
KYOTO JAPAN

ANALYTICAL & MEASURING INSTRUMENTS DIVISION

This page is intentionally left blank.

Requests

- Provide this manual to the next user in the event that the instrument is transferred.
- To ensure safe operation, contact your Shimadzu Balance representative for installation, adjustment, or reinstallation after moving the instrument to a different site.

Notices

- The content of this manual is subject, without notice, to modifications for the sake of improvement.
- Every effort has been made to ensure that the content of this manual was correct at the time of creation. However, in the event that any mistakes or omissions are discovered, it may not be possible to correct them immediately.
- The copyright of this manual is owned by Shimadzu Corporation. Reproduction and duplication of whole or part of the content without permission of the company are strictly prohibited.
- "Microsoft", "Windows", and "Excel" are registered trademarks of Microsoft Corporation of the U.S.A. in the United States and other countries. All other company names and product names that appear in this manual are trademarks or registered trademarks of the companies concerned. Note that ™ and ® indications are not used.
- The company names, organization names and product names in this manual are trademarks or registered trademarks of the companies and organizations concerned.
- Shimadzu does not guarantee that the WindowsDirect communication function will operate without problems on all PCs. Shimadzu will accept no responsibility for any trouble that arises as a result of using this function. You are recommended to back up all important data and programs in advance.

© 2002-2017 Shimadzu Corporation. All rights reserved.

Notation Conventions



Note

This instruction manual uses the following notation conventions to indicate Safety Precautions and additional information.



Caution

Indicates a potentially hazardous situation that may result in injury to personnel or equipment damage.



Note

Provides additional information needed to properly use the balance.

Other conventions used in this manual include:

Item	Description
1, 2, 3	Indicates the step number in a procedure or a sequence of changes in the balance display.
[] key	Indicates the operation key on the balance. See 2.2 .
mass display	Indicates that the balance is in the weighing mode and mass is displayed in one of the weighing units.
	These sections include information to make using the balance more convenient.
No.	Indicates the menu item to be selected. The number in the <input type="text"/> is the number of the menu item on the Menu Map. See 7.2 "Menu Map" .

Notes on the use of verified balances as legal measuring instruments

Important notes about the use of verified balances as legal measuring instruments in the EU are highlighted with the shadow.

Examples:

Using a verified balance as a legal measuring instrument in the EU:

Not applicable to a verified balance as a legal measuring instrument in using region:



There are special requirements on using a verified balance as a legal measuring instrument in the EU. With the verified balances, some of the functions are either unavailable or restricted.

"EU" includes the signatories of the European Economic Area agreement.



Safety Precautions To be strictly observed





To ensure that you use the balance safely and correctly, read the following precautions carefully and observe them.

The levels of danger and damage that will arise if the balance is used incorrectly are classified and indicated as shown below.

 WARNING	Indicates a potentially hazardous situation which, if not avoided, could result in serious injury or possibly death.	 CAUTION	Indicates a potentially hazardous situation which, if not avoided, may result in minor to moderate injury or equipment damage.
--	--	--	--

Precautions are classified and explained by using one of the symbols below, depending on the nature of the precaution.

 Instructions	Indicates an action that must be performed.	 Prohibitions	Indicates an action that must NOT be performed.
---	---	---	---

 WARNING	
 Prohibitions	<p>Never disassemble, modify or attempt to repair this product or any accessory.</p> <p>You could sustain an electric shock or the product could operate abnormally. If you believe that the balance has failed, contact your Shimadzu representative.</p>
 Instructions	<p>Use the balance with correct power supply and voltage.</p> <p>Use the balance with the attached AC adapter.</p> <p>Using the balance with an incorrect power supply or voltage will lead to fire or trouble with the balance. Note also that if the power supply or voltage is unstable or if the power supply capacity is insufficient, it will not be possible to obtain satisfactory performance from the balance.</p>
 Instructions	<p>Use the correct weighing units.</p> <p>Using incorrect weighing units can lead to accidents as a result of weighing errors. Check that the weighing units are correct before starting weighing.</p>
 Prohibitions	<p>Do not use the balance outdoors or anywhere where it will be exposed to water.</p> <p>You could sustain an electric shock or the product could operate abnormally.</p>

⚠ CAUTION



Prohibitions

Avoid locations where the balance will be exposed to any of the following.

This could cause accidents or poor performance.

- Air flow from an air conditioner, ventilator, door or window
- Extreme temperature changes
- Vibration
- Direct sunlight
- Corrosive or flammable gases
- Dust, electromagnetic waves or a magnetic field

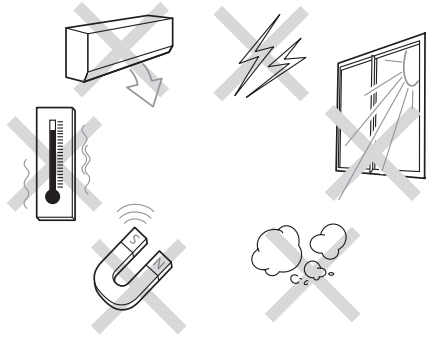

Instructions

Install the balance on a strong and stable flat table or floor in the room.

Placing the balance in an unstable site could lead to injury or trouble with the balance. When selecting the installation site, take into account the combined weight of the balance and the item to be weighed.



Instructions

After a power outage, turn the power back ON.

When a power outage occurs, the power is shut off automatically. Therefore, begin operation from [4.4 "Turning ON the Power"](#) (^ page 18) again.



Instructions

Treat the balance with care and respect.

The balance is a precision instrument. Subjecting it to impacts could cause it to fail. When moving the balance, remove pan and pan supporter. Grasp it firmly with both hands to carry it.

If the balance has to be stored for a long time, store it in the packaging box in which it was delivered.



Prohibitions

Do not connect anything other than peripheral devices specified by Shimadzu to the balance's connector.

If you do, the balance may stop working normally. In order to avoid trouble, always connect peripheral devices in accordance with the directions in this manual.



Instructions

If you detect anything abnormal (e.g. a burning smell) disconnect the AC adapter immediately.

Continuing to use the balance with an abnormality could lead to fire or an electric shock.

Shimadzu Balances and 21 CFR Part 11

21 CFR Part 11

21 CFR Part 11, Electronic Records, Electronic Signatures, Final Rule (often referred to as Part 11) is the United States Food and Drug Administration (FDA) regulation affecting computer resources and electronic records that are used for any document that is required to be kept and maintained by FDA regulations.

Requirements concerning computer resources security are key elements in Part 11.

The controls implemented as a result of security related requirements are intended to result in trusted records.

Shimadzu CLASS-Balance Agent

Shimadzu provides a means for compliance with 21 CFR Part 11 with Shimadzu CLASS-Balance Agent software, part of a comprehensive laboratory data management system, Shimadzu CLASS Agent.

Ask your Shimadzu representative about it.

Shimadzu WindowsDirect

When Shimadzu balances are integrated with laboratory software by means of our WindowsDirect function, no communication software is required or used.

The Shimadzu balance functions as a primary device in the system, just as a keyboard, mouse or other data entry hardware does.

For this reason, system validation and compliance may be greatly simplified with the use of Shimadzu balances.

Two-way Communication

Shimadzu balances have always been computer friendly and they can be set up for bi-directional communication as part of a fully automated production system or LIMS.

This manual includes the command codes and information needed by programmers to integrate Shimadzu balances with their software.

Action for Environment (WEEE)

To all user of Shimadzu equipment in the European Union:

Equipment marked with this symbol indicates that it was sold on or after 13th August 2005, which means it should not be disposed of with general household waste. Note that our equipment is for industrial/professional use only.

Contact Shimadzu service representative when the equipment has reached the end of its life.

They will advise you regarding the equipment take-back.

With your co-operation we are aiming to reduce contamination from waste electronic and electrical equipment and preserve natural resource through re-use and recycling.

Do not hesitate to ask Shimadzu service representative, if you require further information.

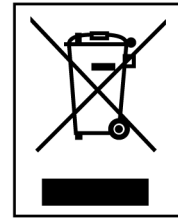

WEEE Mark

Contents

1. Introduction	1
2. Name and Function of Components	2
2.1 Components	2
2.2 Key Panel and Operation	4
2.3 Balance Display and Function	5
3. Specifications	6
4. Installation	8
4.1 Choosing the Installation Site	8
4.2 Unpacking and Delivery Inspection	10
4.3 Installation	13
4.4 Turning ON the Power	18
4.5 Span Calibration	19
5. Basic Operation	22
5.1 Weighing	22
5.2 Changing the Unit Display	23
6. WindowsDirect Function	24
6.1 Introduction: Experience it!	24
6.2 Set Up WindowsDirect	24
6.2.1 Setting Up the Balance	24
6.2.2 Cable Connection	25
6.2.3 Setting Up the Computer	25
6.2.4 Start and Checking Operation	27
6.3 Troubleshooting the WindowsDirect Communication Function 28	
7. Menu Item Selection	30
7.1 What is the Menu?	30
7.2 Menu Map	30
7.3 Menu Item Selection Procedure	31
7.4 Setting Numeric Values	33
7.5 Related Useful Functions	34
7.5.1 Last Menu Recall	34
7.5.2 Returning to the Default Settings (menu reset)	34
7.5.3 Menu Lock	35

8. Built-in Clock Set-up	36
8.1 Date	36
8.2 Date Output Style	36
8.3 Time	37
8.4 Setting Display During Stand-by	37
9. Display Selection	38
9.1 Bar graph display	38
9.2 Changing the Minimum Display Digit (10d:1d)	38
10. Calibration	39
10.1 What is calibration?	39
10.2 Calibration Execution	40
10.2.1 Span Calibration Using the Built-in Weight (UW Series Only)	40
10.2.2 Calibration Check Using the Built-in Weight (UW Series Only)	41
10.2.3 Span Calibration Using External Weights	42
10.2.4 Calibration Check Using External Weights	43
10.3 Calibration Setting	44
10.3.1 Selecting the Calibration Type	44
10.3.2 PSC Fully-automatic Calibration (UW series only)	44
10.3.3 Clock-CAL Fully-automatic Calibration (UW series only)	45
10.3.4 PCAL: Calibration of the Built-in Weight (UW series only)	46
10.3.5 PCAL Password Setting (UW series only)	47
10.4 For GLP/GMP/ISO Conformance	48
10.4.1 Calibration Report Setting	48
10.4.2 Balance ID Setting	48
11. Environment	49
11.1 Overview	49
11.2 Stability and Response (Averaging)	49
11.3 Stability Detection and Settings	50
11.3.1 Stability Detection Band	51
11.3.2 Timing of Stability Mark Illumination and Data Output	52
11.4 Tracking	52
12. Units	53
12.1 Unit Display Set-up	53
12.2 Percentage (%) Conversion	54
13. Enhancing Productivity	55
13.1 Checkweighing and Target Display	55

13.1.1 Checkweighing (Comparator) Display Type 1	56
13.1.2 Checkweighing (Comparator) Display Type 2	56
13.1.3 Target Mode	57
13.2 Piece Counting (PCS)	58
13.3 Auto Print	59
13.4 Auto Zero	61
13.5 Zero Range	62
13.6 Taring/Printing at Stability	63
13.7 Pretaring Value	64
14. Application Functions	65
14.1 Solid Specific Gravity Measurement	65
14.2 Liquid Density Measurement	68
14.3 Peak Hold	71
14.4 Interval Timer	73
14.5 Add-on Mode	74
14.6 Animal Weighing	76
14.7 Formulation Mode	79
15. Connecting Peripheral Instruments	81
15.1 Electronic Printer	81
15.2 Personal Computer - RS-232C -	82
15.2.1 Connecting the Cable	82
15.2.2 Data Format	83
15.2.3 Using Command Codes	85
15.2.4 Multi-Connection Mode	90
15.3 Communication Setting	93
15.3.1 Overview	93
15.3.2 Handshaking	93
15.3.3 Format	94
15.3.4 Communication Speed	94
15.3.5 Parity / Bit Length	94
15.3.6 Stop Bit	94
15.3.7 Delimiter	95
15.4 Decimal Point Symbol in Output Data	95
16. Maintenance and Transportation	96
16.1 Maintenance	96
16.2 Moving the Balance	96
17. Troubleshooting	97
17.1 General Display	97

17.2 Error Display	98
17.3 Troubleshooting	99
17.4 LCD (Liquid Crystal Display) Check	99

Appendices 100

A-1. Menu Map	100
A-2. Standard Accessories and Maintenance Parts List 105	
A-3. Optional Accessories List	106
A-4. Specifications of Connectors	107
A-5. Table of Unit Conversion Constants	108
A-6. Performance Checks	109
A-7. Below-Weigh Hook Dimensions	110
A-8. Index	111

1. Introduction

Shimadzu UW/UX series of toploading balances are a product of our 80 year history of developing and manufacturing weighing instruments.

Shimadzu UW/UX series of toploading balances utilize the patented Shimadzu UniBloc sensor, introduced in 1989, to achieve high performance, fast response, and durability. Available features include multiple units of measure, piece counting, checkweighing functions, auto print, and GLP/GMP/ISO output including date and time data from a built-in clock.

The new series also features Shimadzu's WindowsDirect communication, requiring no software installation to quickly integrate balances with lab or business software. This function eliminates data input errors and offers extensive flexibility for application development without compromising compliance or data security.

The UW series balance incorporates a motor-driven built-in calibration weight that can automatically calibrate sensitivity without the use of external weights.

Read this manual carefully before using this instrument and keep it with the balance for future reference.

This manual refers to the different types of UW and UX series (UW/UX series) balances as follows:

H type: UW/UX H

S type: UW/UX S

Where: represents the figure indicating the capacity, H indicates high resolution and S indicates standard resolution.

Suffix "V" is added for models with EC Type Approval.

The type of balance is classified as "large pan" or "small pan" depending on the capacity. The small pan models with minimum display of 0.001g come with a standard windbreak. Accordingly, the models are classified into the following three groups in "[4. Installation](#)".

- a. Large pan models: Capacity 2200g or higher
- b. Small pan models: Capacity 820g or lower (minimum display 0.01g)
- c. Small pan models: Capacity 1020g or lower (minimum display 0.001g, windbreak standard)

For information on the following points, please contact your Shimadzu Balance representative.

- Product warranty
- After service

2. Name and Function of Components

2.1 Components

a. Large pan model

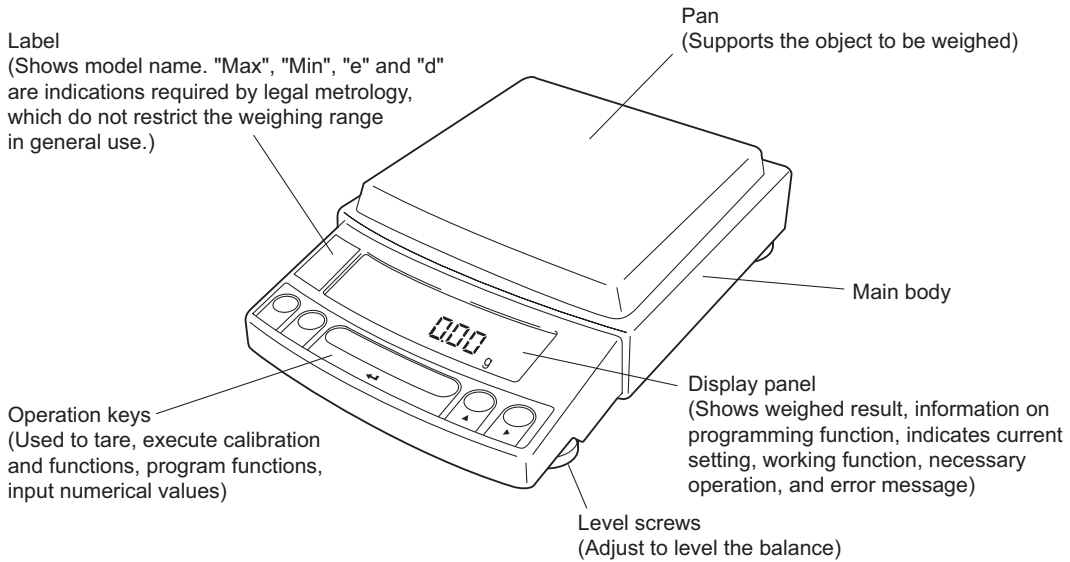

b. Small pan model (minimum display 0.01g)

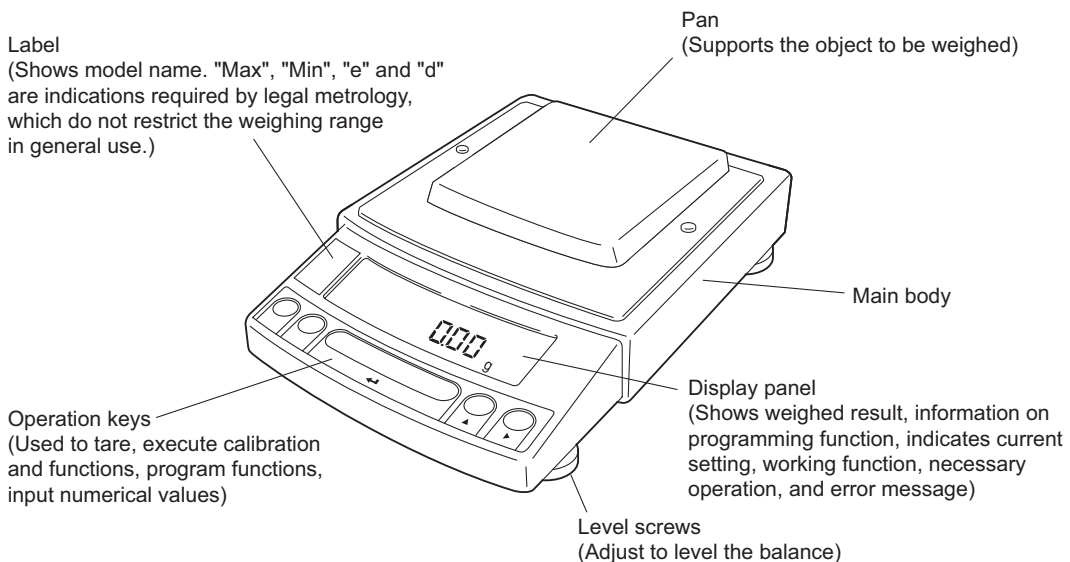

c. Small pan model (minimum display 0.001g, windbreak standard)

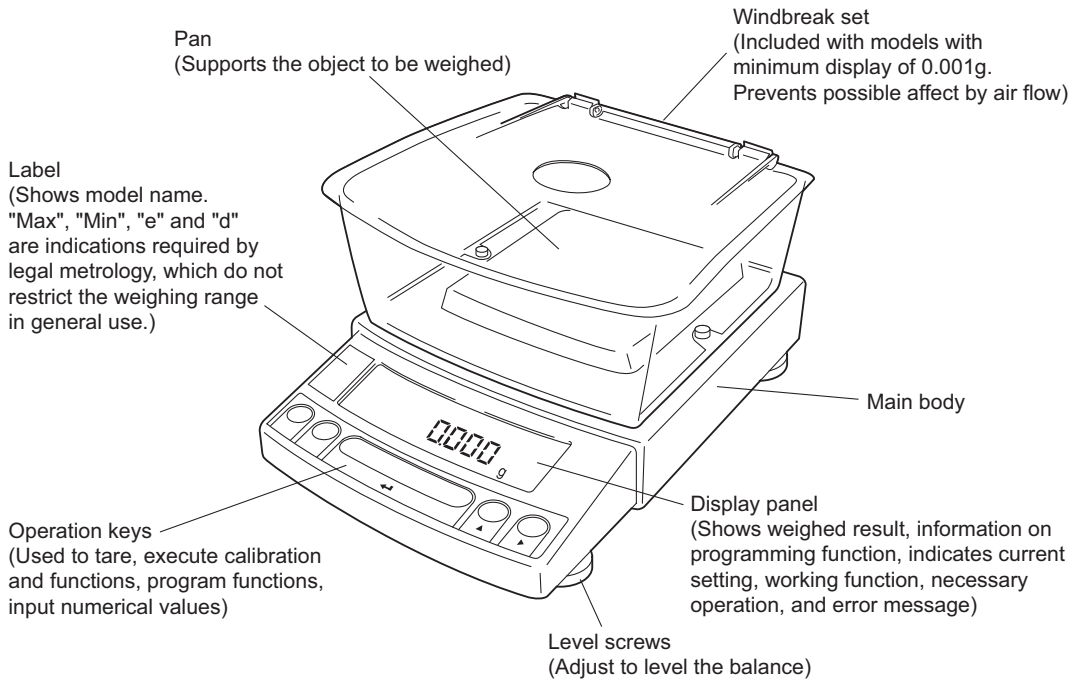

a, b, c. common

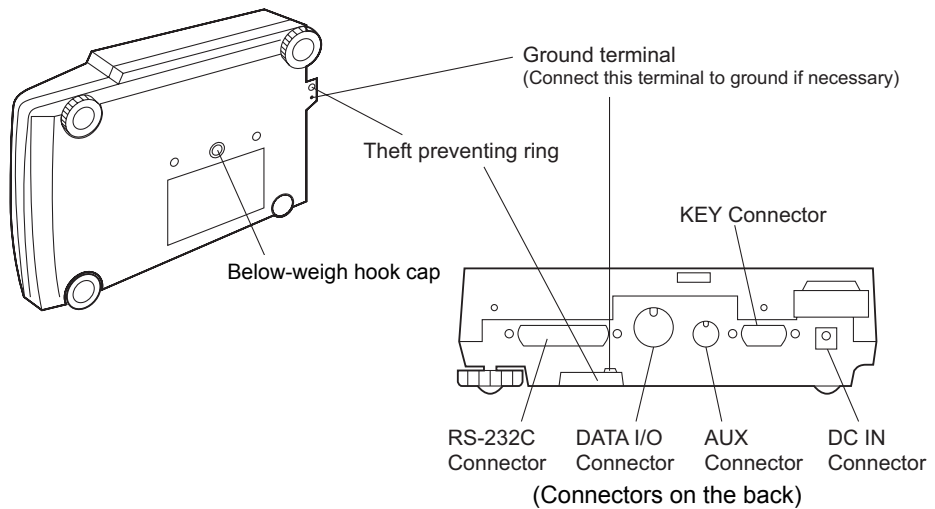

2.2 Key Panel and Operation

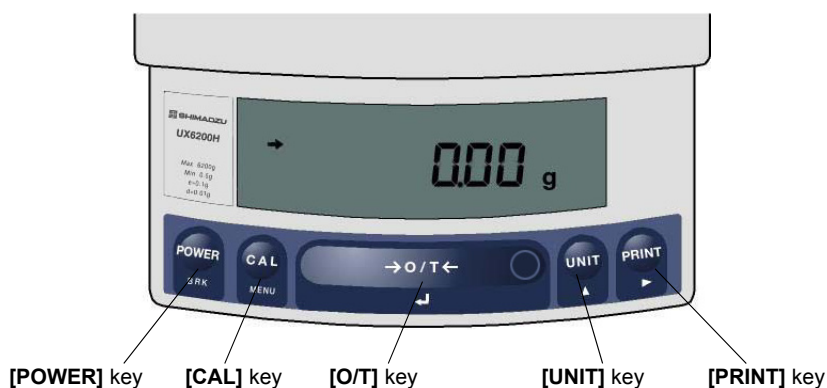

Functions of the keys

Key	During Weighing	
	Press Once and Release	Press and Hold for About 3 Seconds
[POWER]	Switches between the operation and standby modes.	Exits the application function and returns to the mass display.
[CAL]	Enters span calibration or menu item selection. (*1)	Displays the last menu item that was set. (Last menu recall)
[O/T]	Tares the balance. (Displays zero.) (*2) (*5) (*6)	Displays the Pretare value. (*7)
[UNIT]	Changes the weighing unit or selects the specific gravity measurement. (*3)	Switches between the 1d and 10d displays. (*4) (*7)
[PRINT]	Sends the displayed value to a peripheral device.	Sends the date and time to a peripheral device.

*1 This key is used to set values when percent (%), number (PCS), solid specific gravity (▼d), or liquid specific gravity (d) are displayed.

*2 When a Pretare value is set, zero is not displayed and [-Pretare value] is displayed. (*7)

*3 Units other than "g" must be set up before they can be used for measurement. Only gram (g), percent (%), and piece counting (PCS) are set-up before shipment. To set up other units or specific gravity measurement, refer to section 12., or 14.1, 14.2.

*4 When the unit is set to 10d, the resolution of the minimum display is decreased by one decimal place.

*5 In Pouring mode (See 11.2), the right-most part of [O/T] key marked with a circle functions as the switch for environmental condition setting. Otherwise this part functions the same way as the other parts of [O/T] key.

*6 Either "Taring" (at a weight exceeding 2.0% of the capacity) or "Zeroing" (at a weight within 2.0% of the capacity) takes place with a verified balance as a legal measuring instrument in using region.

*7 Not applicable to a verified balance as a legal measuring instrument in using region.

Key	During Menu Item Selection	
	Press Once and Release	Press and Hold for About 3 Seconds
[POWER]	Returns to the previous menu level	Returns to the mass display.
[CAL]	Moves to the next menu item.	Displays the last menu item that was set. (Last Menu Recall)
[O/T]	Selects or sets the currently displayed menu item, or enter into the displayed menu.	No operation.
[UNIT]	Increases the numeric value of the blinking digit by 1.	No operation.
[PRINT]	Moves to the next digit during numeric value entry.	No operation.

2.3 Balance Display and Function

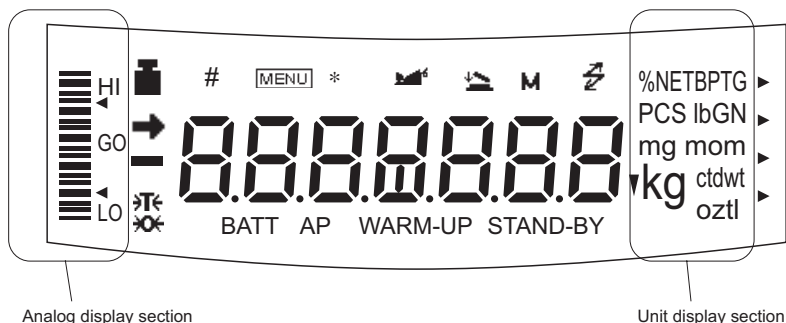

Display	Name	Description
→	Stability mark	Indicates that the weighed value is stable. (*1) In menu item selection, this symbol indicates currently selected item.
↵	Tare symbol	Indicates that a Pretare value has been set.(*2)
■	Weight symbol	Illuminates during span calibration. In menu selection, indicates setting related to calibration. Blinks before automatic span calibration starts. Note: Using a verified balance as a legal measuring instrument in using region: When PSC fully-automatic span calibration is not activated, operator must carry out span calibration with the built-in weight upon blinking of this symbol.
[]	Bracket	Note: Using a verified balance as a legal measuring instrument in using region: The figure bordered by the bracket is the auxiliary indicating device.
#	Number symbol	Indicates numeric value entry.
MENU	Menu symbol	Indicates that the menu lock is on. Illuminates during menu item selection.
*	Asterisk	Indicates that the displayed numeric value is not a mass value.
⚡	Communication symbol	Illuminates during communication to external equipment through the RS-232C or DATA I/O connector. In menu selection, indicates setting related to communication.
BATT	Battery symbol	When the balance is operated with the optional battery pack, this symbol illuminates to indicate that the battery voltage has dropped.
▼	Inverse triangle symbol	Indicates the set-up of solid specific gravity measurement. Used as a substitution of the decimal point.
⊗	Zero symbol	Indicates the set-up of Auto Zero function.(*2) Note: Using a verified balance as a legal measuring instrument in using region: Indicates that the balance is set exactly to "Zero" with the zero-setting function(+/-0.20e: e = verification scale interval).
🐾	Animal symbol	Indicates the set-up of Animal Weighing function.(*2)
➕	Add-on symbol	Indicates the set-up of Add-on mode or Formulation mode.
M	Memory symbol	Indicates the set-up of Formulation mode.
AP	Auto Print symbol	Indicates the set-up of Auto Print function.
STAND-BY	Stand-by symbol	Illuminates when the balance power is in the standby mode. Also illuminates when the application function has entered the standby mode.

*1 Stability mark

The displayed value may change while the stability symbol remains illuminated if the load is changing slowly or if the stability detection band has been set to a large value.

*2 Not applicable to a verified balance as a legal measuring instrument in using region

3. Specifications

UW Series Model	UW220H	UW420H	UW620H	UW820H	UW1020H	UW2200H	UW4200H	UW6200H	UW420S	UW820S	UW4200S	UW8200S
Capacity	220g	420g	620g	820g	1020g	2200g	4200g	6200g	420g	820g	4200g	8200g
Minimum display	0.001g	0.001g	0.001g	0.001g	0.001g	0.01g	0.01g	0.01g	0.01g	0.01g	0.1g	0.1g
Calibration range with external weights	100 - 220g	100 - 420g	100 - 620g	400 - 820g	500 - 1020g	1000 - 2200g	1000 - 4200g	1000 - 6200g	100 - 420g	100 - 820g	1000 - 4200g	1000 - 8200g
Repeatability (σ)	$\leq 0.001g$					$\leq 0.01g$			$\leq 0.008g$		$\leq 0.08g$	
Linearity	$\pm 0.002g$			$\pm 0.003g$		$\pm 0.02g$			$\pm 0.01g$		$\pm 0.1g$	
Response time (s)	1.5 - 2.5								0.7 - 1.2			
Ambient temperature and humidity	5 - 40 °C 30 - 85% (No condensation)											
Temperature coefficient of sensitivity (ppm/°C) (10 - 30°C)	± 3								± 5			
Pan size (mm) approx.	108 X 105					170 X 180			108 X 105		170 X 180	
Main body dimensions (mm) approx.	190W X 317D X 78H											
Weight (kg) approx.	3.4					4.6			3.4		4.6	
Display	LCD with backlight											
Rated electric power supply	DC 12V, 1A											
Data I/O	RS-232C											
Pollution Degree	2											
Overvoltage Category	Category II											
Altitude	Up to 2000 m											
Installation Site	device may only used indoors											
AC adapter (primary)	AC 100-240V, 400mA 50/60Hz											
Features	WindowsDirect											
	PSC											
	Clock-CAL											
	GLP/GMP/ISO conformance											
	Analog display, % display, PCS, User unit, Animal weighing, Specific gravity measurement S/W, Checkweighing											

UX Series Model	UX220H	UX420H	UX620H	UX820H	UX1020H	UX2200H	UX4200H	UX6200H	UX420S	UX820S	UX4200S	UX8200S
Capacity	220g	420g	620g	820g	1020g	2200g	4200g	6200g	420g	820g	4200g	8200g
Minimum display	0.001g	0.001g	0.001g	0.001g	0.001g	0.01g	0.01g	0.01g	0.01g	0.01g	0.1g	0.1g
Calibration range with external weights	100 - 220g	100 - 420g	100 - 620g	400 - 820g	500 - 1020g	1000 - 2200g	1000 - 4200g	1000 - 6200g	100 - 420g	100 - 820g	1000 - 4200g	1000 - 8200g
Repeatability (σ)	$\leq 0.001g$					$\leq 0.01g$			$\leq 0.008g$		$\leq 0.08g$	
Linearity	$\pm 0.002g$			$\pm 0.003g$		$\pm 0.02g$			$\pm 0.01g$		$\pm 0.1g$	
Response time (s)	1.5 - 2.5								0.7 - 1.2			
Ambient temperature and humidity	5 - 40 °C 30 - 85% (No condensation)											
Temperature coefficient of sensitivity (ppm/°C) (10 - 30°C)	± 3								± 5			
Pan size (mm) approx.	108 X 105					170 X 180			108 X 105		170 X 180	
Main body dimensions (mm) approx.	190W X 317D X 78H											
Weight (kg) approx.	2.7					2.9			2.7		2.9	
Display	LCD with backlight											
Rated electric power supply	DC 12V, 1A											
Data I/O	RS-232C											
Pollution Degree	2											

3. Specifications

UX Series Model	UX220H	UX420H	UX620H	UX820H	UX1020H	UX2200H	UX4200H	UX6200H	UX420S	UX820S	UX4200S	UX8200S
Overvoltage Category	Category II											
Altitude	Up to 2000 m											
Installation Site	device may only used indoors											
AC adapter (primary)	AC 100-240V, 400mA 50/60Hz											
Features	WindowsDirect											
	GLP/GMP/ISO conformance											
	Analog display, % display, PCS, User unit, Animal weighing, Specific gravity measurement S/W, Checkweighing											

UW Series (Verified model)		UW820SV	UW220HV	UW420HV	UW620HV	UW8200SV	UW2200HV	UW4200HV	UW6200HV
UX Series (Verified model)		UX820SV	UX220HV	UX420HV	UX620HV	UX8200SV	UX2200HV	UX4200HV	UX6200HV
g	Accuracy class	II			I		II		I
	Capacity	820g	220g	420g	620g	8200g	2200g	4200g	6200g
	Verification scale interval (e)	0.1g	0.01g	0.01g	0.01g	1g	0.1g	0.1g	0.1g
	Number of verification scale interval	8200	22000	42000	62000	8200	22000	42000	62000
	Scale interval (d)	0.01g	0.001g	0.001g	0.001g	0.1g	0.01g	0.01g	0.01g
	Range of use	0.5g - 820g	0.02g - 220g	0.02g - 420g	0.1g - 620g	5g - 8200g	0.5g - 2200g	0.5g - 4200g	1g - 6200g
	Tare range (by subtraction)	-820g	-220g	-420g	-620g	-8200g	-2200g	-4200g	-6200g
ct	Accuracy class	II							
	Capacity	N/A	1100ct	2100ct	3100ct	N/A	11000ct	21000ct	31000ct
	Verification scale interval (e)	N/A	0.1ct	0.1ct	0.1ct	N/A	1ct	1ct	1ct
	Number of verification scale interval	N/A	11000	21000	31000	N/A	11000	21000	31000
	Scale interval (d)	N/A	0.01ct	0.01ct	0.01ct	N/A	0.1ct	0.1ct	0.1ct
	Range of use	N/A N/A	0.2ct - 1100ct	0.2ct - 2100ct	0.2ct - 3100ct	N/A N/A	5ct - 11000ct	5ct - 21000ct	5ct - 31000ct
	Tare range (by subtraction)	N/A	-1100ct	-2100ct	-3100ct	N/A	-11000ct	-21000ct	-31000ct
Ambient operating temperature and humidity	10 - 30 °C 30 - 85% (No condensation)								
Pan size (mm) approx.	108 X 105					170 X 180			
Main body dimensions (mm) approx.	190W X 317D X 78H								
Weight (kg) approx.	3.4					4.6			
Display	LCD with backlight								
Rated electric power supply	DC 12V, 1A								
Data I/O	RS-232C								
Pollution Degree	2								
Overvoltage Category	Category II								
Altitude	Up to 2000 m								
Installation Site	device may only used indoors								
AC adapter (primary)	AC 100-240V, 400mA 50/60Hz								
Features	WindowsDirect								
	PSC (UW***V only)								
	Clock-CAL (UW***V only)								
	GLP/GMP/ISO conformance								
	Analog display, % display, PCS, Specific gravity measurement S/W, Checkweighing								

4. Installation

4.1 Choosing the Installation Site

(1) Power supply

- Select an installation site that is near a power source to ensure that the attached AC adapter is used properly. If this is not possible, an optional battery pack is available as a special accessory.
- Verify that the supply power voltage conforms to that indicated on the AC adapter.

(2) Installation site



Caution

Avoid sites where the balance will be exposed to the following:

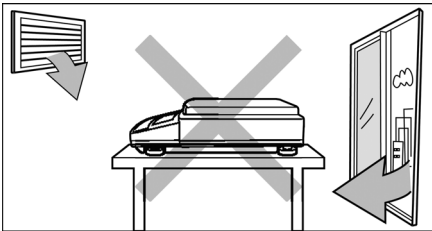

- Air flow from air-conditioner, open window, or ventilator

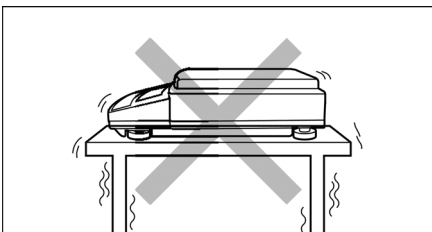

- Vibration

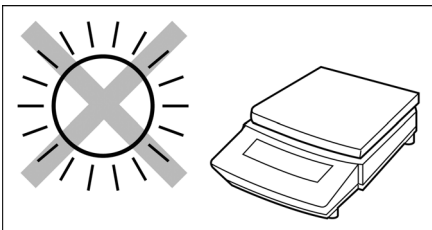

- Direct sunlight

(Continued)

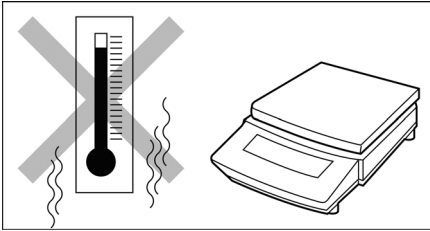

- Extreme temperature, temperature changes or humidity

- Corrosive or flammable gasses
- Dust, wind, electromagnetic waves, or magnetic fields

Install the balance on a strong and stable flat table or floor in the room.

Large capacity balances should be installed on a sturdy floor and table that can support the total load of the balance AND object to be weighed.



Note

Using a verified balance as a legal measuring instrument in using region:

The balance must be used within the temperature range indicated on the verification label.

4.2 Unpacking and Delivery Inspection

Unpack and remove all the items from the delivery box. Check if all the listed items are present and nothing has been damaged. Contact your local distributor in case of damaged or missing items.

Standard packed item and quantity

Type		a. Large pan model	b. Small pan model (Minimum display 0.01g)	c. Small pan model (Minimum display 0.001g)
Model (UW/UX is "UW or UX". Additional suffix may appear after H or S on your balance.)		UW/UX2200H, UW/UX4200H, UW/UX6200H, UW/UX4200S, UW/UX8200S	UW/UX420S, UW/UX820S	UW/UX220H, UW/UX420H, UW/UX620H, UW/UX820H, UW/UX1020H
Balance main body		1	1	1
Pan supporter cap		4	4	4
Pan		1	1	1
AC adapter		1	1	1
In-use protective cover		1	1	1
Windbreak set	Main	0	0	1
	Lid	0	0	1
	Fixing knob	0	0	2
Rubber cap		0	2 (installed on balance main body)	2 (installed on balance main body)
Stainless screw		0	2	2
Instruction manual (incl. explanatory operation sheet)		1	1	1

a. Large pan model

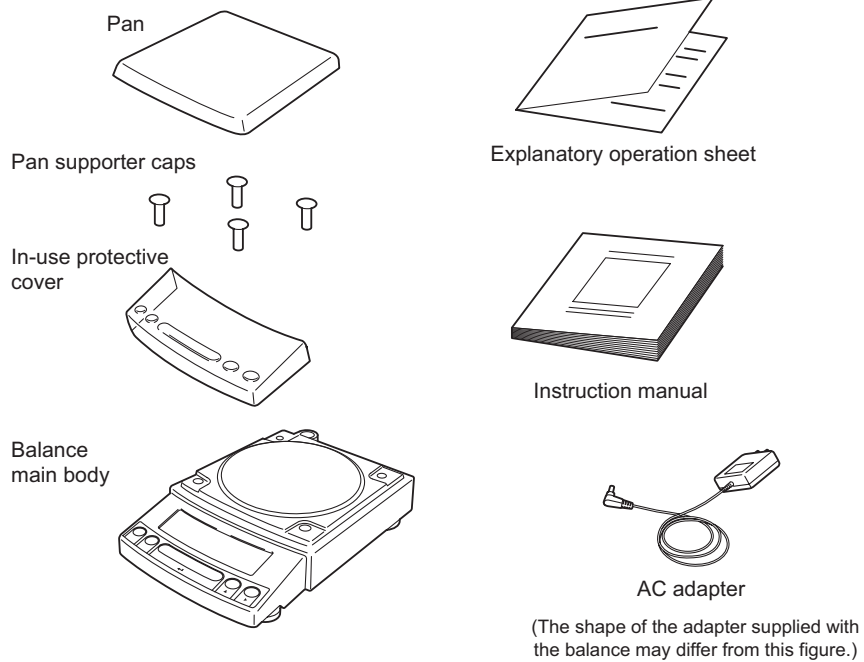

b. Small pan model (minimum display 0.01g)

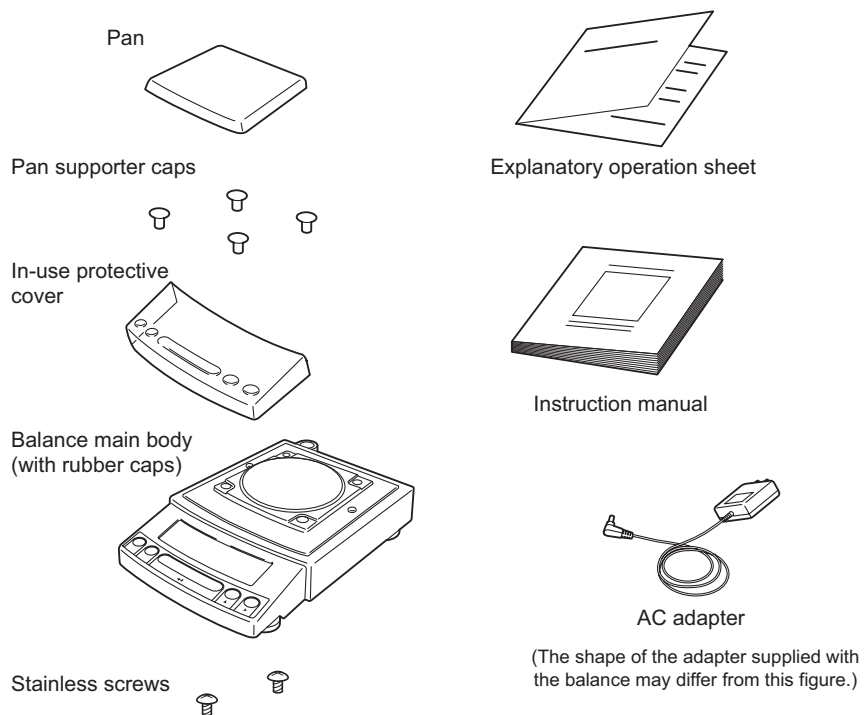

c. Small pan model (minimum display 0.001g)

Windbreak Lid

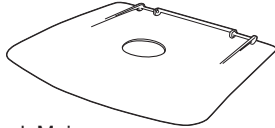

Windbreak Main

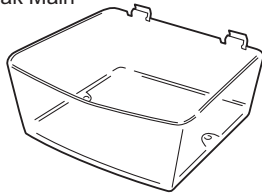

Pan

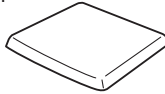

Pan supporter caps



In-use protective cover

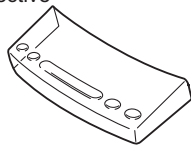

Balance main body (with rubber caps)

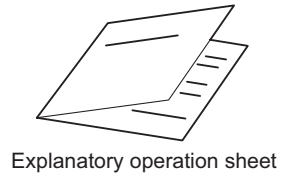
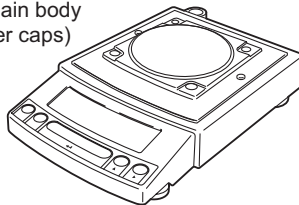

Explanatory operation sheet

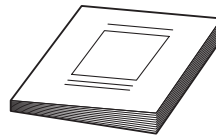

Instruction manual

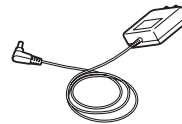

AC adapter

(The shape of the adapter supplied with the balance may differ from this figure.)

Fixing knobs for windbreak



Stainless screws



4.3 Installation

(Start at step 3 when installing a UX series balance. Prepare a plus (+) screw driver for a UW series balance.)

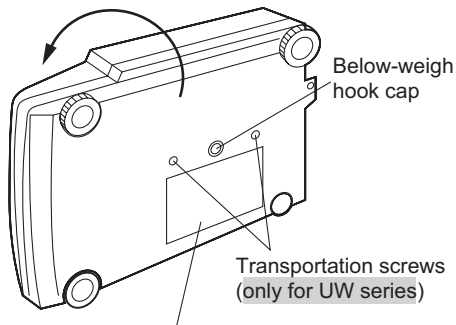

Explanation label (only for UW series)

- 1 Place the balance main body upside down. (UW only)



Caution

Do not operate step 2 with the balance placed on its side.

Place the balance on a smooth surface.

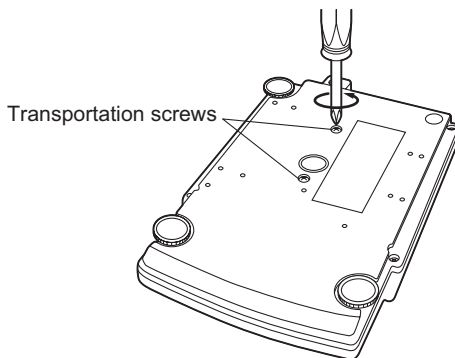

- 2 Referring to the explanation label on the bottom of the balance, turn the two transportation screws **counterclockwise until they tighten again.** (UW only)



Caution

When moving the balance again, turn the two transportation screws clockwise until they tighten. (UW only)

4. Installation

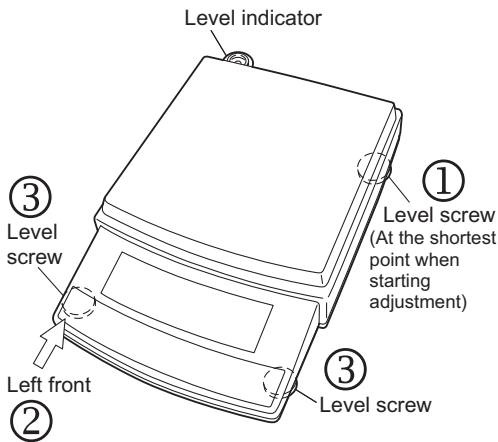

[Large pan model]

3 This balance has three level screws (adjustable feet) at the right front, left front and right rear corners.

Turning a level screw clock-wise stretches the leg to raise the balance body there. Turning anti-clockwise withdraws the leg and lowers the balance body.

The level indicator locates at left rear. The bubble of it is off center when the balance is not placed level.

(1) At first, adjust only with the two front screws. Then, turn the right rear level screw ① anti-clockwise to withdraw its leg completely.

(2) While adjusting level screws and observing the bubble, gently press the left front corner of the balance ② so that both front level screw feet ③ are touching the table surface.

(3) Bubble moves to the highest position. Therefore, adjust level screws ③ so that the balance main body is lowered in the direction of the bubble.

Case 1: Right front of the balance is too high. Turn right front level screw anti-clockwise so that the bubble moves towards center.

Case 2: Front of the balance is too low. Turn both front level screws clockwise so that the bubble moves towards center.

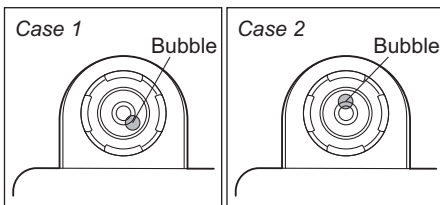

(4) When the bubble has come to the center of the red circle, turn the right rear level screw clockwise until its foot softly touches the table surface. Verify the balance sits stable with four feet.

- 4** Install the pan. With small pan model with minimum display of 0.001g, the standard windbreak is also installed here.

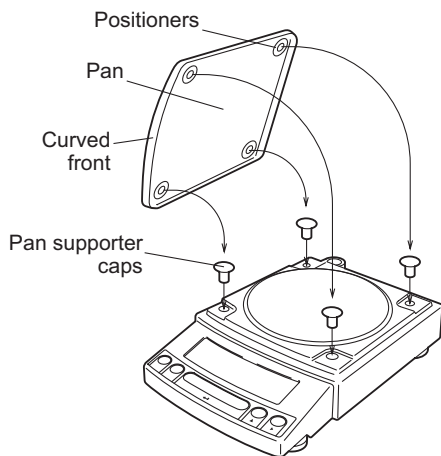

a. Large pan model

Insert the four pan supporter caps into the holes in the top of the balance. Place the pan gently on pan supporter caps. Positioners of the pan must fit pan supporter.

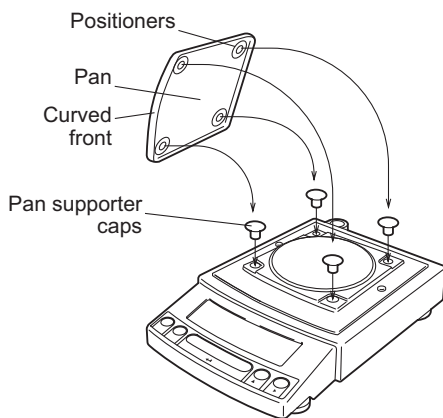

b. Small pan model

(minimum display 0.01g)

Insert the four pan supporter caps into the holes in the top of the balance. Place the pan gently on pan supporter caps. Positioners of the pan must fit pan supporter.

The rubber caps on top of the main body may be replaced with the stainless screws so that it will be more secure when exposed to organic solvent.

c. Small pan model

(minimum display 0.001g, windbreak standard)

- (1) Pull out the two rubber caps from the main body top.

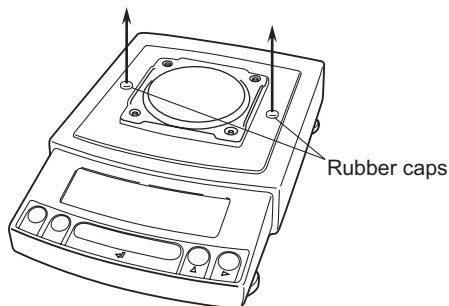

4. Installation

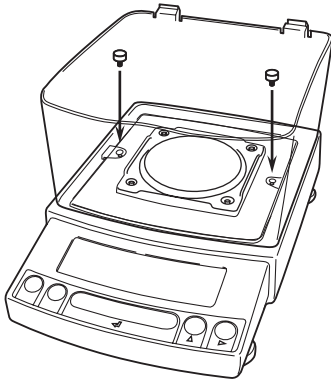

- (2) Fit windbreak main on top of the balance main body, and fasten it with two fixing knobs.

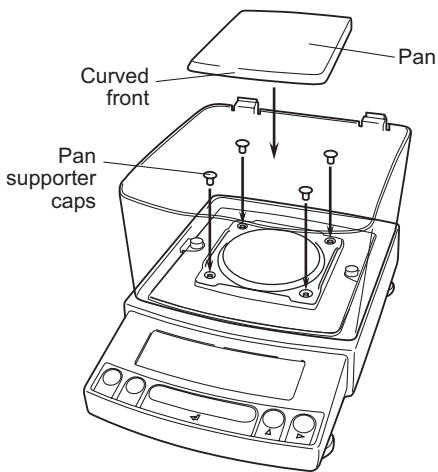

- (3) Insert the four pan supporter caps into the holes in the top of the balance. Place the pan on them. Positioners on the pan must fit pan supporter caps.

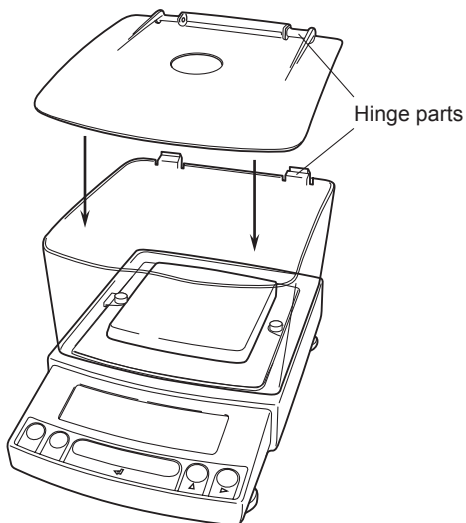

- (4) Place windbreak lid on top of windbreak main fitting the hinge parts.

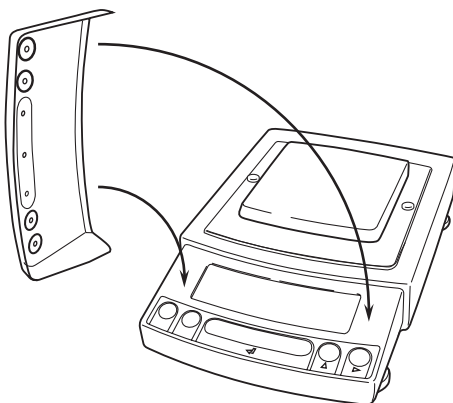

- 5** If you use in-use protective cover, peel off the paper to expose the adhesive on it, then fit it on the display and key part. Press the adhesive parts gently.



Note

Using a verified balance as a legal measuring instrument in using region:

Legal regulations require a verified balance be sealed. This control seal is a self-destructive adhesive label. This seal is irreparably damaged invalidating the verification, if you attempt to remove it. The balance must then be re-verified before it is used for legal measurements.

4.4 Turning ON the Power

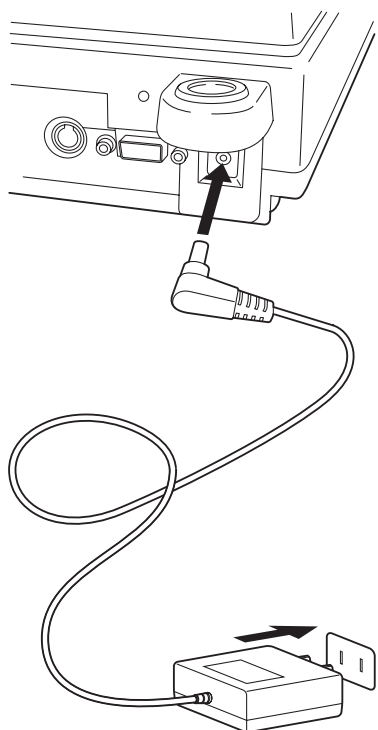

1 Insert the plug of the AC adapter into the DC IN connector on the rear of the balance.

2 Insert the AC adapter into the power source. The balance self-check is activated and the following messages are displayed in the order indicated. First, the software version number is displayed.

[1.30:00], [CHE 5], [CHE 4], [CHE 3], [CHE2],
e.g. of the version number
 [CHE1], [CHE0], prompting all the symbols and segments, [oFF] ([CHE 5] and [CHE 4] are not displayed for the UX series).



Note

A power cable may be necessary to connect the AC adapter to the power source, depending on the type of the AC adapter.

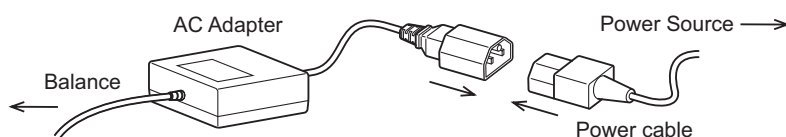

3 Press **[POWER]** key. All the symbols and segments prompt and then the display changes to indicate the gram-display. The backlight is illuminated.



Note

When using the optional battery pack (special accessory), connect the fully charged battery pack to the DC IN connector of the balance using the cable attached to the battery pack.

4.5 Span Calibration



Note

Using a verified balance as a legal measuring instrument in using region:

Span calibration must be performed once the balance is installed and before using the balance as a legal measuring instrument in using region. Span calibration must be performed with the internal calibration weight to maintain the verification valid. The balance must be connected to power and warmed up for at least 2 hours prior to span calibration and use as a legal measuring instrument.

It is necessary to calibrate the balance after it is moved.

Verify that the balance is stable before performing the span calibration. To achieve a very stable state, ensure that the balance has been turned on with the gram-display for at least one hour, that the temperature is constant, that there are no breezes or vibrations and that the balance is in an area isolated from the normal traffic flow.

UW series [Span Calibration Using the Built-in Weight]

- 1** Verify that the balance is in gram-display and that the pan is empty.
- 2** Press the [CAL] key once. "i-CAL" is displayed.
- 3** Press the [O/T] key. After "i-CAL3"... "i-CAL1", "Set", "CAL End" are displayed indicating the completion of span calibration, the gram-display will appear.

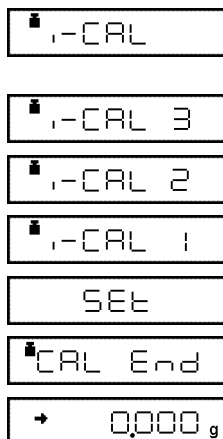

This is the standard calibration type. Refer to [10.3.1](#) for use of external weights.

**Note**

Span calibration should be performed again :
 when the location of the balance is changed,
 when the room temperature changes considerably,
 periodically, according to the quality control plan of the user.

UX series [Span Calibration Using External Weights]

**Note**

Not applicable to a verified balance as a legal measuring instrument in using region.

- 1** Verify that the balance is in gram-display and unload the sample from the pan.
- 2** Press the **[CAL]** key once. "E-CAL" is displayed.
- 3** Press the **[O/T]** key.
The value of the correct calibration weight to be loaded is displayed and blinks.
- 4** Load the indicated calibration weight and press the **[O/T]** key.

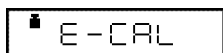

(Example)

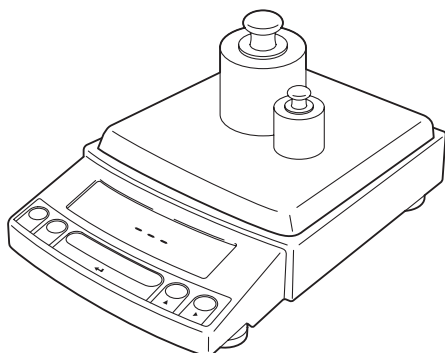
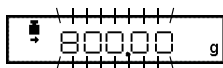

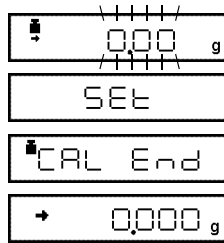

- 5** When the zero display blinks, unload the weight from the pan and press the **[O/T]** key. "Set" is displayed briefly to indicate completion of span calibration. Then the gram-display will return.



Note

Span calibration should be performed again :
when the location of the balance is changed,
when the room temperature changes considerably,
periodically, according to the quality control plan of the user.

5. Basic Operation

5.1 Weighing

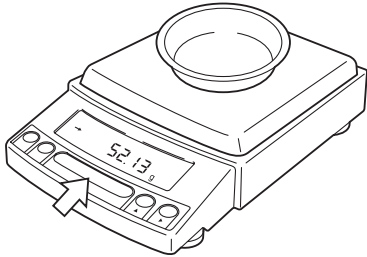

- 1 If a weighing vessel (tare) is used, place it on the pan and wait for the stability mark to prompt.

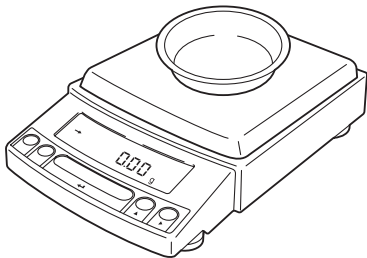

- 2 Press the [O/T] key to zero the display. (This operation is called taring.)

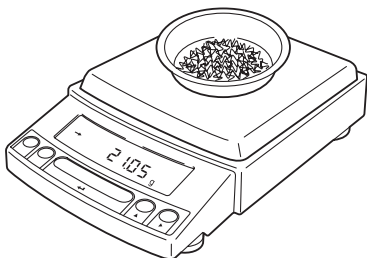

- 3 Place the object to be weighed on the pan.
- 4 Read the displayed value after the stability mark is displayed.



Note

Using a verified balance as a legal measuring instrument in using region:

✕ Indicates that the balance is set exactly to “Zero” with the zero-setting function ($\pm 0.20e$; e = verification scale interval).

**Note****Using a verified balance as a legal measuring instrument in using region:**

The balance must be used within the temperature range indicated on the verification label.

When PSC (refer to 10.3.2), fully-automatic span calibration, is not activated, operator must carry out span calibration with the built-in weight (refer to 4.5) upon blinking of the Weight Symbol.

Error Displays During Weighing

	Overload: Weighing capacity has been exceeded.
	Negative Overload: The load on the balance is too light. The pan is not adjusted properly.

5.2 Changing the Unit Display

Every time the [UNIT] key is pressed, the unit display changes sequentially among those set-up in 12.1 Unit Display Set-up. Gram, %, and PCS have been set-up before delivery.

**Notes**

- Before a unit can be displayed it must be registered in 12.1 Unit Display Set-up.
- The registered units are displayed sequentially according to the order of the 12.1 Unit Display Set-up.

6. WindowsDirect Function

6.1 Introduction: *Experience it!*

The UW/UX series balance can transfer data directly to a computer running MS-Excel, mass input window of analytical instrument software or other applications on Windows® OS, as if the displayed value were typed from the keyboard to the cursor position. This function is called WindowsDirect. As this function directly accesses the Windows® OS, communication software-installation troubles are eliminated. A cable and a few simple settings are all that is needed to enable data transmission from the balance. For bi-directional communication between the balance and the computer, software is required. WindowsDirect does not send commands from the computer.

- Only numerical values can be transferred through WindowsDirect.

6.2 Set Up WindowsDirect

Simple settings are made for the balance and the computer. Connection is by RS-232C cable ([15.2.1](#)) specified by Shimadzu.

If bi-directional communication software is used: WindowsDirect function should be turned off. Set up the optimal communication parameters for the software according to "15.3 Communication setting".

6.2.1 Setting Up the Balance

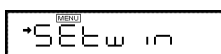
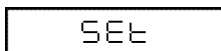
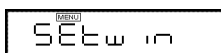

- 1** Press the **[MENU]** key twice from the gram-display. "Setwin" appears.
- 2** Press the **[O/T]** key. Verify the stability mark is illuminated with "Setwin" display. All the communication settings for WindowsDirect have been made.
- 3** Go to "STAND-BY" by pressing the **[POWER]** key several times and unplug the AC adapter from the balance. Unplugging the balance once is necessary after the above setting.



Notes

- Individual communication parameters can be changed at any time using the communications settings menu. If WindowsDirect communication settings have been previously made, the → (stability mark) may appear with the "SEtwin" display even after communication settings are changed and become invalid for WindowsDirect. To restore WindowsDirect optimal settings, first go to the "SEtwin" display and remove the stability mark by pressing the **[O/T]** key. This restores the default communication settings. Then, reset "SEtwin" following the procedure described in [6.2.1](#).
- Refer to [15.3](#) for details of communication settings.

6.2.2 Cable Connection

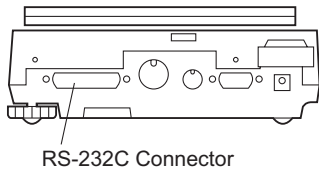

- 1** Verify the balance display is "STAND-BY".
- 2** Turn off the computer and remove power from the balance.
- 3** Connect the RS-232C cable to the balance.
- 4** Connect the RS-232C cable to the computer.

When using WindowsDirect, use a Null modem cable of one of the below wirings.

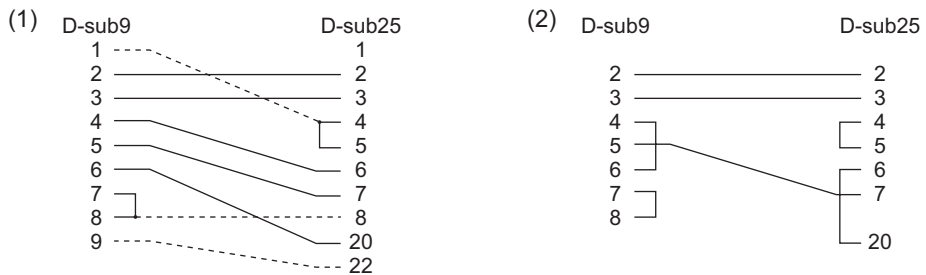

--- is not necessarily required.

A cable of the (1) wiring (including --- wiring) is available as an optional accessory.

RS-232C Cable 25P-9P (1.5m) P/N 321-60754-01

6.2.3 Setting Up the Computer

(leave the balance unplugged)

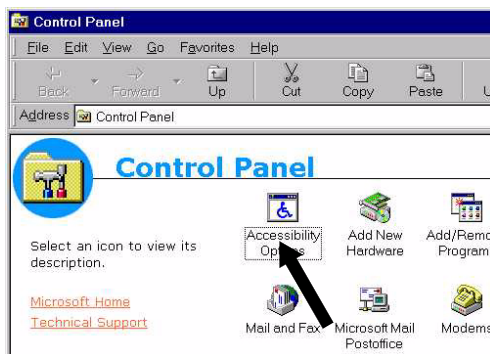

- 1** Turn ON the power to the computer and start Windows®*.
- 2** Click "Start", choose "Settings", and "Control Panel".
- 3** Select "Accessibility Options."
- 4** Verify that there are no check marks for any items on all five tabs including "General."

6. WindowsDirect Function

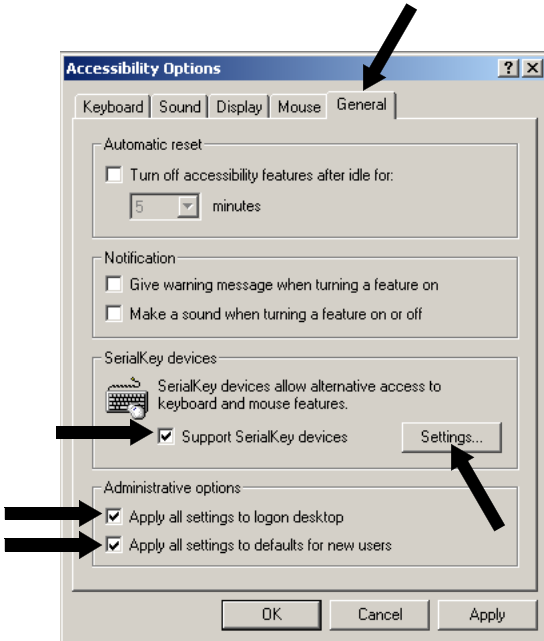

5 Put a check mark at “Support Serialkey device” in the “General” tab. This should be the only check mark on all the tabs of Accessibility Options unless “Administrative options” appears in the “General” tab. Put check marks at both the items of “Administrative options” to maintain the settings even after restarting Windows®.

6 Open “Settings”.

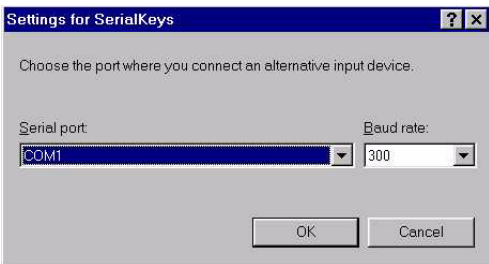

7 Select the serial port corresponding to the RS-232C port of your personal computer. (Serial port: any one of COM1 to 4. Usually, COM1)

8 Select a “Baud rate” of 300.

9 Click “OK”.

10 Click “Apply” and wait.

11 Click “OK”.

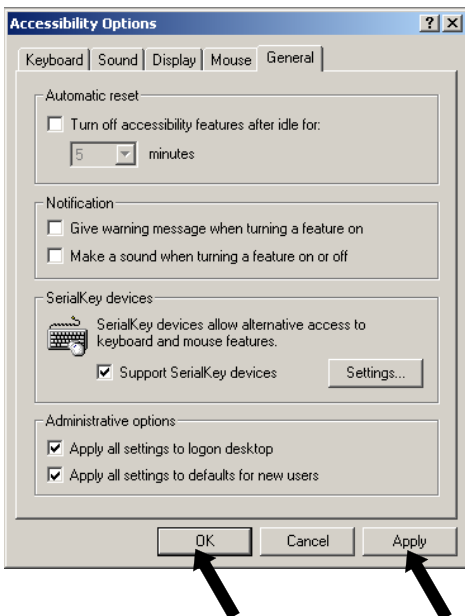

6.2.4 Start and Checking Operation

- 1 Confirm Windows® is free from any application.
- 2 After Windows® has completely started, connect power cord from the AC adapter to the balance, when “OFF” is displayed, press the **[POWER]** key. The mass display appears.



Note

Turning ON the balance before Windows®* is completely activated may cause incorrect operation.

- 3 Open the “Note pad” accessory in Windows®* (or start the application you wish to use).
- 4 Press the **[PRINT]** key of the balance. Verify that the numeric value displayed on the balance appears at the cursor position on the screen of computer. The effect is the same as typing the value from the computer keyboard and pressing the ENTER key. Characteristics indicating the unit of measure are not sent to the computer.



Note

To **output date and time** from the balance, press and hold the **[PRINT]** key for about 3 seconds.

- 5 Test combination with Auto Print function, if you wish to use it. (Refer to [13.3](#))
- 6 End the operation using the standard close or exit procedure.

6.3 Troubleshooting the WindowsDirect Communication Function

If the WindowsDirect communication function doesn't run properly, check the following points. If this doesn't resolve the problem, contact your Shimadzu representative.

Q1 WindowsDirect communication has been set but it is not operating at all.

A1

- Check the type of communications cable used for the connection (Shimadzu authorized part or another part available on the general market) and the soundness of the connection.
- If a USB serial converter is used, depending on the circumstances at the setup there is a possibility that it has been automatically set to a COM port number higher than 4, and in this case you should reassign it to a COM port number that can be used by serial key devices (COM1 to COM4).
- It is possible that the driver used as an accessory with the USB serial converter has not been set up properly. Try uninstalling the driver and installing it again.
- Some notebook PCs feature a setting for disabling RS-232C ports as a power-saving measure. Before trying to use the WindowsDirect communication function, make the setting that enables the use of RS-232C ports.
- Communications with other applications and PCs via a LAN may interfere with the serial key device settings. Try using WindowsDirect communication without using the LAN.

Q2 The WindowsDirect communication function won't work after I restart the PC.

A2

- Some PCs don't recognize that a serial key device has been set when they start up. For details on how to deal with this, contact your Shimadzu representative.

Q3 I want to use the WindowsDirect communication function with Windows Vista or Windows 7.

A3

- Windows Vista doesn't have the serial device setting screen that is required to set the WindowsDirect communication function. For details on the setting, contact your Shimadzu representative.

Q4 Data is input to the PC as garbled characters.

A4

- Either the balance or the PC is not set for the WindowsDirect connection function. Make the settings again.

Q5 When data is input into Excel, the cursor doesn't move to another cell.**A5**

- If a function for conversion to 2-byte characters is available in Windows, turn the setting for this function off.
- Click the [Edit] tab under [Options] in Excel and check [Move selection after Enter] (if cells move in response to keyboard input there is no problem).
- Check the input data in another application (e.g. Notepad).

Q6 The operation is sometimes abnormal.**A6**

- Depending on the processing capability of the PC, malfunctions may occur if the communications speed is high. Set 300 bps for the communication speed. Malfunctions may also occur if the interval for data transmission from the balance is too short. Ensure that one batch of data is displayed on the screen before the next batch of data is sent. And if there is limited processing capability, don't use the continuous output function.
- When data is sent from the balance, don't touch the PC's keyboard or mouse.

7. Menu Item Selection

7.1 What is the Menu?

The UW/UX series balance has many functions that can be selected to meet the requirements of the user. Menu Item selection is used to program these functions.

7.2 Menu Map

The menu of the UW/UX balance consists of seven groups and four levels. The Menu Map shows the structure clearly with menu item numbers to help access the desired function. Refer to the Menu Map on the operation explanatory sheet or in appendix when programming the functions in Chapter 8 through 15.

7.3 Menu Item Selection Procedure

This instruction manual identifies each menu item by a number. For example, the menu items of “Stability Detection Band” of “11. Environment” are **27** through **33**.

Find the function to be programmed in the Menu Map, referring to the item number in square, **No.**

To reach the item, operate the keys on the balance.

- (1) Press the **[CAL]** key to cycle through the items within a menu level.
(↓ In the Menu Map)
- (2) Press the **[O/T]** key to choose the current item or move to the next menu level.
(→ In the Menu Map)
- (3) Press the **[POWER]** key to move back one menu level.
- (4) Press and hold the **[POWER]** key to return to the gram-display.



Note

The **[MENU]** symbol is displayed during Menu Item selection.

Example: Select “Stability Detection Band” “4 counts”.

The menu item number is **29** on the Menu Map.



- 1** Press the **[CAL]** key repeatedly from the gram-display until “SEL:EAUS” and some symbols are displayed and “E” blinks.



Note

Before entering the menu, set the balance to the gram-display using the **[UNIT]** key. It is also possible to enter the menu from other weighing units involving no further setting with the **[UNIT]** key.



- 2** Press the **[O/T]** key. “E” is selected and display changes to “→E-AbtP8” and “→” blinks.



- 3** Press the **[CAL]** key twice to make “b” blink.

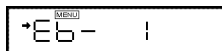

- 4** Press the **[O/T]** key. “b” is selected and “Eb-1” is displayed. Stability mark is lit if Eb-1 is currently set.

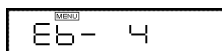

- 5** Press the **[CAL]** key twice. “Eb-4” is displayed.

7. Menu Item Selection

Important Note on Menu Item Selection

Even the desired menu item is reached and displayed, it is not yet set unless Stability mark (➔) is prompted with it. Do not fail to **press [O/T] key** to put Stability mark before returning to the mass display.

SEt

→Eb- 4

➔ 0.000 g

6 Press the **[O/T]** key to select this item. “SEt” is displayed and the stability mark now appears with “Eb-4”.

7 Return to the desired menu by pressing the **[POWER]** key. If pressed and held, it returns to the gram-display.

Once the menu items have been set based on the installation environment and weighing purpose, it is not necessary to select the menu items each time the balance is used. Once the contents of the menu are set, they are stored even if the balance is turned OFF or if the power is disconnected.

Major Menu Description

Menu Group	Symbol that blinks at beginning of menu	Menu Items Included
1		Calibration
2	(Graphic display)	Analog display, checkweighing, and target weighing
3	E	Installation environment and taring
4	A	Application measurements and automatic output
5	U	Unit conversion and specific gravity measurement
6	S	Clock set-up and calibration record
7		Communication with computer and external devices.



7.4 Setting Numeric Values

Some of UW/UX series balance menu items require numeric value setting.

For example, external calibration weight input, thresholds for checkweighing and reference density in specific gravity measurements (see 10.2, 10.3, 13.1, 13.5, 14.1, 14.2, 14.4 for detail of each item.)

The values can be set using the balance keys.

In a menu used to set numeric values, **[MENU]** and **#** are both prompted and the digit to be input blinks.

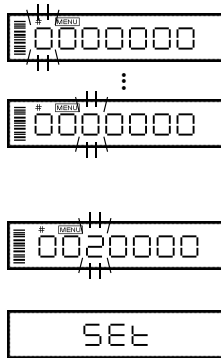

- 1** Press the **[UNIT]** key to increase the value of the blinking digit by one. (0.....9, 0)
- 2** Press the **[PRINT]** key to move the blinking digit one place to the right.
- 3** Press the **[O/T]** key to store the displayed value in the balance memory.
“SEt” is displayed when the value has been successfully saved.
“Err” is displayed when the balance failed to save the value.
- 4** Press the **[POWER]** key to stop numeric entry.
“Abort” is displayed briefly and the display returns to the menu, one level up.



Notes: Setting a Decimal Point

A decimal point is only used when setting units for solid density weighing, liquid density weighing or when setting the multiplier for the user-defined unit. Set the decimal point while setting numerical values as follows.

- Press the **[PRINT]** key repeatedly until the last digit is blinking. Press the **[PRINT]** key once more to initiate decimal point setting mode. The ▼ symbol or current decimal point blinks.
- Press the **[UNIT]** key to move the blinking decimal point one digit at a time to the desired position.
- Press the **[O/T]** key to set the decimal point position.
“SEt” is displayed briefly to indicate that the setting is completed.

Use the optional AKB-301 Application Keyboard to easily set numerical values and decimals.

7.5 Related Useful Functions

7.5.1 Last Menu Recall

This function is convenient when an application requires frequent changes to a specific menu item. During mass display or menu selection, press and hold the **[CAL]** key for approximately three seconds. The last menu item that was changed or set is displayed.

7.5.2 Returning to the Default Settings (menu reset)

The procedure below describes how to reset the menu and return to the default settings.

Default settings are indicated with the * symbol in the Menu Map.

Select menu item **72** to reset the menu.

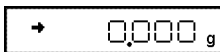
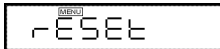
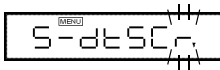
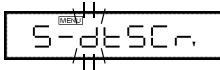

- 1** In the gram-display, press the **[CAL]** key repeatedly until the “S” of “SEL:EAUS” blinks.
- 2** Press the **[O/T]** key. The Menu Group 6 is selected.
- 3** Press the **[CAL]** key repeatedly until the “r” in “S-dtSCr,” is blinking.
- 4** Press the **[O/T]** key to display “rESEt?” (“?” without the dot).
- 5** Press the **[O/T]** key again. “rESEt” is displayed to indicate menu reset completion.
- 6** Press the **[POWER]** key several times (or hold it for approximately 3 seconds) to return to the gram-display.



Notes

- The settings made in “[15.4 Decimal Point Symbol in Output Data](#)” and “[8.2 Date Output Style](#)” are not be cleared with Menu reset.
- Environmental setting of Pouring mode ([11.2](#)) is not cleared with Menu reset.
- Operational condition setting of Animal Weighing mode ([14.6](#)) returns to the default (Cond 1).

7.5.3 Menu Lock

The “Menu Lock” function locks the menu item selection to protect the current settings from undesired alterations.

Menu Lock can be activated or released only at the “oFF” display immediately after the balance is connected to the power.

(How to lock the menu)

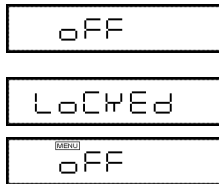

- 1** Disconnect power from the balance once. Then, reconnect power to the balance.
- 2** Press and hold down the **[CAL]** key for about three seconds during “oFF” display. “LoCKEd” is briefly displayed to indicate that the menu is locked.



Notes

- **[MENU]** is illuminated during “oFF” display or STAND-BY while Menu Lock is activated.
- “LoCKEd” is displayed upon an attempt of access to the menu including releasing the currently set function, while Menu Lock is activated.
- All the menu item selections including WindowsDirect setting (6.2.1) are locked. The operational condition setting for Animal Weighing (14.6) and the environmental setting for Pouring mode (11.2) are also locked under Menu Lock.
- Change of minimum display (See 9.2, 14.1, 14.2) is not locked by Menu Lock.
- Change of unit display (See 5.2) is not locked by Menu Lock.

(How to remove Menu Lock)



- 1** Disconnect power from the balance once. Then, reconnect power to the balance.
- 2** When “oFF” is displayed, press and hold down the **[CAL]** key for about three seconds.
- 3** “rLEASE” is briefly displayed to indicate that the menu lock has been turned off.

8. Built-in Clock Set-up

The built-in clock has to be set up in advance if a calibration record is to be produced or Clock-CAL function is to be used.

8.1 Date

(Example)

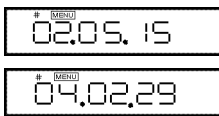

- 1 Select menu item **63** and set the last two figures of the year, month and day, using the **[UNIT]** and **[PRINT]** keys.

Example: May 15th, 2002, set as "02.05.15"

Example: February 29th, 2004, set as "04.02.29"

- 2 Then press the **[O/T]** key.



Notes

- The built-in clock corrects for the leap year automatically.
- The moment the **[O/T]** key is pressed to finish setting, seconds are set to zero. If the is set after setting the time, the second value will be incorrect. It is important to set the first and then the time, or to correct the seconds value using the \pm second correcting function described in section 8.3.

8.2 Date Output Style

The order of the year, the month and the date in the external output can be selected from three styles. The setting made here is not reflected on the display of the balance.

To output in the YYYY-MM-DD order, select menu item **63a**. [y.m.d]

To output in the DD-MM-YYYY order, select menu item **63b**. [d.m.y]

To output in the MM-DD-YYYY order, select menu item **63c**. [m.d.y]



Notes

The setting made here on "Date Output Style" will not be cleared with Menu reset (See 7.5.2).

8.3 Time

Select menu item **64** and set the time in the 24 hour system using the **[UNIT]** and **[PRINT]** keys, then press the **[O/T]** key.

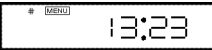
(Example) 

Example: 1:23 in the afternoon, is set as "13:23".



Note

The moment the **[O/T]** key is pressed seconds are set to 00.

8.4 Setting Display During Stand-by

Determine what is to be displayed during stand-by.

To display the time during stand-by, select menu item **65**.

To display the date during stand-by, select menu item **66**.

To display neither during stand-by, select menu item **67**.



Notes

- **Seconds display function:**
Press the **[UNIT]** key to switch on/off of the display of seconds.

9. Display Selection

9.1 Bar graph display

The relative amount of the load on the pan is displayed in the bar graph. This feature helps to prevent errors due to OL (overload) status. This is called Full Scale mode. This display can not be used with the Checkweighing or Target mode.

Select the menu item **[11]** to set up Full Scale mode.

(Examples) (1) (2)



A bar displayed in the lower areas of the scale indicates that the load on the pan is small. (1)

A bar displayed up to the upper areas of the scale indicates that the load on the pan is close to the weighing capacity. (2)

Not to display bar graph, select menu item **[21]**.

9.2 Changing the Minimum Display Digit (10d:1d)

Not applicable to a verified balance as a legal measuring instrument in using region

It is possible to decrease the minimum balance display by one decimal place if necessary.

- 10d -

- 1d -

1 Press and hold the **[UNIT]** key for approximately three seconds. “- 10d -” is displayed and the display is decreased by one decimal place.

2 Press and hold the **[UNIT]** key for approximately three seconds. “- 1d -” is displayed and the display returns to the original number of decimal places.



Note

The location of the decimal point in the display does not shift. In the “10d” display, the last digit is empty.

10. Calibration

10.1 What is calibration?

Calibration is required to accurately weigh items with an electronic balance accurately. Calibration should be performed:

- When the location of the balance is changed, even within the same room.
- When the room temperature changes considerably.
- Periodically, according to the quality control plan of the user.

Terms used in this manual:

- Span Calibration:** Adjustment of the balance to specifications using two weight values; zero and an appropriate value for the balance capacity.
- Calibration Check:** Comparing the current calibration weight reading to the calibration weight reading after the last span calibration.
- Calibration:** Pertains to both span calibration and calibration check.



Caution

Never plug off the balance when the following messages are displayed.
“i-CAL x”, “i-tEst x”, “wAit”, “Abort”, “CAL E x”(“x” represents a number).
With UW series, displaced built-in weight may cause damage to the mechanism.

10.2 Calibration Execution



Notes

- Setting before shipment is as the following:
 UW series: Span calibration using the built-in weight
 UX series: Span calibration using external weights
 The type of calibration can be changed (See [10.3](#)).
- Calibration will not be performed when the weight on the pan is not near zero, or the balance is not stable.

10.2.1 Span Calibration Using the Built-in Weight (UW Series Only)

The balance is adjusted using the built-in calibration weight.

:

- 1** Verify that the balance is in mass display and that the pan is empty.
- 2** Press the **[CAL]** key once. “i-CAL” is displayed. (If “i-CAL” is not displayed, return to mass display and select menu item **[1]**.)
- 3** Press the **[O/T]** key.
 “i-CAL3”, “i-CAL2”, “i-CAL1”, “Set” and “CALEnd” will be displayed in that order. Then the mass display will appear indicating the completion of span calibration.

10.2.2 Calibration Check Using the Built-in Weight (UW Series Only)

The difference of the weighed built-in weight from the last calibration will be displayed. However, the balance will not be calibrated.

1 Verify that the balance is in mass display and that the pan is empty.

2 Press the **[CAL]** key once to display “i-tEST”.
(If “i-tEST” is not displayed, return to mass display and select menu item **[2]**.)

3 Press the **[O/T]** key.

The display changes sequentially from “i-tEST 2” to the “d xxx” display. (xxx indicates a numeric value)
This “d” value indicates the difference between the current calibration weight reading and the calibration weight reading at the last span calibration.

4 To perform span calibration, change the “d” value to zero, by pressing the **[CAL]** key.
--Otherwise, Press the **[O/T]** key to avoid changing the “d” value to zero. (Pressing the **[POWER]** key interrupts calibration and does not change this value to zero.)

“CALEnd” is displayed, indicating the completion of the calibration check.



Note

Changing the “d” value to zero is equivalent to performing span calibration.



Notes

- Examples for interpreting the results of a Calibration Check:

“d” Value	Actual Mass	Displayed Mass
-0.3	3000g	2999.7(3200g/0.1g balance)
+0.21	400g	400.21(420g/0.01g balance)

- Error codes that may be displayed:

“d ouEr” (d OVER) indicates that the “d” value is 1000 counts or more.

“d UndEr” indicates that the “d” value is -1000 counts or less.

10.2.3 Span Calibration Using External Weights

Not applicable to a verified balance as a legal measuring instrument in using region

The balance is adjusted using your external standard calibration weight(s).

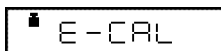

(Example)



- 1** Verify that the balance is in mass display and that the pan is empty.
- 2** Press the **[CAL]** key once. "E-CAL" is displayed.
(If "E-CAL" is not displayed, return to mass display and select menu item **[3]**.)
- 3** Press the **[O/T]** key.
The value of the correct calibration weight to be loaded is displayed and blinks.



Changing the Calibration Weight to be Used

Pressing the **[CAL]** key allows changes to the weight value. Modify the value using the **[UNIT]** key and **[PRINT]** key, then press the **[O/T]** key. Refer to 7.4 for how to make numerical input. To interrupt modification, press the **[POWER]** key. Calibration range with external weights is designated to each model. Refer to "3. Specifications" for calibration range. Attempt of inputting an invalid calibration weight value causes an error message.

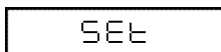
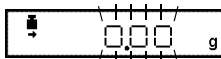

- 4** Load the indicated calibration weight and press the **[O/T]** key.
- 5** Shortly, zero display blinks. Unload the weight from the pan and press the **[O/T]** key.
"SEt" is displayed briefly to indicate completion of span calibration.



Note

OIML Class E2 or F1 calibration weight is recommended for calibration, depending on your accuracy demand.

10.2.4 Calibration Check Using External Weights

Not applicable to a verified balance as a legal measuring instrument in using region

The difference of the weighed external weight from last calibration will be displayed. However the balance will not be calibrated.

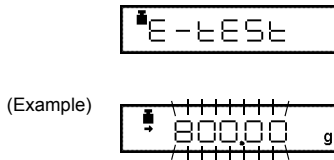

- 1** Verify that the balance is in mass display and that the pan is empty.
- 2** Press the **[CAL]** key once to display “E-tEst”.
(If “E-tEst” is not displayed, select menu item **4**.)
- 3** Press the **[O/T]** key.
The value of the correct calibration weight to be loaded is displayed and blinks.



Changing the Calibration Weight to be Used

Pressing the **[CAL]** key allows changes to the weight value. Modify the value using the **[UNIT]** key and **[PRINT]** key, then press the **[O/T]** key. Refer to [7.4](#) for how to make numerical input. To interrupt modification, press the **[POWER]** key. Calibration range with external weights is designated to each model. Refer to “[3. Specifications](#)” for calibration range. Attempt of inputting an invalid calibration weight value causes an error message.

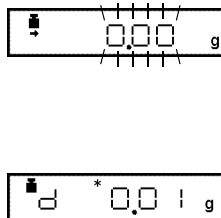

- 4** Load the indicated calibration weight and press the **[O/T]** key.
The zero display blinks.
- 5** Unload the weight from the pan and press the **[O/T]** key.
The display changes to the “d xxx” display.
(xxx indicates a numeric value)
- 6** To perform span calibration, change the “d” value to zero by pressing the **[CAL]** key.

Otherwise, press the **[O/T]** key instead of changing the “d” value to zero. (Pressing the **[POWER]** key interrupts calibration and does not change this value to zero.)

“CALEnd” is displayed, indicating the completion of the calibration check.



Note

Changing the “d” value to zero is equivalent to performing span calibration. Refer to [10.2.2](#) for interpreting the results of a Calibration Check.

10.3 Calibration Setting

10.3.1 Selecting the Calibration Type

Set the calibration type that will be used in Calibration Execution.

To set up “Span calibration using the built-in weight”,(UW only)	Select menu item 1 .
To set up “Calibration check using the built-in weight”,(UW only)	Select menu item 2 .
To set up “Span calibration using external weights”,	Select menu item 3 .*
To set up “Calibration check using external weights”,	Select menu item 4 .*

***Not applicable to a verified balance as a legal measuring instrument in using region**

10.3.2 PSC Fully-automatic Calibration (UW series only)

With the PSC function, span calibration is performed automatically using the built-in calibration weight when the balance detects a temperature change that would affect weighing accuracy.

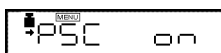

1 To turn ON the PSC function, Select menu item **5**.

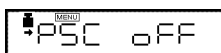

2 To turn OFF the PSC function, Select menu item **6**.



Notes

- Blinking calibration symbol indicates an automatic calibration is about to start.
- If PSC starts while the balance is in use, press the **[POWER]** key to abort that cycle.



Note

Using a verified balance as a legal measuring instrument in using region:
When PSC, fully-automatic span calibration, is not activated, operator must carry out span calibration with the built-in weight (refer to [10.2.1](#)) upon blinking of the Weight Symbol.

10.3.3 Clock-CAL Fully-automatic Calibration (UW series only)

Span calibration is performed automatically using the built-in calibration weight at up to 3 specific, pre-set times during each day. The user selects the times. This function is named Clock-CAL.

It is possible to set up to three specific times for Clock-CAL (“tCALt1”, “tCALt2”, and “tCALt3”). Use the 24 hour system to set menu items **7**, **8**, and **9**. Setting to “00:00” releases the function.



Notes

To execute Clock-CAL, all of the following conditions must be satisfied at the set time. If these conditions are not satisfied within one minute, the automatic span calibration is not executed and that cycle is skipped.

- The balance must be in mass display or the standby mode.
- The balance must be stable.
(The stability symbol must be illuminated during mass display.)
- Load on the pan should be near zero.
- The balance should not already be in the process of span calibration.

Example: Setting “tCAL t1” to twelve noon.

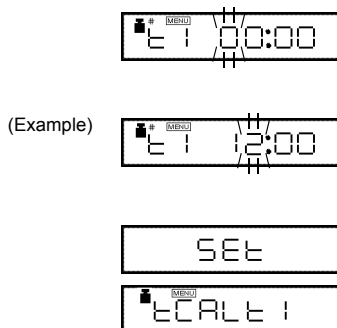

- 1 Select menu item **7**.
- 2 Set the desired time. (Refer to 7.4 for numerical input.)
- 3 Press the **[O/T]** key. The set time will be stored.
- 4 Proceed to next time setting by the **[MENU]** key, or return by the **[POWER]** key.

Skipping Clock-CAL

If Clock-CAL starts while the balance is in use, press the **[POWER]** key to abort that cycle.

Turning Off Clock-CAL Function

When all three Clock-CAL times are set to “00:00”, the function is off.

10.3.4 PCAL: Calibration of the Built-in Weight (UW series only)

Not applicable to a verified balance as a legal measuring instrument in using region

PCAL is used to calibrate the built-in weight to a standard calibration weight that is correctly calibrated, traceable and/or certified. The PCAL procedure is password protected. The administrator should set this password (refer to 10.3.5).



Caution

Use an appropriately controlled, precise calibration weight for this procedure. If it is performed without an appropriate calibration weight, span calibration and calibration checks using the built-in weight may not be correct in subsequent operations.



(Example)



- 1** Unload the sample from the pan and verify a zero mass display.
- 2** Select the menu item **10**.
“PAS: 0000” is displayed.
- 3** Enter the PCAL password using the **[UNIT]** and **[PRINT]** keys, then press the **[O/T]** key.
The default password is 9999, set at shipment or upon menu reset.
After “PCAL 3” is displayed, the value of the standard weight to be loaded blinks.



Changing the Calibration Weight to be Used

Pressing the **[CAL]** key allows changes to the weight value. Modify the value using the **[UNIT]** key and **[PRINT]** key, then press the **[O/T]** key. Refer to 7.4 for how to make numerical input. To interrupt modification, press the **[POWER]** key. Calibration range with external weights is designated to each model. Refer to “3. Specifications” for calibration range. Attempt of inputting an invalid calibration weight value causes an error message.

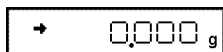
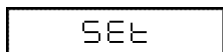

- 4** Load the standard weight displayed, and press the **[O/T]** key.
Soon, zero is displayed and blinks.
- 5** Unload the weight and press the **[O/T]** key.
The display proceeds to “PCAL 0”. When the mass display appears, calibration is complete.

**Notes**

- “SEt” is displayed during the process. Leave the balance in a stable state until the mass display appears as in step 5.
- In PCAL, the value of the “weight to be loaded” cannot be changed.
- Set the PCAL password using menu item **71**.

10.3.5 PCAL Password Setting (UW series only)

Not applicable to a verified balance as a legal measuring instrument in using region

This password is necessary to access the PCAL function.

It is recommended that the balance administrator set this password to prevent an unauthorized person from incorrectly calibrating the built-in calibration weight.

Select menu item **71**. The numerical setting display appears.

Enter a 4-digit number from “0000” to “9999”.

Refer to [7.4](#) for numerical input.

**Note**

When the menu is reset, the PCAL password is reset to “9999”.

10.4 For GLP/GMP/ISO Conformance

These settings should be made by the administrator.

10.4.1 Calibration Report Setting

Turns the calibration report function ON/OFF. Use this to generate and output a calibration report as for GLP, GMP or ISO9000. An electronic printer (optional accessory) is required to print the report.

To create calibration report, select menu item **68**.

To turn off calibration report function, select menu item **69**.



Note

Date output, ID number etc. of electronic printer EP-50 or EP-90 should be turned off when calibration report is produced.

10.4.2 Balance ID Setting

Individual balances can be identified by the serial number on the main body of the balance. The user can add a four-digit ID number to the calibration report.

Select menu item **70**. Set a 4-digit number from "0000" to "9999".

11. Environment

11.1 Overview

Settings on the balance can be changed to compensate for the installation environment such as the degree of vibration or air movement or for the purpose of weighing a solid, liquid or powder.

11.2 Stability and Response (Averaging)

It is possible to match the stability of the display and the degree of response with the requirements of specific applications or the installation environment. One of the five modes can be selected. Note that adjustments for stability and response conflict with each other, although the UW/UX series is designed to meet both.

Auto mode: Select menu item **22**.
The balance automatically performs optimum averaging dynamically while observing the load data. This is the recommended setting and should be used unless special circumstances exist.

**Pouring mode:
(Filling, dosing)** Select menu item **23**.
This mode is particularly suitable for dosing or filling purposes.
Note that this mode is very sensitive to wind and vibration.

(Environmental setting in Pouring mode)

Pouring mode allows further adjustments to the surrounding environmental conditions. Choose the optimal setting for your installation site observing the response and stability.

Every time the circle in the right part of the **[O/T]** key is pressed during weighing in Pouring mode, the environmental setting will be changed and cycles in the following order. Upon changing the setting, the new setting is briefly displayed as shown in “ ”.

normal environment (“norm E”) → unstable environment, (“UnStb E”)
→very stable environment, (“StAbL E”) → normal environment, (“norm E”).

During use, the current environmental setting of Pouring mode can be confirmed by observing the position of the ◀ symbol in the display.

(Display)

- ◀ When “UnStb E” is selected
- ◀◀ When “norm E” is selected
- ◀◀◀ When “StAbL E” is selected

**Note**

While “Pouring” is selected as the Stability and Response setting, taring the container or zeroing the display cannot be made by pressing the right-most part of [O/T] key. Press the center or the left part of [O/T] key for taring or zeroing.

- Standard mode:** Select menu item [24](#).
This mode is suitable for weighing in a normal environment. Averaging is fixed and does not change dynamically as in the Auto mode.
- Anti-vibration mode:** Select menu item [25](#).
Use this mode when the balance is used in a location where there are large vibrations and the display fluctuates in the Auto mode.
Response is deteriorated at small mass amount changes.
- Anti-wind mode:** Select menu item [26](#).
Use this mode when the balance is used in a location where it is exposed to airflow that causes the display to fluctuate in the Auto mode.
Response deteriorates further than the Anti-vibration mode, but weighing is comparatively stabilized.

**Note**

If weighing cannot be performed efficiently even with the Anti-wind mode, change the installation site of the balance or use the optional windbreak (large).

11.3 Stability Detection and Settings

Stability detection is an auxiliary function used for the following purposes.

- (1) When the weigh is stabilized during measurement, Stability mark is prompted as an auxiliary indication of measurement stability.
- (2) Operations such as data output and auto zeroing of the below listed functions are triggered by stability detection. Some data output functions operated with communication commands ([15.2.3](#)) are also linked to stability detection.
(Functions that employ stability detection)
Auto Print (See [13.3](#)), Auto Zero (See [13.4](#)), Taring/Printing at Stability (See [13.6](#)), Peak Hold (See [14.3](#)), Auto-Memory and Zeroing (See [14.5](#)), Animal Weighing (See [14.6](#)), Formulation Mode (See [14.7](#)).

It is possible to adjust the operation with the following stability detection settings.

(a) Stability Detection Band (11.3.1)

(b) Timing of Stability Mark Illumination and Automatic Output (11.3.2)

It is not usually required to change these settings as they are optimized at default. However, it is allowed to change according to 11.3.1 and 11.3.2 when: wishing to ease the criteria of stability detection under very unstable environmental or sample conditions, or wishing to accelerate automatic data output when using a function that employs stability detection.



Note

Stability mark is an auxiliary device to inform measurement stability. The displayed value may change while the stability symbol remains illuminated if the load is changing slowly, or depending on the stability detection settings.

11.3.1 Stability Detection Band

The default setting is “1 count” and the measurement is regarded to be stable when the display has remained within one display count for a fixed length of time. If stability detection band is set at “2 counts”, it will be regarded to be stable when the display has remained within two display counts. Selecting a larger stability detection band generally eases the criteria and makes stability mark illuminate more readily. However, it will be more likely for the display to further fluctuate after prompt of stability mark.

Try a larger stability detection band when data outputs triggered by stability detection is slow due to very unstable environmental and/or sample conditions.

Stability detection band	1 count (default setting)	2 counts	4 counts	8 counts	16 counts*	32 counts*	64 counts*
Menu item number	27	28	29	30	31	32	33

*Not applicable to a verified balance as a legal measuring instrument in using region.



Note

Use “16 counts” to “64 counts” for Auto Print, Animal Weighing or other data-outputting function under very unstable conditions only.

11.3.2 Timing of Stability Mark Illumination and Data Output

The prompt of stability mark and automatic data output of the functions employing stability detection take place at the same timing. The timing after detection of stability is optimized at the default and it is not necessary to change the setting usually.

However, adjustment of the timing is allowed to three levels according to specific measurement requirements. When wishing to accelerate automatic data output with functions such as animal weighing, select menu item **21a**. When wishing to delay the prompt of stability mark, select menu item **21c**. Select menu item **21b** to return it to the standard setting.

11.4 Tracking

Tracking is the function that will maintain the current displayed value as long as possible.

To turn ON this function, select menu item **34**.

To turn OFF this function, select menu item **35**.



Zero Tracking Function

When the display is zero, tracking functions as “zero tracking” to keep the zero display as long as possible. “Zero tracking” automatically cancels small zero drift.

It is recommended to set tracking off when measuring slight mass change such as in the process of drop addition or liquid evaporation.



Note

Using a verified balance as a legal measuring instrument in using region:

Even when Tracking is ON, the range where it works is restricted to the vicinity of the zero, and it is subjected to conditions, according to the regulations.

12. Units

12.1 Unit Display Set-up



Note

Using a verified balance as a legal measuring instrument in using region:

Only g (gramme=gram), ct (carat) weighing units, percentage conversion and piece counting are available for use. Carat is not available for UW820SV and UW8200SV models.

The UW/UX series balance can display weighed results in various weighing units (Refer to 5.2).

(Example)

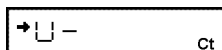

When menu item **58** (carat) has been selected.

- 1** It is possible to display units other than “g”. Press the **[UNIT]** key in mass display to sequentially change the selected units.
- 2** Before weighing, set the display units to be used. Gram, %, and PCS (piece counting) are set up before shipment. Set up the desired units by selecting menu from **54** to **62**. For details of PCS and specific gravity measurement, refer to 13.3 and 14.1 to 14.2.



Notes

For the unit names, refer to the menu map.

- In the unit setting menu, the stability symbol is prompted to indicate the currently set units.
- Set or release the unit by pressing the **[O/T]** key when the unit is displayed. Gram cannot be released.

User unit (menu item **62**): A numeric value (multiplier) is multiplied by the gram (g) weight of the unit.

Error Display

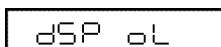

Display Overload: This display appears if the mass display exceeds 7 digits due to the choice of unit.

12.2 Percentage (%) Conversion

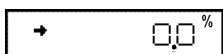

- 1 Set the % unit with menu item **56** if it is not set up.

The % unit is set before shipment.

- 2 Press the **[UNIT]** key several times in the mass display until the % unit is displayed.

Setting the 100% reference

- 1 Press the **[O/T]** key to tare the balance.

- 2 Load the reference sample that corresponds to the 100% value. This value must be equivalent to 100 counts or more in the “g” unit.

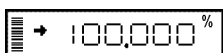

- 3 When the stability mark prompts, press the **[CAL]** key.

“SEt” is displayed briefly and the reference sample weight is displayed as 100%.

The weights of subsequent samples are displayed as a percentage of the reference sample weight.



Note

The numbers of digits displayed in the % unit and rounding off of the minimum digit vary depending on the mass value of the reference sample and the balance model. It is not possible to obtain resolution greater than that in the “g” unit.

13. Enhancing Productivity

Functions that are useful mainly in production sites are described in this chapter.

Only one of the functions in the menu group 4 (Refer to 7.3) (41 to 53) can be used at a time. When one of the functions in menu group 4 is to be used with a weighing unit other than gram, select the function from the gram-display first. Then, change to the other unit with the **[UNIT]** key. To release this function, use the **[POWER]** key. For returning to the previous function, Last Menu Recall function is convenient. There are some other combinations of functions that can be used together. Some functions employ the value set in Zero Range setting (refer to 13.5).

13.1 Checkweighing and Target Display

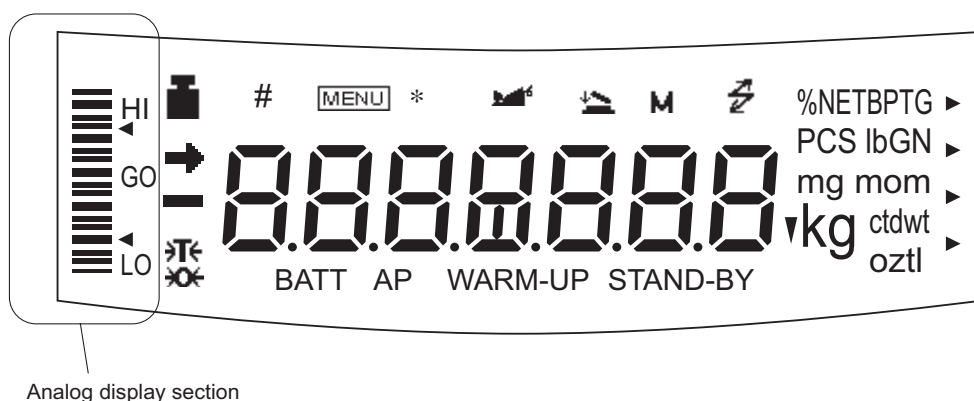

The UW/UX series balance has an analog bar graph located on the left side of the display. This graph can be conveniently used for checkweighing or cumulative weighing.

The graphic display functions include the two display modes of checkweighing, the target mode, and full scale mode. Only one of them can be used at a time. Refer to 9.1 for the full scale mode and the no bar graph display.

Upon selection of either the checkweighing mode or the target mode, the numerical value for threshold or target is requested. Numeric values are memorized independently for each graphic display mode.

When one of the checkweighing modes is selected, a signal corresponding to HI, GO, or LO in the graphic display can be transmitted via the RS-232C/AUX connector.

Target, limit, upper, and lower values are set as numeric values only. Set the correct numerical value for the unit that will be used for weighing.

- In weighing mode, changing the displayed unit does NOT change the target, limit, upper, or lower numeric values. For example, when the upper limit has been set at 10g, switching the unit from “g” to “kg” does not change the limit to 10kg. It will be 0.01kg.

The decimal point is invisible in the value setting display. Determine its position based on the resolution of the balance. For example, if the balance’s minimum display is 0.01g, 150g must be set by inputting “15000” in the display.

13.1.1 Checkweighing (Comparator) Display Type 1

This is the best mode to determine pass or failure judgment based on the sample weight.

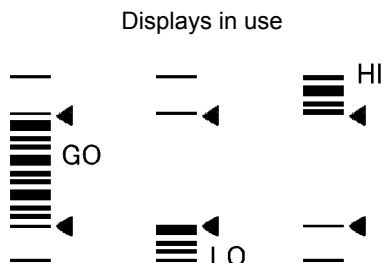

- 1** Select menu map item **15**.
- 2** Set the upper threshold value, which corresponds to the upper triangle mark, with menu item **16**.
- 3** Set the lower threshold value, which corresponds to the lower triangle mark, with menu item **17**.



Note

The decimal point is invisible in each value setting display. Setting the value cannot be made in gram unit. Determine the number based on the minimum display of the balance. For example, if the balance's minimum display is 0.01g, 150g (150.00g in this balance) must be set by inputting "15000" in the display, not "150" or "150.00".



Note

Determination as follows:

Upper threshold < Sample weight	HI
Lower threshold ≤ Sample weight ≤ Upper threshold	GO
Sample weight < Lower threshold	LO

13.1.2 Checkweighing (Comparator) Display Type 2

Use this mode for classification based on the sample weight. The display looks like a bar graph, but also includes a checkweighing function.

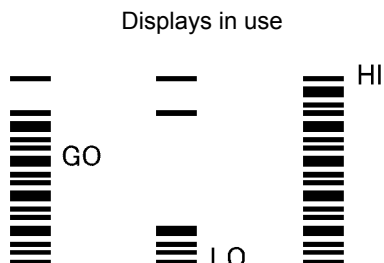

- 1** Select menu map item **18**.
- 2** Set the upper threshold value, which corresponds to the upper triangle mark, with menu item **19**.
- 3** Set the lower threshold value, which corresponds to the lower triangle mark, with menu item **20**.

Upper threshold < Sample weight	HI
Lower threshold ≤ Sample weight ≤ Upper threshold	GO
Sample weight < Lower threshold	LO

**Note**

The decimal point is invisible in each value setting display. Setting the value cannot be made in gram unit. Determine the number based on the minimum display of the balance. For example, if the balance's minimum display is 0.01g, 150g (150.00g in this balance) must be set by inputting "15000" in the display, not "150" or "150.00".

13.1.3 Target Mode

This mode is useful for constant amount weighing of liquid or judgment of excess and shortage. The target value is the numeric value that is the desired amount in the unit that is used for weighing. The limit value is the numeric amount above or below the target value that is acceptable. The target will be indicated as the center line in the analog display. The limits will be indicated as triangle marks. A moving bar represents the current weight on the pan.

Display examples in use

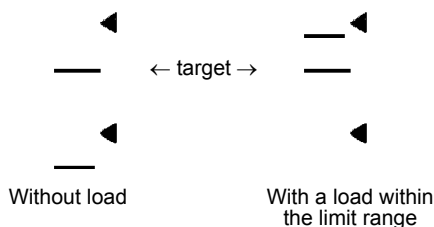

- 1 Select the Target mode with menu item **12**.
- 2 Set the "target" value, which corresponds to the center line of the graphic display, with menu item **13**.
- 3 Set the "limit" value, which corresponds to the distance between the center line and upper or lower triangle marks, with menu item **14**.

**Note**

The decimal point is invisible in each value setting display. Setting the value cannot be made in gram unit. Determine the number based on the minimum display of the balance. For example, if the balance's minimum display is 0.01g, 150g (150.00g in this balance) must be set by inputting "15000" in the display, not "150" or "150.00".

13.2 Piece Counting (PCS)

1 Set up the PCS with menu item **57** if it is not set.

(The PCS unit is set before shipment.)

2 Press the **[UNIT]** key several times in the mass display until the PCS is displayed.

3 Load the container and press the **[O/T]** key to tare the balance.

4 Count exactly five pieces (or 10, 20, 50, 100, or 200 pieces) of sample to be measured and load them on the pan.

5 Press the **[CAL]** key.

6 Every time the **[CAL]** key is pressed, the display sequentially changes as

“Ld 5pcs” ... “Ld 200pcs”, “Ld 5pcs”...

The default setting is “Ld 10pcs”.

Press the **[O/T]** key when the display is equivalent to the number of loaded pieces.

Example: If 50 pieces are loaded, press the **[O/T]** key when “Ld 50pcs” is displayed. This determines the unit weight or average weight per piece.

As sample is added or removed, the piece count (number of pieces) is displayed.

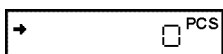

(Example)

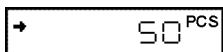
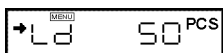

Note

Repeat steps 3 through 6 above when the sample or manufacturing lot is changed.



Piece Count Menu Display at Next Setting

In this example, when the **[CAL]** key is pressed in the next PCS menu, display starts from “Ld 50pcs”.

13.3 Auto Print

Auto Print function allows output of the data automatically without pressing the **[PRINT]** key for each sample. The “Auto-Print symbol is illuminated when the Auto Print function is activated.

Six types of Auto Print are selectable.

Print on loading: Select menu item **42**.

Load the sample when the value displayed is within the Zero Range. When stability is detected and the positive displayed value is more than 5 times the Zero Range, data is automatically output.

The next data output is not performed unless the display has returned to a value within the Zero Range by unloading the sample or pressing the **[O/T]** key.

Print on loading and unloading: Select menu item **43**.

Load or unload the sample when the displayed value is within the Zero Range. When stability is detected and the displayed positive or negative value is more than 5 times the Zero Range, data is automatically output.

The next data output is not performed unless the display has returned to a value within the Zero Range by unloading the sample or pressing the **[O/T]** key.

Print on loading and on zero: Select menu item **44**.

Load the sample when the value displayed is within the Zero Range. When stability is detected and the positive displayed value is more than 5 times the Zero Range, data is automatically output.

Unload the sample or press the **[O/T]** key. When the displayed value is within the Zero Range and stability is detected, data is output again.

Print on loading, unloading, and on zero: Select menu item **45**.

Load the sample when the value displayed is within the Zero Range. When stability is detected and the displayed positive or negative value is more than 5 times the Zero Range, data is automatically output.

Unload the sample or press the **[O/T]** key. When the displayed value is within the Zero Range and stability is detected, data is output again.

Print continuously: Select menu item **46**.

Not applicable to a verified balance as a legal measuring instrument in using region

By pressing the **[PRINT]** key while the Auto-Print symbol and Stand-by symbol are lit, the Stand-by symbol goes out, the Communication symbol lights and the displayed data is continuously output.

Continuous output stops temporarily when the **[PRINT]** key is pressed.

**Note**

- During continuous output, the Communication symbol may appear to remain lit. If the transfer speed of the data output is slow, the display may become unstable. Increase the transfer speed as much as possible and set the handshake off (menu item **73**).
- Stability information is added to outputting data of a verified balance as a legal measuring instrument in the EU.
See [15.2.2](#) (1), (2)-(i) and (2)-(ii)

Print on “GO” judge of checkweighing: Select menu item **47**.

When the checkweighing function (See [13.1](#)) is used and stability is detected in the “GO” range, the data is output once.

The next data output is executed after the displayed value is within the Zero Range.

**Notes**

- See [13.5](#) for details of Zero Range.
- See [11.3](#) for details of stability detection.
- Pretaring Value ([13.7](#)) function cannot be used with Auto Print functions.
- Auto Print mode setting can be cleared without menu operation, by pressing the **[POWER]** key for about three seconds.
- Not more than one of these seven functions can be set at a time. Setting the second one with the menu will automatically clear the previously set function; Auto Print([13.3](#)), Auto Zero([13.4](#)), Peak Hold([14.3](#)), Interval Timer([14.4](#)), Add-on mode([14.5](#)), Animal Weighing mode([14.6](#)), Formulation mode([14.7](#)).
- For automatic outputs at preset intervals, see “[14.4 Interval Timer](#)”.
- When minimum display has been switched to 10d (See [9.2](#)), the optimized Zero Range for 1d display may cause failure in the operation (e.g. Data is not automatically output as sample is loaded). Select optimal Zero Range value again when minimum display has been changed (See [13.5](#) for details).

13.4 Auto Zero

Not applicable to a verified balance as a legal measuring instrument in using region

When the displayed value is within the Zero Range and stability is detected, zeroing occurs automatically. The Zero symbol appears in the display when the Auto Zero function is active. Other keys function as expected with the Auto Zero function activated.

Select menu item **41** to activate it.



Notes

- See [13.5](#) for details of Zero Range.
- See [11.3](#) for details of stability detection.
- Pretaring Value ([13.7](#)) function cannot be used with Auto Zero function.
- Auto Zero setting can be cleared without menu operation, by pressing the **[POWER]** key for about three seconds.
- Not more than one of these seven functions can be set at a time. Setting the second one with the menu will automatically clear the previously set function; Auto Print([13.3](#)), Auto Zero([13.4](#)), Peak Hold([14.3](#)), Interval Timer([14.4](#)), Add-on mode([14.5](#)), Animal Weighing mode([14.6](#)), Formulation mode([14.7](#)).
- When minimum display has been switched to 10d (See [9.2](#)), the optimized Zero Range for 1d display may cause failure in the operation. Select optimal Zero Range value again when minimum display has been changed (See [13.5](#) for details).

13.5 Zero Range

The “Zero Range” value is used in the following functions as a reference for judging whether the sample is loaded: Auto Print (13.3), Auto Zero(13.4), Peak Hold(14.3), Add-on Mode(14.5), Animal Weighing Mode(14.6), and Formulation Mode(14.7).

If the display is within the Zero Range, the balance determines that the balance is not loaded. If the display reaches five times the Zero Range or more, it determines that a sample is loaded. Functions which involves judgment of whether a sample is loaded or not work in accordance with the Zero Range setting.

Example: Samples are weighed one after another with UX2200H (minimum display 0.01g) and each measurement result is automatically output with the Auto Print “on Ld” function (13.3).

Suppose Zero Range is set to 10. As 1 count for UX2200H is 0.01g, Zero Range is 0.10g in this case. When a sample of 0.50g or more is placed, it is judged to be loaded and the data will be output. When this sample is removed and the display returns below 0.10g, it is judged that the balance is unloaded, then it is ready for the next sample. If it does not return below 0.10g, the previous sample is not judged to be unloaded. Therefore, even when the displayed value reaches 0.50g again by next loading, the data will not be automatically output. Select Zero Range value according to the influences of environment (causing difficulty in zero-return), the weight of the samples, etc. so that Auto Print functions properly.

Set the “Zero Range” value with menu item **48** using the number of counts displayed in gram-display. The setting range is 01 to 99 with 10 being the default value. Even when weighing will be done in another unit, Zero Range setting is made by only gram value.



Notes

- Zero Range value is a common setting for all the Zero Range-linked functions.
- The application of Zero Range value is different depending on each function. Refer to the section of each function using Zero Range.
- When a Pretare value is set, the thresholds to determine that there is “no load” becomes “– Pretare ± Zero Range”.
- When minimum display is changed to 10d (See 9.2), number of counts used for load/unload judgment is counted based on the 10d minimum display. Therefore, the Zero Range value optimized for 1d display can be too large for 10d display. This may cause failure of linked operation, e.g. automatic output upon loading. Optimize Zero Range value again when switching minimum display 1d/10d.

13.6 Taring/Printing at Stability

Not applicable to a verified balance as a legal measuring instrument in using region

Determine if the balance should wait for stability before printing when the **[PRINT]** key is pressed or zeroing when the **[O/T]** key is pressed.

To print or tare without waiting for stability: (Immediately operating mode)

Select menu item **39**.

To have printing or taring take place after stability is detected: (Waiting for stability detection)

Select menu item **40**.



Notes

- While the balance is waiting for stabilization, ---- is displayed.
- When the **[O/T]** key has been pressed, “---” is displayed. At this occasion, press the **[POWER]** key if you desire to disable this function and abort taring.
- When the **[PRINT]** key has been pressed, Once the communication symbol and the Stand-by symbol are lit, then stability detection is waited. The data will be output after stability is detected. If the **[POWER]** key is pressed during the waiting, the balance is brought to stand-by. The data will be printed upon stability in the next weighing.
- See [13.5](#) for details of Zero Range.
- See [11.3](#) for details of stability detection.

13.7 Pretaring Value

Not applicable to a verified balance as a legal measuring instrument in using region



Notes

- If the weight of the tare (container) varies, accurate measurement with Pretaring Value function cannot be made.
- Pretaring Value function cannot be used with Peak Hold (14.3), Add-on Mode(14.5), Animal Weighing Mode(14.6), Formulation Mode (14.7) or Auto Print function (13.3).

This function is used to weigh the mass of a sample packed in a container such as a bottle or bag without opening the container. Pretare function should be used only if the mass of each container does not vary from sample to sample. Instead of zero, the pretare value is displayed (as a negative value) when the **[O/T]** key is pressed. The pretare value is then subtracted from the total load on the balance pan to display the weight of the sample.

1 Select menu item **36**.

2 Set the Pretare value. Refer to 7.4 for numerical value input.



Pretare Value

Cancel the Pretare value by setting the value to zero.

When a Pretare value other than zero has been set, the Tare symbol illuminates.

The Pretare value is set using the “g” unit. The maximum value is the weighing capacity of the balance.

Check the Pretare value by pressing and holding the **[O/T]** key for approximately 3 seconds during weighing.

Use the AKB-301 external keypad if you have to change the Pretare value frequently.

14. Application Functions

Application measurement functions are described in this chapter.

Only one of the functions in the menu group 4 (Refer to 7.3) (41 to 53) can be used at a time. When one of the functions in menu group 4 is to be used with a weighing unit other than gram, select the function from the gram-display first. Then, change to the other unit with the **[UNIT]** key. To release this function, use the **[POWER]** key. For returning to the previous function, Last Menu Recall function is convenient. There are some other combinations of functions that can be used together. Some functions employ the value set in Zero Range setting (refer to 13.5).

14.1 Solid Specific Gravity Measurement

Solid specific gravity measurement refers to the measurement of the sample (solid) weight in the air and in a liquid of known specific gravity (or density) and the calculation of the sample specific gravity (or density).

The ▼d symbol is used to represent the solid specific gravity in this balance. The data output unit is DS.



Note

Use of the optional **SMK-101, or SMK-102 Specific Gravity Measurement Kit** (refer to A-3.) is recommended for efficient measurements. When using the SMK-101 or SMK-102, refer to the instruction manual of the kit. Follow the instruction below when a hanging pan and a tank are prepared by the user.

- 1 Select menu item **60-1**, **60-2** in advance.
 - 60-1** : Select either the hold display mode or the continuous display mode for the specific gravity value display. Press the **[CAL]** key repeatedly until [SG Hold] appears.
 - Each time the **[O/T]** key is pressed the “→” symbol on the left side of the display turns on or turns off. The display is configured as shown below according to the on/off state of “→”.
 - on : Hold display mode

➔ off : Continuous display mode (the specific gravity value is updated according to the change of weight in water)

Press the **[POWER]** key repeatedly to return to the mass display.

60-2 : Enter the value of the medium liquid density (or specific gravity (g/cm^3)) (water, alcohol etc.) in which the sample is immersed. Refer to 7.4 for numerical value input. To cancel the set-up, set the value to zero.

2 Remove the below-weigh hook cap from the bottom of the balance to expose the below-weigh hook.

3 Hook the hanging pan, and then immerse the hanging pan in the tank filled with the liquid of known specific gravity (or density).

4 When the **[UNIT]** key is pressed a number of times from the mass display, [Air▼gd] appears for about two seconds. Afterward, the display switches to the [▼gd▶] display. This is the weight measurement in air mode. During weight measurement in air, “▶” turns on in the upper-right of the display.

5 Press the **[O/T]** key.

6 Place the items to be measured on the pan.

7 When the stability mark appears, press the **[CAL]** key. This measures the weight of the item being measured in air.

8 The display shows [wAtr▼gd] for about two seconds. Afterward, the display switches to the [▼gd▶] display. This is the weight measurement in water mode. During weight measurement in water, “▶” turns on in the lower-right of the display.

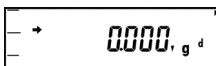
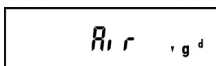
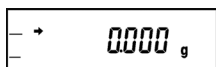

(Example)

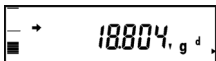

(Example) 

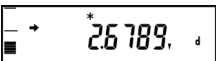
(Example) 

(Hold display mode example)

9 Place the items to be measured on the immersed hanging pan. The display shows the weight value in water. Press the **[CAL]** key to show the specific gravity value in the set specific gravity value display mode.

Press the **[POWER]** key to return to 8. If air bubbles adhered to the item being measured and the result is a specific gravity value that differs from the expected value, you can recalculate the specific gravity value by retrying the weight measurement in water after removing the air bubbles from the item.

10 To make the next measurement, unload the pans, press **[CAL]**, and begin again at Step 5. When finished measuring specific gravity, press the **[UNIT]** key..



Notes

- Up to four decimal places are displayed for density or specific gravity. Depending on the measurement conditions, not all digits are stable even the balance is working normally.
When it is not possible to stabilize the display in all 4 decimal places, you may change the minimum display by using the **[UNIT]** key.
How to change the minimum display in density (specific gravity) display
When the result is displayed, press and keep holding down the **[UNIT]** key for about three seconds.
This changes the minimum display to 10d (d: original minimum display). Every time the same key operation is made, the minimum display changes and cycles in the order of "1d → 10d → 100d → 1000d → 1d →".
- When loading the sample on the pan in the liquid, ensure that the entire sample is immersed in the liquid.
- The balance does not re-zero when the **[O/T]** key is pressed in this function.
- The dimensions of the below-weigh hook are shown in A-7.

14.2 Liquid Density Measurement

Liquid density measurement refers to the measurement of the weight of a reference solid of a known volume in air and in the sample liquid. Density of the liquid is calculated from these two values.

The display unit for liquid density is “d”. The data output unit is DL.



Note

Use of the optional **SMK-101, or SMK-102 Specific Gravity Measurement Kit** (refer to [A-3](#).) is recommended for efficient measurements. When using the SMK-101 or SMK-102, refer to the instruction manual of the kit. Follow the instruction below when a hanging pan and a tank are prepared by the user.

- 1** Select menu item **61-1**, **61-2** in advance.

61-1 : Select either the hold display mode or the continuous display mode for the specific gravity value display. Press the **[CAL]** key repeatedly until **[SG Hold]** appears.

Each time the **[O/T]** key is pressed the “➔” symbol on the left side of the display turns on or turns off. The display is configured as shown below according to the on/off state of “➔”.

 - ➔ on : Hold display mode
 - ➔ off : Continuous display mode (the specific gravity value is updated according to the change of weight in water)

Press the **[POWER]** key repeatedly to return to the mass display.

61-2 : Enter the value for the volume (cm³) of the reference weight. Refer to [7.4](#) for numerical value input. To cancel the set-up, set the value to zero.
- 2** Remove the below-weigh hook cap from the bottom of the balance to expose the below-weigh hook.
- 3** Hook the hanging pan, and then immerse the hanging pan in a tank containing the sample liquid.

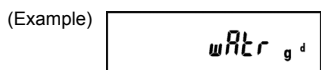
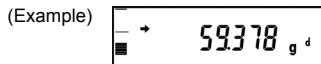
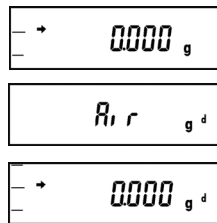

4 When the **[UNIT]** key is pressed a number of times from the mass display, [Airgd] appears for about two seconds. Afterward, the display switches to the [gd ▶] display. This is the sinker weight measurement in air mode. During weight measurements in air, “▶” turns on in the upper-right of the display.

5 Press the **[O/T]** key.

6 Place the sinker on the balance pan.

7 When the stability mark appears, press the **[CAL]** key. This measures the weight of the sinker in air.

8 [wAtr gd] appears for about two seconds. Afterward, the display switches to the [gd ▶] display. This is the sinker weight measurements in liquid, “▶” turns on in the lower-right of the display.

9 Place the sinker in the immersed hanging pan. The display shows the weight value in liquid. Press the **[CAL]** key to show the liquid density in the set specific gravity value display mode. Press the **[POWER]** key to return to 8. If air bubbles adhered to the sinker and the result is a density that differs from the expected value, you can recalculate the density by retrying the weight measurement in liquid.

10 To make the next measurement, unload the pans, press **[CAL]**, and begin again at Step 5.



Notes

- Up to four decimal places are displayed for density or specific gravity. Depending on the measurement conditions, not all digits are stable even the balance is working normally.

When it is not possible to stabilize the display in all 4 decimal places, you may change the minimum display by using the **[UNIT]** key.

How to change the minimum display in density (specific gravity) display

When the result is displayed, press and keep holding down the **[UNIT]** key for about three seconds.

This changes the minimum display to 10d (d: original minimum display).

Every time the same key operation is made, the minimum display changes and cycles in the order of "1d → 10d → 100d → 1000d → 1d →".

- When loading the reference weight on the pan in the liquid, ensure that the entire weight is immersed in the liquid.
- The dimensions of the below-weigh hook are shown in A-7.

14.3 Peak Hold

Not applicable to a verified balance as a legal measuring instrument in using region

Detects the peak value of a fluctuating weight. "Peak value" is the highest or lowest value displayed in the duration after it has changed beyond five times the Zero Range until the first stability detection after that. The "P" symbol ("P" of Auto-Print symbol) is illuminated when the Peak Hold function is activated. Select menu item **49** in advance.

- 1** In the peak detection standby state with the "P" symbol and the Stand-by symbols illuminated, press the **[O/T]** key to tare the display.
- 2** Press the **[PRINT]** key.
The Stand-by symbol disappears and peak value detection starts.
- 3** Upon stability is detected, the operation of peak value detection is ceased.
The detected peak value is displayed with the "P" symbol and Asterisk simultaneously illuminated. The peak value is output to external devices if connected. After the detection of the peak value, the same display remains regardless of the load change on the pan.
- 4** Press the **[POWER]** key for the next operation.
The balance returns to the peak detection standby state described in the above step **1**.



Notes

- Press the **[POWER]** key in the peak detection standby state to initiate the power standby state.
- Press the **[POWER]** key during detection of the peak to return to the peak detection standby state.
- Peak Hold setting can be cleared without menu operation, by pressing the **[POWER]** key for about three seconds.
- Polarity of the peak value displayed is “polarity of the displayed value of the first change (by five times or more of Zero Range) from the display within Zero Range.”
- Usually the peak value is easily measured by selecting menu item **23** (Pouring mode). Depending on the weighting conditions and the sample type, this setting may not always be suitable.
- Pretaring Value (13.7) function cannot be used with Peak Hold function.
- See 13.5 for details of Zero Range.
- See 11.3 for details of stability detection.
- Not more than one of these seven functions can be set at a time. Setting the second one with the menu will automatically clear the previously set function; Auto Print(13.3), Auto Zero(13.4), Peak Hold(14.3), Interval Timer(14.4), Add-on mode(14.5), Animal Weighing mode(14.6), Formulation mode(14.7).
- When minimum display has been switched to 10d (See 9.2), the optimized Zero Range for 1d display may cause failure in the operation. Select optimal Zero Range value again when minimum display has been changed (See 13.5 for details).

14.4 Interval Timer

Not applicable to a verified balance as a legal measuring instrument in using region

Automatically outputs the displayed value at preset intervals. The “T” symbol (“T” of the Tare symbol) is illuminated when the Interval Timer is activated.

The optional AKB-301 Application Keyboard is convenient when the interval is changed frequently.

- 1** Select menu item **[50]** and set the output interval (00:01 = 1 sec to 99:59 = 99 minutes 59 seconds).
- 2** In the interval timer standby state when the “T” and the Stand-by symbols are both illuminated, press the **[PRINT]** key.
The first data is output. Data will be automatically output at the set time intervals thereafter.
- 3** To stop output, press the **[POWER]** key.
The balance returns to the interval timer standby state in step 1).



Notes

- Use the **[O/T]** key to erase the tare or zero the balance at any time.
- Pressing the **[POWER]** key in the interval timer standby state brings the power supply standby state.
- Interval Timer setting can be cleared without menu operation, by pressing the **[POWER]** key for about three seconds. This does not clear the set time interval value.
- Using the interval timer function to record data over a long period may cause data error due to balance drift.
- Some instruments receiving the data may not operate normally if the set time interval is short. To correct this, set the time interval to a longer period. When the set time interval is short and the instrument connected to DATA I/O is unknown, it is recommended to set the handshake to a setting other than “H-tm” **[76]**.
- Not more than one of these seven functions can be set at a time. Setting the second one with the menu will automatically clear the previously set function; Auto Print(13.3), Auto Zero(13.4), Peak Hold(14.3), Interval Timer(14.4), Add-on mode(14.5), Animal Weighing mode(14.6), Formulation mode(14.7).

14.5 Add-on Mode

This function is convenient for weighing a large number of sample components as they are added on the balance. Every time a component is added and stability is detected, the mass of it is displayed and output through RS-232C or DATA I/O interface. The display will then be automatically zeroed for the next component. When all the components have been weighed, the total mass is calculated by pressing **[POWER]** key.

Select menu item **52**.

- 1** Load the weighing vessel and press the **[O/T]** key in the Add-on standby state (The “Add-on” and the Standby symbols are lit).
Zeroing occurs.
- 2** Press the **[PRINT]** key.
The Stand-by symbol disappears, and Add-on measurement starts.
- 3** Load the first sample.
When stability is detected with a displayed value five times the Zero Range or more, the displayed value is automatically output and zeroing occurs. Even if the displayed value is less than five times the Zero Range, pressing **[PRINT]** key at stability causes the same effect.
- 4** Repeat the above step **3** until all the components have been weighed.
- 5** Press the **[POWER]** key.
The total sample mass on the pan is displayed and the balance returns to the Add-on standby state.
Press the **[PRINT]** key to output the total mass.
Start the next set of measurements from the above step **1**.



Notes

- In Add-on Mode, when stability is detected and the displayed value is within Zero Range, zeroing occurs automatically to maintain the zero display.
- When the **[POWER]** key is pressed in the Add-on standby state, the power standby state is initiated.
- Add-on Mode setting can be cleared without menu operation, by pressing the **[POWER]** key for about three seconds.
- Pretaring Value (13.7) function cannot be used with Add-on Mode.
- See 13.5 for details of Zero Range.
- See 11.3 for details of stability detection.
- Weighing unit (12.1) and minimum display (9.2) cannot be changed when Add-on Mode is on.
- When Add-on Mode is ON, fully-automatic span calibration by PSC (10.3.2) or Clock-CAL (10.3.3) is not performed. Weight symbol keeps blinking when span calibration is necessary. Span calibration with the built-in calibration weight or external weights can be performed between sets of measurements (Add-on standby).
- Not more than one of these seven functions can be set at a time. Setting the second one with the menu will automatically clear the previously set function; Auto Print(13.3), Auto Zero(13.4), Peak Hold(14.3), Interval Timer(14.4), Add-on mode(14.5), Animal Weighing mode(14.6), Formulation mode(14.7).

14.6 Animal Weighing

Not applicable to a verified balance as a legal measuring instrument in using region

Designed for weighing live animals. Select menu item **53** to activate Animal Weighing mode. Also, optimize the operational condition (See the following), “Stability Detection Band (11.3.1)” and “Timing of Stability Mark Illumination and Data Output (11.3.2)” depending on the size and movement of the weighed animal.

If you weigh rats or mice, refer to the below table showing the typical settings to obtain optimal accuracy and efficiency.

Recommended Settings for Rat and Mouse

Animal	Operational condition (See below)	Stability detection band (See 11.3.1 for details)	Timing of Stability Mark Illumination and Data Output (See 11.3.2 for details)
Rat	Cond3	4 counts (menu item 29)	“ES-FAst” (menu item 21a)
Mouse	Cond1 or 2	1 count (menu item 27 = default setting)	“ES-FAst” (menu item 21a)

Operational condition selection according to the level of animal’s movement.

Depending on the level of animal’s movement, operational condition (response and stability) can be optimized within Animal Weighing mode. At zero display in Animal Weighing mode, operational conditions can be switched using only the **[UNIT]** key. Select the optimal operational condition by observing the response and stability of measurement.

(Operational Conditions)

Operational condition	Level of animal’s movement	Remarks
Cond 1	Calm	
Cond 2	Moderate	Not suitable for weighing animal lighter than 50g.
Cond 3	Active	Not suitable for weighing animal lighter than 100g.

Cond 2 and Cond 3 are not suitable for weighing animals lighter than the respectively specified in the above. When lighter animals are weighed with these settings, the zero return after removing the animal may be very slow

(Switching operational conditions)

Every time the **[UNIT]** key is pressed at the zero display in Animal Weighing mode, the operational condition will be changed in the following order: [Cond 1] → [Cond 2] → [Cond 3] → [Cond 1].

Upon **[UNIT]** key is pressed, the new operational condition is briefly displayed. Thereafter, the confirmation of the operational condition setting can be made observing the position of the ◀ symbol in the right end of the display.

(Operational condition setting check display)

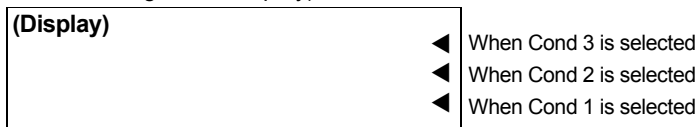

(Operation)

The Animal symbol is illuminated when this mode is active. Also a triangular symbol to indicate the currently set operational condition is illuminated in the right end of the display (See the above).

- 1** Load the weighing vessel and press the **[O/T]** key to zero the display.
- 2** Load the sample (animal) with a mass more than 50 times the Zero Range.
- 3** When the measurement reaches stability criteria of Animal Weighing, the weighed value is automatically output.
- 4** Unload the animal or press the **[O/T]** key.
- 5** When the mass display becomes less than 10 times the Zero Range and stability is detected, automatic zeroing occurs.
The mass of any residue remaining on the balance (excrement or fur) is canceled and returns to zero display.
Start weighing from the above step **2** for the next animal.



Notes

- On the premise of weighing animated objects, the stability detection band is automatically extended in the Animal Weighing mode. Reproducibility of the measurement data is slightly less than with other modes. If a larger stability detection band is selected with the menu (See [11.3.1](#)), stability detection is more readily made and the output of measurement result usually becomes faster. However, the accuracy may become poorer. When changing stability detection band, select according to the specific measurement's requirements on accuracy, observing the reproducibility on the test run.
- If the balance is slow to automatically return to the zero display, set a larger Zero Range value.
- Weighing unit cannot be changed when Animal Weighing is on.
- See [13.5](#) for details of Zero Range.
- See [11.3](#) for details of stability detection.
- When Menu Lock ([7.5.3](#)) is activated, operational condition of Animal Weighing is also locked.
- When Menu reset ([7.5.2](#)) is performed, operational condition setting of Animal Weighing is also returned to the default (Cond 1).
- Pretaring Value ([13.7](#)) function cannot be used with Animal Weighing mode.
- Small animal bucket set (option, see [A-3](#).) is recommended for weighing small animals such as mice
- When the **[POWER]** key is pressed in the Animal Weighing standby state, the power standby state is initiated.
- Animal Weighing mode setting can be cleared without menu operation, by pressing the **[POWER]** key for about three seconds.
- Not more than one of these seven functions can be set at a time. Setting the second one with the menu will automatically clear the previously set function; Auto Print([13.3](#)), Auto Zero([13.4](#)), Peak Hold([14.3](#)), Interval Timer([14.4](#)), Add-on mode([14.5](#)), Animal Weighing mode([14.6](#)), Formulation mode([14.7](#)).
- When minimum display has been switched to 10d (See [9.2](#)), the optimized Zero Range for 1d display may cause failure in the operation (e.g. Data is not automatically output as animal is placed). Select optimal Zero Range value again when minimum display has been changed (See [13.5](#) for details).

14.7 Formulation Mode

This function is convenient for weighing in the components of a formulation. The mass of each component is displayed and stored. Every time a component is added and **[PRINT]** key is pressed, the mass of that component is output through RS-232C or DATA I/O interface and the display will be automatically zeroed. When all the components have been weighed, the masses are summed up and the total mass is displayed and output by pressing **[POWER]** key.

Select menu item **51**.

(Operation)

1 When Formulation Mode is ON, the display stands at Formulation stand-by status upon entering the mass display. Add-on symbol, Memory symbol and Stand-by symbol are illuminated in the display.

Place a container (if used) and press **[O/T]** key to tare the display.

Note that taring with **[O/T]** key is not accepted after **[PRINT]** key is pressed in the following step **2** until **[POWER]** key is pressed in the step **5**.

2 Press **[PRINT]** key. When external device is connected, "----- FORMULATION MODE -----" will be output.

3 Load the first component and press **[PRINT]** key. Upon stability is detected at a value higher than five times Zero Range, the mass value will be output with a numbering "CMP001 =". The display will be automatically zeroed after that.

4 Repeat step **3** until all the components have been weighed.

5 Press **[POWER]** key.
The total mass will be displayed and output to external devices with a remark "TOTAL =".

6 Clear the pan.
Start the next set of measurements from the step **1**.

Output example: 1st component is 0.5361g,
2nd is 0.5422g, 3rd is 0.4488g.

---Formulation Mode---	
CMP001 =	0.5361g
CMP002 =	0.5422g
CMP003 =	0.4488g
TOTAL =	1.5271g



Notes

- Set the Stability and Response to Pouring mode (menu item **23** , See [11.2](#)) if faster response is required.
- When the **[POWER]** key is pressed in the Formulation standby state, the power standby state is initiated.
- Formulation Mode setting can be cleared without menu operation, by pressing the **[POWER]** key for about three seconds.
- See [11.3](#) for details of stability detection.
- See [13.5](#) for details of Zero Range.
- Cannot be used together with Pretaring ([13.7](#)).
- Weighing unit ([12.1](#)) and minimum display ([9.2](#)) cannot be changed when Formulation Mode is on.
- When Formulation mode is ON, fully-automatic span calibration by PSC ([10.3.2](#)) or Clock-CAL ([10.3.3](#)) is not performed. Weight symbol keeps blinking when span calibration is necessary. Span calibration with the built-in calibration weight or external weights can be performed between sets of measurements (Formulation stand-by).
- Not more than one of these seven functions can be set at a time. Setting the second one with the menu will automatically clear the previously set function; Auto Print([13.3](#)), Auto Zero([13.4](#)), Peak Hold([14.3](#)), Interval Timer([14.4](#)), Add-on mode([14.5](#)), Animal Weighing mode([14.6](#)), Formulation mode([14.7](#)).

15. Connecting Peripheral Instruments

(For WindowsDirect, refer to “6. WindowsDirect Function”)

A variety of peripheral instruments are available for use with the UW/UX series balance, such as an electronic printer, keyboard or personal computer.

This chapter describes how to connect and communicate with peripheral instruments.

The details of the balance's communication settings are described in 15.3.

15.1 Electronic Printer

Shimadzu Electronic Printer EP-80, EP-60A can be connected.

- 1 For the balance, select the default communication settings..

Menu item number	76	77	83	89	92	94
Setting	Handshaking, Timer	Format, EB type	Baud Rate, 1200 bps	Parity, None	Stop bit, 1 bit	Delimiter, CR

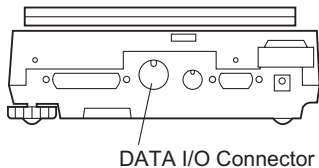

- 2 Disconnect the power to the balance and the electronic printer.
- 3 Connect the DATA I/O connector of the balance to the electronic printer using the attached cable of the printer.
- 4 First turn ON the power to the balance, then turn ON the power to the electronic printer.



Notes

- Read the instruction manual of the electronic printer.
- When using EP-80 simultaneously with WindowsDirect function, communication settings are different. Follow 6.2.1 for setting the balance.
- **Date and time output:** Press and hold the balance's [PRINT] key for about 3 seconds

15.2 Personal Computer - RS-232C -

15.2.1 Connecting the Cable



Notes

- The cable must have the correct connections as shown in the diagram below.
- Cables with the connections shown below and the special accessory RS-232 cable are not guaranteed to operate properly for all types of computers and devices.

For DOS/V computers (D-sub9 pin) (Null-modem)

Computer side			Balance side		
RXD	2	-----	2	TXD	
TXD	3	-----	3	RXD	
DTR	4	-----	6	DSR	
SG	5	-----	7	SG	
DSR	6	-----	20	DTR	
RTS	7	□	□	5	CTS
CTS	8			4	RTS

15.2.2 Data Format

The detailed information on the standard format for Shimadzu electronic balances (Menu item **77**, "EB type". Refer to 15.3.3) is given here.

(1) Basic format

An example of data format of a negative value (-186.65g) with delimiter of C/R is shown.

The data length varies depending on attached information, unit expression and delimiter as explained in (2).

Data length of this example: 12 bytes												
Position	1	2	3	4	5	6	7	8	9	10	11	12
ASCII code	2DH	20H	20H	31H	38H	36H	2EH	36H	35H	67H	20H	0DH
Data	-			1	8	6	.	6	5	g		C/R

Remarks

Position 1: For a positive value, " " (space) (20H), and for a negative value, "-" (2DH) is in this position.

Positions 2 to 9: The absolute value. When the numerical value does not use all the 8 positions, the code for space is entered to each excessive position as shown in this example.

Positions 10,11: One or two letters indicating the weighing unit. As shown in this example, the code for space is entered at position No.11 if only one letter is used for the unit.

Position 12: Code for delimiter.

(2) Information of additional bytes

(i) Output with stability information

When outputting data with stability information (Refer to 15.2.3 (4)-(i)), either of the following characters is added in front of Character No.1 in the example. Consequently, the data becomes 1 byte longer.

When stable: S

When unstable: U

(ii) Verified balance as a legal measuring instrument

The brackets "[]" bordering auxiliary indicating device of legal measuring instrument can also be outputted. In this case, "[" and "]" are inserted according to their positions in the weighed data. They come to the positions before and after Position No.9 in the example. Consequently, the data becomes 2 bytes longer.

(iii) Unit expressed with three letters

Some weighing units are expressed with three letters. Therefore one more byte is inserted after Position No.11 in the above example. Consequently, the data becomes 1 byte longer.

15. Connecting Peripheral Instruments

(iv) When the delimiter “C/R+L/F” is selected (Menu item No. 96. Refer to 15.3.7.)

The delimiter information requires one more character. Therefore one more byte is added after Position No.12 in the above example. Consequently, the data becomes 1 byte longer.

(3) Data format in case of “oL” or “-oL” (Overload)

The below is the data format for “oL”.

Data length of this example: 12 bytes												
Position	1	2	3	4	5	6	7	8	9	10	11	12
ASCII code	20H	20H	20H	20H	20H	4FH	4CH	20H	20H	20H	20H	0DH
Data						O	L					C/R

For “-oL” (negative overload), Position 1 is replaced with “-” (minus, ASCII code: 2DH).

The following parts appearing in “(2) Information of additional bytes” also apply to (3).

(i) Output with stability information

(iv) When the delimiter “C/R+L/F” is selected

15.2.3 Using Command Codes



Note

If communication conditions are incorrectly set, a communication error message "ComErr" is displayed.

- (1) Commands that end with a number, character, or symbol other than [=]: Transmit to the balance with a delimiter for each command code.

Example 1: PRINT<CR> ... The same operation as pressing the [PRINT] key

- (2) Commands that end with a [=]: Transmit the number to the balance with a delimiter.

Example 2: TIME=1234 <CR> .. 12:34 is set as the current time.

Example 3: P.TARE=1.23 <CR> (example of type of the second decimal place).
...1.23g is set as a Pretare value.

Example 4: P.TARE=0.00 <CR> (example of the second decimal place)
...Clears (cancels) the Pretare value.



Note

Number of digits, decimal point, position of decimal point of the numeral transmitted succeeding to '=' are the same as the case of setting the numeric value using the AKB-301 Application Keyboard.

Use the same number of decimal places as in the gram-display.

This restriction does not apply to USER=, SOLID=, and LIQUID=.

Example 5: MENU=4630 <CR> (4-digit number after [=])

This is the same in the following operation.

.. from mass display, press the [CAL] key five times, then press the [O/T] key once and the press the [CAL] key six times. This returns to the same display as if the [CAL] key was never pressed.

Press the [O/T] key once, then [CAL] key three times, and the [O/T] key once more.

This example indicates that menu item **25** (Anti-vibration mode) is selected.

**Notes**

- If there is 0 in the four-digit number, the setting is complete at that point and menu selection is ended.
- The result of this command varies depending on the type of the balance.

Example 6: #=2.56 <CR>

Example 7: #=12.345.67 <CR>

A personal computer can instruct the weighing and display a specific number on the balance.

With the commands in Example 6 & 7, [#2.56] and [#12.345.67] are displayed on the balance. When the operator presses the **[PRINT]** key, the character string '2-56<CR>' and '12-345-67<CR>' are output from the balance.

(3) Echo back command

The balance again transmits the character strings of N pieces included between an echo back command '{' or '}' and the delimiter.

An unprocessed echo back command is not left in the receiving buffer of the balance, $N \leq 30$.

Example 8: ABCDEFG12345<CR>

... After receiving this command, the balance outputs ABCDEFG12345<CR>.

The printer can print this character string.

**Note**

Only capital alphabets and a part of symbols (decimal point, symbol etc.) can be used when printing with an electronic printer. A maximum of 15 characters per line.

(4) Command codes for Format EB type (menu item **77**) and Format Old EB type (menu item **78**)

(i) **Commands related to output**

D01	Continuous output*	} (The balance continuously outputs every about 80ms**)
D03	Continuous output with stability information*	
D05	Single output	
D06	Auto Print setting (type of Auto Print is set separately)	
D07	Single output with stability information***	
D09	Release of continuous output and Auto Print	

***Not applicable to a verified balance as a legal measuring instrument in using region**

****Handshake is "OFF" or "Hardware"**

*****Using a verified balance as a legal measuring instrument:
Only output at stable.**

(ii) Commands related to operation keys

POWER	Equivalent to the [POWER] key.
Q	Equivalent to the [POWER] key.
MENU	Equivalent to the [CAL] key.
TARE	Equivalent to the [O/T] key.
T	Equivalent to the [O/T] key.
UNIT	Equivalent to the [UNIT] key.
PRINT	Equivalent to the [PRINT] key.
POWER+	Equivalent to holding the [POWER] key for approximately 3 seconds.
MENU+	Equivalent to holding the [CAL] key for approximately 3 seconds.
UNIT+	Equivalent to holding the [UNIT] key for approximately 3 seconds.
PRINT+	Equivalent to holding the [PRINT] key for approximately 3 seconds.
RECALC	Equivalent to the [RECALC] key of the AKB-301 Application Keyboard.
C	Equivalent to the [C] key of the AKB-301 Application Keyboard.

(iii) Commands related to application measurement

PEAK	Sets the Peak Hold mode.*
AZERO	Sets the Auto Zero mode ON.*
INTERVAL	Sets the Interval Timer mode.*
MEMORY	Sets the Formulation mode.
M	Immediately operates after setting the Formulation mode.
ADDON	Sets the Add-on mode.
+	Immediately operates after setting the Add-on mode.
A	Sets the Animal Weighing mode.*
ANIMAL	Sets the Animal Weighing mode.*
R	Releases the Application weighing mode.

(iv) Commands related to unit conversion

g	Switches to "g" unit.
kg	Registration of "kg" unit and switching.
mg	Registration of "mg" unit and switching.*
PERCENT	Registration of "%" unit and switching.
%	Sets 100% when display is in "%" unit.
G	g \leftrightarrow % switching.
PCS	Registration of "PCS" unit and switching.
CT	Registration of "carat" unit and switching.
MOM	Registration of "momme" unit and switching.*
SDENSE	Registration of "solid density" unit and switching.
LDENSE	Registration of "liquid density" unit and switching.
CU	Switches to "user" unit (Set the conversion coefficient beforehand.).
RSTUNIT	Returns the default units.

***Not applicable to a verified balance as a legal measuring instrument in using region**

(v) Readout commands of set value

TARGET	Readout of target set value.
LIMIT	Readout of limit set value.
G.LO	Readout of lower limit set value in Checkweighing Display 1.
G.LO	Readout of upper limit set value in Checkweighing Display 1.
L.LO	Readout of lower limit set value in Checkweighing Display 2.
L.UP	Readout of upper limit set value in Checkweighing Display 2.
UW	Readout of unit weight set value.
G/PCS	Equivalent to g/PCS key.
CALWT	Readout of external weights set value for span calibration.*
ACALT1	Readout of Clock-CAL time 1.
ACALT2	Readout of Clock-CAL time 2.
ACALT3	Readout of Clock-CAL time 3.
P.TARE	Readout of Pretare set value.*
ZRNG	Readout of Zero Range set value.
USER	Readout of user unit conversion coefficient.*
VOL	Readout of reference weight set value.
DENSE	Readout of surrounding liquid density set value.
I.TIME	Readout of Interval Timer set value.*

(vi) Commands for numeric value setting

CALWT=	Sets external weights value for span calibration.*
ACALT1=	Sets Clock-CAL time 1.
ACALT2=	Sets Clock-CAL time 2.
ACALT3=	Sets Clock-CAL time 3.
P.TARE=	Sets Pretare value.*
ZRNG=	Sets Zero Range value.
UW=	Sets unit weight.
USER=	Sets user unit conversion coefficient.*
VOL=	Sets volume of reference weight.
SDENSE=	Sets surrounding liquid density.
I.TIME=	Sets interval timer value.*
DATE=	Sets the date.
TIME=	Sets the time.
TARGET=	Sets the target value.
LIMIT=	Sets the limit value.
G.LO=	Sets the lower limit value of Checkweighing Display 1.
G.UP=	Sets the upper limit value of Checkweighing Display 1.
L.LO=	Sets the lower limit value of Checkweighing Display 2.
L.UP=	Sets the upper limit value of Checkweighing Display 2.
PCS=	Sets the arbitrary loading piece.
#=	Corresponds to numeral keys of AKB-301 Application Keyboard.
ID=	Sets ID.
PASSSET=	Sets PCAL password.*
PASS=	Inputs PCAL password.*

***Not applicable to a verified balance as a legal measuring instrument in using region**

(vii) Commands of special functions

CAL	Enters Span Calibration mode.
C18	Enters Span Calibration mode.
LOCK	Sets menu lock.
RELEASE	Releases menu lock.
TIME	Readout of date and time.
ADJCLK	Adjusts ± 30 seconds.
RSTMN	Menu reset.
MENU=	Sets arbitrary menu.
{	Echo back.
}	Echo back.
[α]	Sets to Multi-Connection mode. (α represents a lower-case alphabet character.)

**Note**

For Multi-Connection mode, refer to Section [“15.2.4 Multi-Connection Mode”](#).

(5) Compatible commands with Mettler Toledo® PR and SR series Electronic Balances

S	One time output at a stable state
SI	Immediate one time output*
SIR	Continuous output*
SR	Continuous output at a stable state
T	Taring after stabilized
TI	Immediate taring*
Z	Zero setting (same as immediate taring)*

(6) Compatible commands with Sartorius® IS series Electronic Balances

<ESC>P	One time output
<ESC>T	Taring

**Note**

<ESC> indicates escape code (1BH).

15.2.4 Multi-Connection Mode

A maximum of 26 UW/UX series balances can be connected to one personal computer at the same time. This is called “Multi-Connection mode.” To use the balance in this mode, prepare RS-232C cables in the number of balances connected, and the optional IFB-102A RS-232C Interface.

Connecting Method

Example for connecting 10 units of UW/UX series balances to one personal computer is shown in the diagram below.

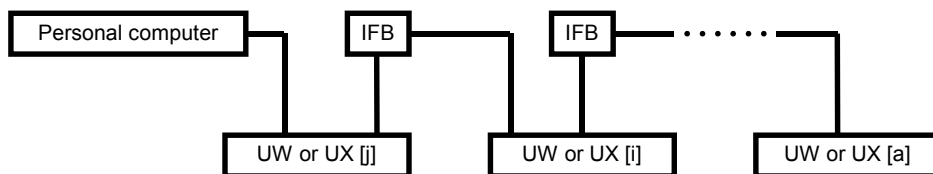

Assignment of Identification Name

In this example (10 balances connected to one computer), assign the identification name in lower-case alphabets.

Since 10th character of alphabet is “j,” assign “j” to the balance closest to the personal computer, “i” to next closest balance, and so on, back to “a.”

Setting to Multi-Connection Mode

- 1** Adjust the communication menu settings of all the balances to the specification of the personal computer, and then, turn off the power to all balances.
- 2** Start supplying the power to the whole system. Wait until all balances display OFF.
- 3** Send “[α] <delimiter>” from the personal computer.
 α is the name of the balance next to the personal computer. In the example above, lower-case “j.”
 This command is valid only one time after turning the power ON.
 Respective balances automatically enter the Multi-Connection mode and the mass is displayed.

On this process, the name smaller than the sent command by one, i.e. “[i] <delimiter>”, is returned.

4 This procedure completes the setting to the Multi-Connection mode.

BALANCE (No)	Command (PC)	RETURN DATA (PC)
a	[a] PRINT	[a] PRINT 0.0g
b	[b] PRINT	[b] PRINT 0.0g
c	[c] PRINT	[c] PRINT 0.0g
d	[d] PRINT	0.0g
(nearest to PC)		(No Data)

Command Codes in the Multi-Connection Mode

Only the commands shown below are valid in the Multi-Connection mode.

(α is the name of the balances.)

[α]TARE	Same as the operation of pressing the [O/T] key of the balance “ α ”.
[α]T	Same as the operation of pressing the [O/T] key of the balance “ α ”.
[α]POWER	Same as the operation of pressing the [POWER] key of the balance “ α ”.
[α]Q	Same as the operation of pressing the [POWER] key of the balance “ α ”.
[α] PRINT	Same as the operation of pressing the [PRINT] key of the balance “ α ”.
[α]D05	Same as the operation of pressing the [PRINT] key of the balance “ α ”.
[α]D07	Same as sending the D07 command to the balance “ α ”.
[α]UNIT	Same as the operation of pressing the [UNIT] key of the balance “ α ”.
[α]CAL	Same operation as sending the CAL command to the balance “ α ”.
[α]UNIT+	Same as the state of holding down the [UNIT] key of the balance “ α ”.

Format of Output Data from the Balance

The output data from the balance “ α ” is performed with the following format.

“[α]” data <delimiter>

Format of the load data is the same as the normal output form (Format EB type).

Operation is not guaranteed for the data containing characters, such as printing of date, time, and calibration document etc.

Restricted Items in the Multi-Connection Mode

- Multi-Connection mode is not designed for each balance to independently send the data. This mode is for sampling the data by control of multiple balances with one PC. This is not the function to support multiple balances for sending the data separately. When multiple number of data and commands exist on the system at the same time, the balance may not operate normally. For example, multiple data may exist simultaneously on the system when using multiple balances in the Application Measurement mode such as Auto Print or Continuous Output, or pressing the **[PRINT]** key. Normal operation cannot be guaranteed.
- Peripheral instruments connected to the DATA I/O or IFB-102A connector, such as an EP-50 Electronic Printer, cannot be used.
- The communication formats can only be used with "Format EB type". Delimiters cannot be used with menu items **[97]** or **[98]** (setting for WindowsDirect).
- It will take an average $0.05 \times N$ seconds for the data from the personal computer to reach balance unit N, even at setting of 38400 bps. Also, it will take almost the same time for the data from the balance in the Nth position to reach the personal computer.

Cancellation of Multi-Connection mode

Multi-Connection mode cannot be canceled unless the power for all balances is turned OFF.

15.3 Communication Setting

15.3.1 Overview

This menu is used to set the specifications for communication between the balance and a personal computer or electronic printer.



Notes

- This menu affects both the RS-232C and DATA I/O at the same time. For the instrument to be connected to the DATA I/O connector such as an electronic printer, select the communication setting of the balance to the default settings, which are menu items **76**, **77**, **83**, **89**, **92**, **94**. However, select WindowsDirect setting (6.2.1) and follow the manual of the electronic printer when using EP-80 or EP-50WIN Electronic Printer simultaneously with WindowsDirect.
- When WindowsDirect function is set by the procedure described in 6.2.1, the communication settings are the same as selecting menu items **74**, **77**, **81**, **89**, **92**, **97**.

15.3.2 Handshaking

Handshaking determines whether the peripheral equipment can receive communication data from the balance. This function does not relay the status of the balance to the peripheral equipment.

The balance is able to receive as long as there is space in the receiving buffer of the balance. This function operates once “oFF” is displayed, operation in other states is not guaranteed.

When the balance output is retained by handshaking, the display of the balance is locked. Determine the specifications for handshaking.

To have software handshaking not performed, select menu item **73**.

To have software handshaking performed as the following, select menu item **74**.

After the balance receives X-OFF (13H), the balance output is retained.

After the balance receives X-ON (11H), the balance output is initiated.

To have hardware handshaking performed as the following, select menu item **75**.

When DTR is OFF, the output from the balance is retained.

When DTR is ON, the output from the balance is initiated.

To have timed hardware handshaking performed, select menu item **76**.

15.3.3 Format

Set the balance output data format.

The standard format for the Shimadzu electronic balance: Select menu item **77**.

The old output format for the Shimadzu electronic balance: Select menu item **78**.

The old output format is employed in the following models.

EB-500, 5000, 280, 2800, AEL-1600, EB-50K (except -15)



Note

In this format, the number of the lowest place of menu item **70** is assigned to identify the balance.

Compatible format for the PR and SR series of Mettler-Toledo electronic balances. Available commands, functions and responses are limited: Select menu item **79**.

Compatible format for the IS series of Sartorius electronic balances. Available commands, functions and responses are limited: Select menu item **80**.

15.3.4 Communication Speed

Select the communication speed (300, 600, 1200, 2400, 4800, 9600, 19200, or 38400 bps).

Number of "b-xxx" shows bps (bits/second). Baud rate and bps are the same value.

Select one of the menu items **81** to **88**.

15.3.5 Parity / Bit Length

Select the parity and bit length.

No parity, 8-bit length: Select menu item **89**.

Odd number parity, 7-bit length: Select menu item **90**.

Even number parity, 7-bit length: Select menu item **91**.

15.3.6 Stop Bit

Select the number of stop bits.

Stop bit 1: Select menu item **92**.

Stop bit 2: Select menu item **93**.

15.3.7 Delimiter

The “delimiter” is used to separate individual pieces of data or commands. Set the delimiter as follows:

Set to CR(0DH): Select menu item **94**.

Set to LF(0AH): Select menu item **95**.

Set to CR+LF(0D0AH): Select menu item **96**.

WindowsDirect setting (down) :

equivalent to pressing the Enter key of the computer after typing the value:

Select menu item **97**.

WindowsDirect setting (right) :

equivalent to pressing the right arrow key of the computer after typing the value:

Select menu item **98**.



Note

Settings for “WindowsDirect” (menu items **97** and **98**)

When these menu items are selected, it is not possible to send commands to the balance from the peripheral instruments.

15.4 Decimal Point Symbol in Output Data

The decimal point symbols in the outputted data to external devices can be selected from “.” (period) or “,” (comma) depending on your preference. Note that the decimal point expression on the balance display is always with “.” (period).

To select “.” as outputted decimal point, select menu item number **72a**. “dECP-Pr”

To select “,” as outputted decimal point, select menu item number **72b**. “dECP-Cn”



Note

The setting made here in “Decimal Point Symbol in Output Data” will not be cleared with Menu reset (See [7.5.2](#)).

16. Maintenance and Transportation

16.1 Maintenance

Use a soft damp cloth containing a neutral detergent to clean the balance.

Avoid using organic solvents, chemicals, or dusting sprays as they may damage the coatings of the balance or the display panel.

Attach the protective in-use cover (standard accessory) when the balance is used in an environment where it is susceptible to being soiled.

The pan can be removed and washed with water. Verify that the pan is completely dry before replacing it on the balance.

16.2 Moving the Balance

To carry the balance, hold the balance firmly with both hands.

To transport the balance, use the shipping carton used to deliver the balance.

For UW balances: Before placing the balance into the shipping carton, remove the pan and pan supporter caps and verify that the transportation screws in the bottom of the balance have been tightened clockwise until they stop. Refer to [4.3](#).

For UX balances: Remove the pan and pan supporter caps and place the balance in the packing case as it was shipped.



Caution

Failing to tighten the transportation screws, placing the balance on its side when turning the transportation screws, or failing to remove pan supporter caps before placing the balance upside down may cause serious damage to the mechanism.



Note

Using a verified balance as a legal measuring instrument in using region: Span calibration must be newly performed with the built-in calibration weight after the balance has been moved and re-installed.

17. Troubleshooting

17.1 General Display

Display	Description of message
---	Wait for next display.
- 10d -	Minimum display resolution is decreased by one decimal place.*
- 1d -	Minimum display digit is returned to original state.*
-t ime-	Date and time are being output.
Abort	Operation was aborted.
APL End	Application Measurement was released.
d ouEr	Calibration check detects too large error. (Contact your Shimadzu representative.)
d UndEr	Calibration check detects too large error. (Contact your Shimadzu representative.)
LoCKEd	Menu lock is applied.
rELeARSE	Menu lock is released.
rESEt	Menu was reset.
SEt	Contents of new setting and coefficient were stored.
oFF	Reset by power failure.
wa it	Built-in weight is moving. Wait.
All numerals blinking	Place the displayed calibration weight.

*Not applicable to a verified balance as a legal measuring instrument in using region

17.2 Error Display

Error display	Description	Countermeasure
CAL E0	Trouble in weight loading mechanism	Check transportation screws.
CAL E1	The load on the pan is unstable at calibration.	Avoid wind and vibration.
CAL E2	The drift of zero point is large at calibration.	Install the pan properly. Unload the pan.
CAL E3	The drift is large at the time of PCAL.	Use correct weight.
CAL E4	The drift is large at span calibration.	Use correct weight.
CAL E5	Calibration weight is wrong.	Use correct weight.
CHE x	Failure in the balance (Stops when this is displayed)	*
ComErr	Received command code is not correct.	Check delimiter etc.
dSP oL	Integer of the displayed unit exceeded 7 digits.	Decrease the load.
Err 0x	Failure in the balance.	*
Err 10	PCAL password error.	Check the password.
Err 20	Attempted to set improper numeric value.	Review the numeric value and decimal places.
LoCKEd	Menu item selection was attempted when menu is locked.	Release menu lock. (Refer to 7.5.3)
Err 24	Supply voltage is abnormal.	Check the supply voltage.

* Contact your Shimadzu representative.

17.3 Troubleshooting

Symptom	Probable cause(s)	Countermeasure
Nothing is displayed.	<ul style="list-style-type: none"> The AC adapter is disconnected. The breaker of the room is off. The voltage is wrong. 	Check the power and connect AC adapter correctly. (See 4.1)
"OL" or "-OL" is displayed.	Transportation screws haven't been loosened.(UW only)	Turn them anti-clockwise until they stop. (See 4.3)
	The pan is displaced.	Place the pan properly.
	Pan supporter caps are not installed.	Install pan supporter caps. (See 4.3)
	The load on the pan is too large.	Use balance within its capacity.
Display does not change when pan is loaded.	Pan is displaced.	Place the pan properly.
Display fluctuates.	Affected by vibration or air flow.	Install the balance at a proper site. (See 4.1) Try changing environment settings. (See 11.)
	Protective in-use cover touches the pan.	Adhere the cover firm to the balance body. (See 4.3)
The weighed result is not accurate.	Span calibration has not been done.	Calibrate it properly. (See 10.)
	Taring has not been done.	Tare before weighing. (See 5.1)
Does not display the unit desired to use.	The unit has not been set up	Set it up in advance. (See 12.)
Menu item selection is rejected.	Menu Lock is ON.	Release Menu Lock. (See 7.5.3)
WindowsDirect does not work.		See "6. WindowsDirect Function"
An error code is shown.		See "17.2 Error Display"

17.4 LCD (Liquid Crystal Display) Check

By selecting the whole lighting mode, the LCD can be easily inspected upon power is connected.

To have the display stop and hold at whole lighting after power is connected, select the menu item **37**.

When the display holds, press the **[O/T]** key to proceed to the mass display.

To have the display stop and proceeds to the mass display automatically, select the menu item **38**.

(Refer to chapter 7 for menu item selection.)

If the display is not the same as the figure in 2.3, contact your Shimadzu representative.

Appendices

A-1. Menu Map

- Pressing **[CAL]** key moves to the next menu in the same hierarchy. (↓ in menu map)
- Pressing **[O/T]** key moves to the menu of one hierarchy down. (→ in menu map)
When no menu exists in the menu of one hierarchy down, it is fixed.
- Pressing **[POWER]** key returns to the menu of one hierarchy up. (← direction in menu map)

Refer to 7.3 for menu item selection.

Important Note on Menu Item Selection

Even the desired menu item is reached and displayed, it is not yet set unless Stability mark (→) is illuminated with it. Do not fail to **press [O/T] key** to put Stability mark before returning to the mass display.

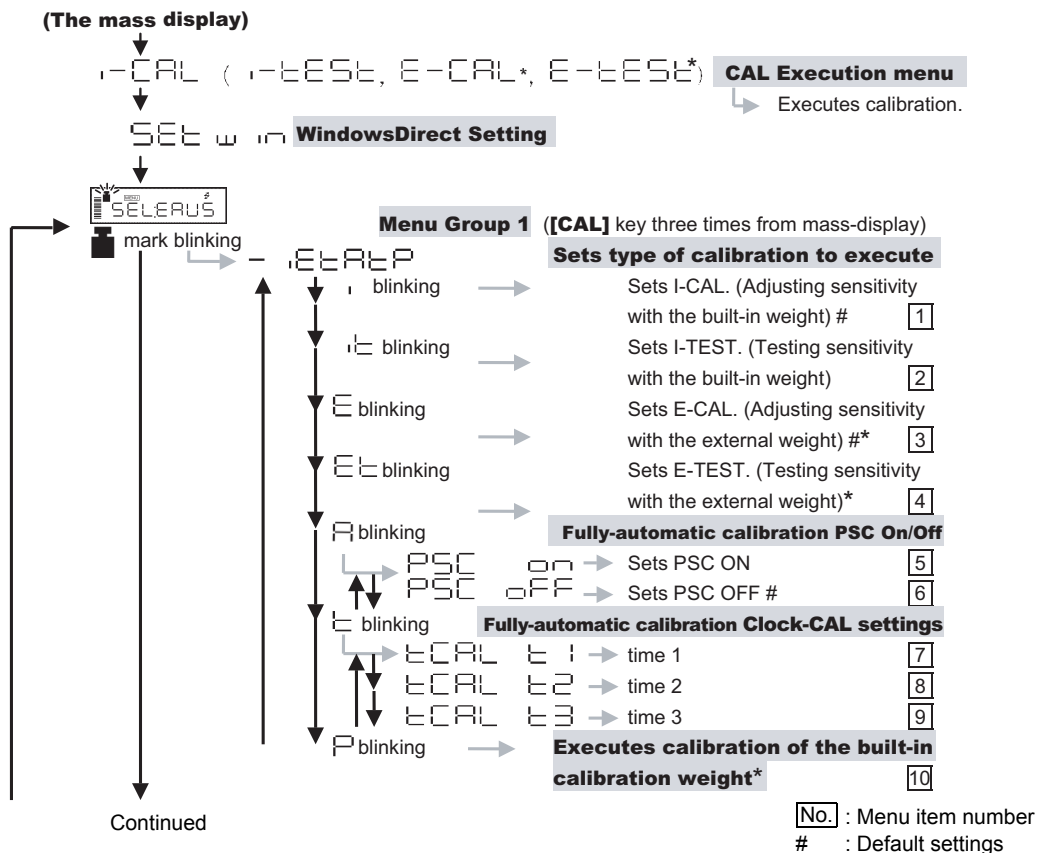

*Not applicable to a verified balance as a legal measuring instrument in using region

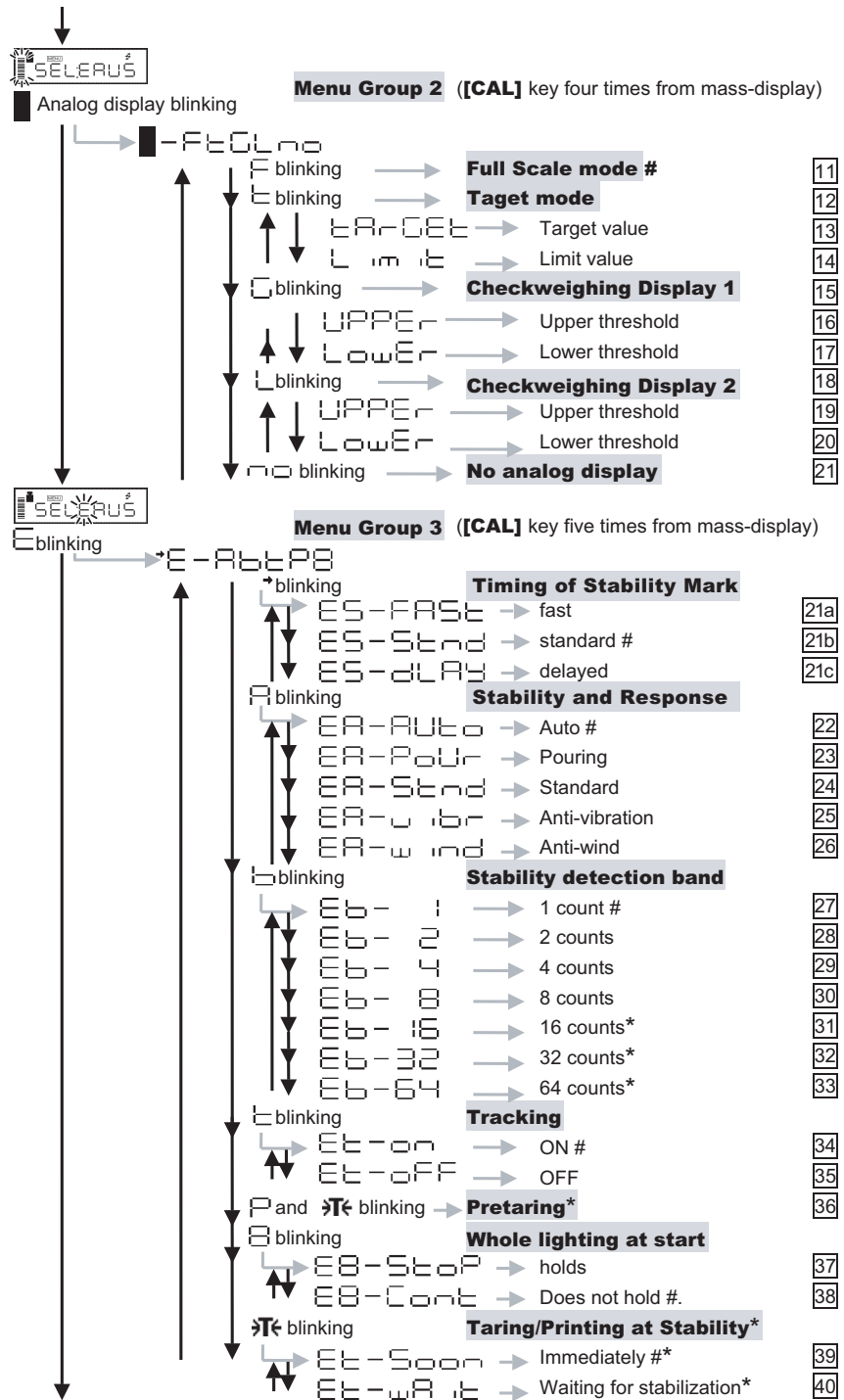

Continued

[No.] : Menu item number
: Default settings

***Not applicable to a verified balance as a legal measuring instrument in using region**

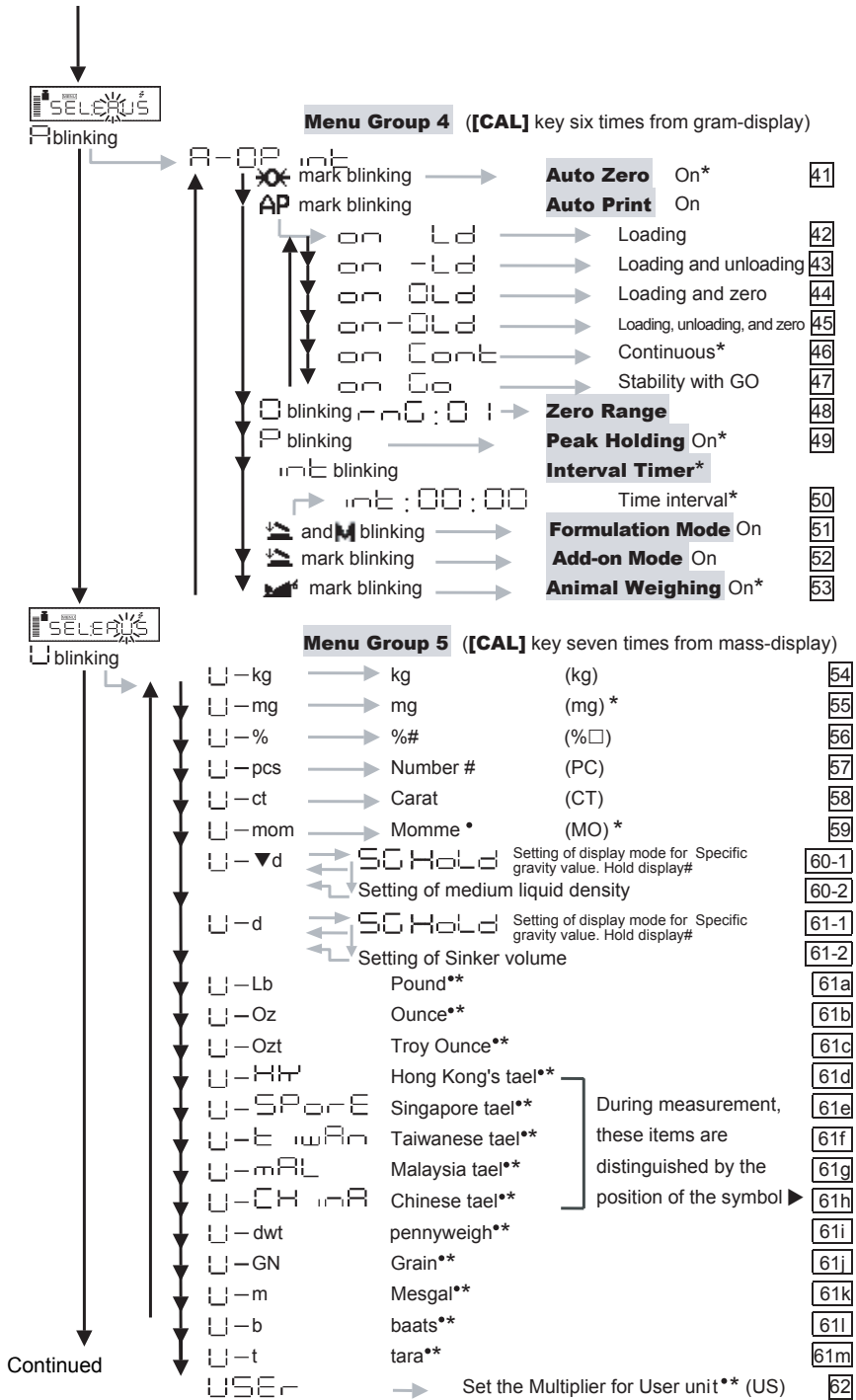

[No.] : Menu item number
 # : Default settings
 * : These units cannot be selected in some countries due to legal restriction.

***Not applicable to a verified balance as a legal measuring instrument in using region**

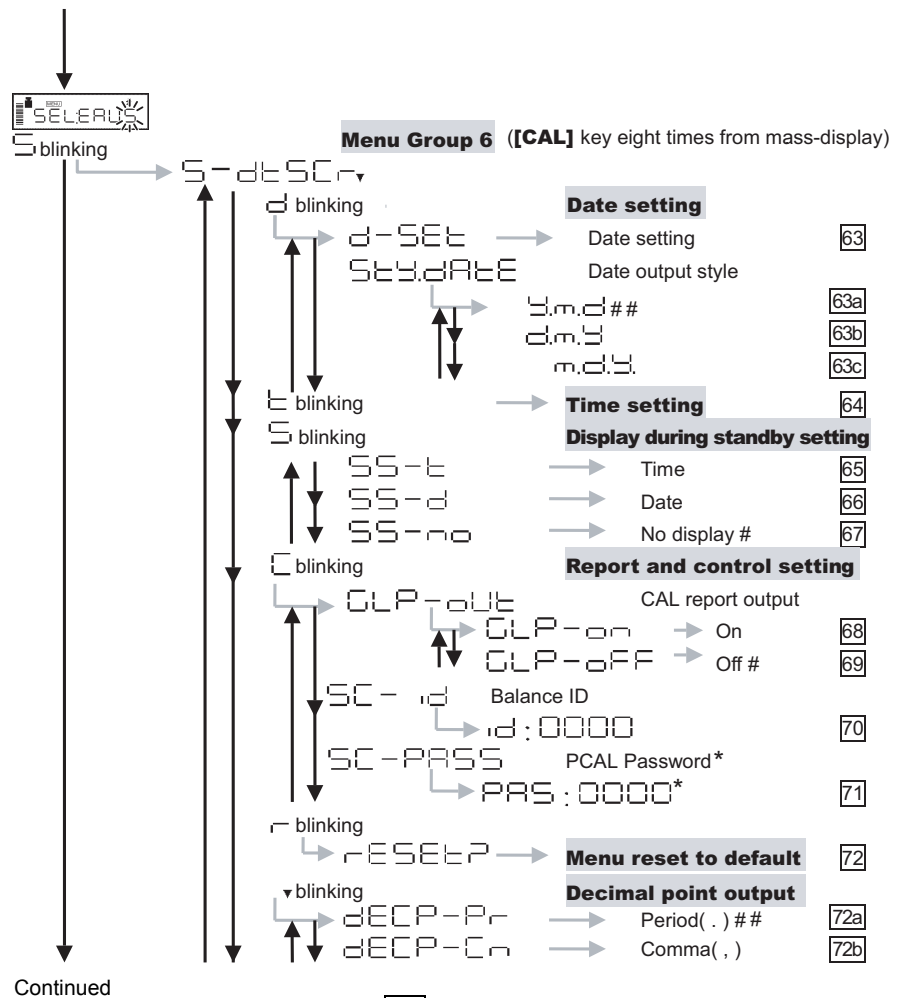

- [No.] : Menu item number
- # : Default settings.
Settings are initialized to default by "Menu reset".
- ## : Default settings.
Settings are not initialized to default by "Menu reset".

*Not applicable to a verified balance as a legal measuring instrument in using region

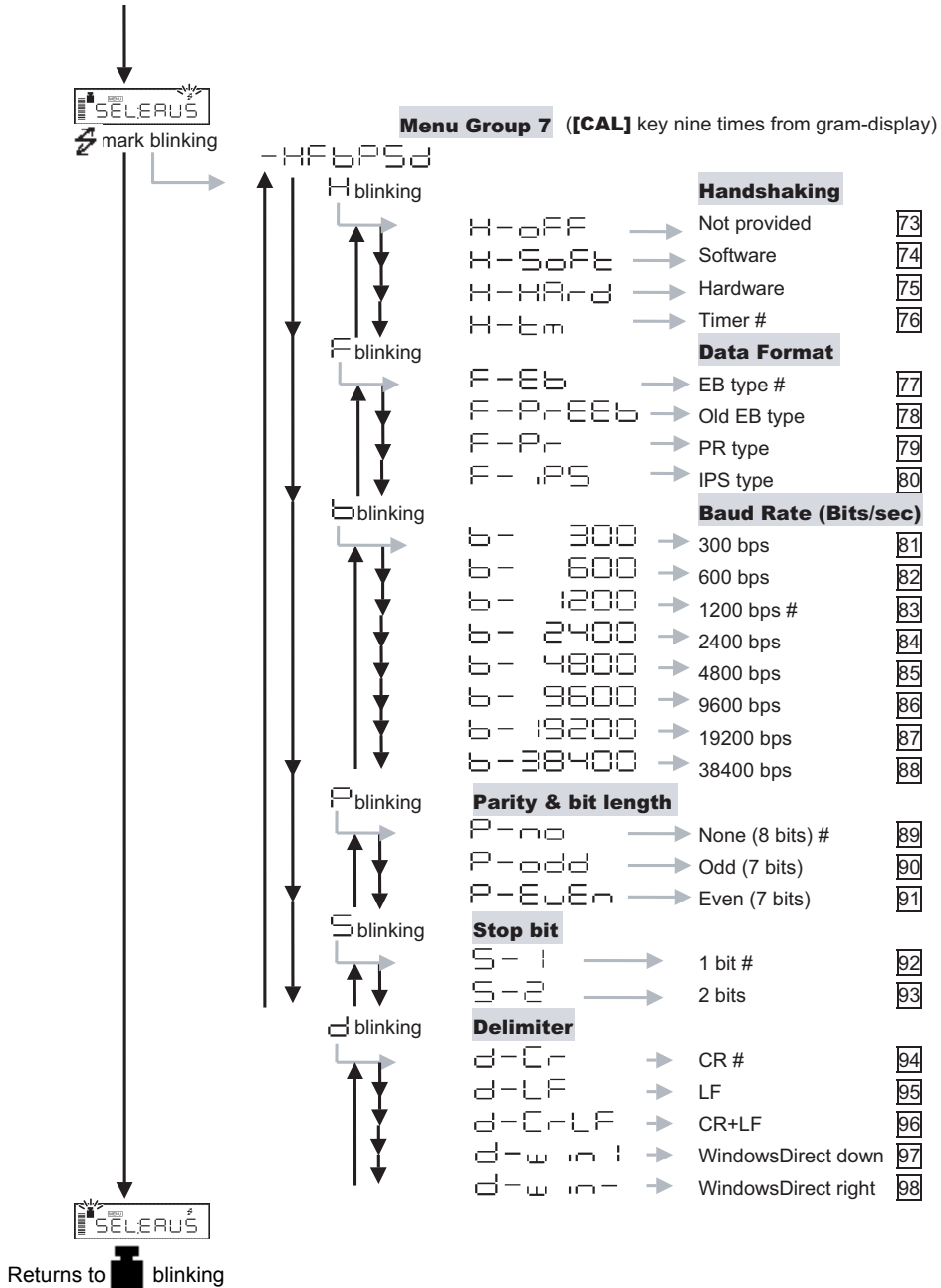

[No.] : Menu item number
: Default settings

A-2. Standard Accessories and Maintenance Parts List

Item	Part number	Description
Pan (large pan)	321-51555	
Pan (small pan)	321-51556	
Pan supporter cap (for large pan)	321-51552-02	
Pan supporter cap (for small pan)	321-51552-01	
In-use protective cover	321-62395	For display and key part
In-use protective cover (5 pieces)	321-62395-10	For display and key part
Level screws	321-53530-30	
Windbreak main	321-62799-01	Standard for models with minimum display of 0.001g only
Windbreak lid	321-62798-01	
Windbreak fixing knob (1 piece)	321-62787	
Windbreak Set	321-62797	Set of 321-62799-01, 321-62798-01 and 2 pieces of 321-62787
Rubber cap (1 piece)	321-62794	For small pan model
AC adapter	Contact your distributor	
Below-weigh hook cap	321-51572-04	

A-3. Optional Accessories List

Item	Part number	Part number for RoHS	Description
EP-80 Electronic Printer	321-62675-01 (w/o AC adapter)	321-80016-01 (w/o AC adapter)	Impact dot print, can be used with WindowsDirect
EP-90 Electronic Printer	321-62675-11 (w/o AC adapter)	321-80016-11 (w/o AC adapter)	The EP-80 with a numeric keypad
RS-232C Cable 25P-9P (1.5m)	321-60754-01		For PC/AT, DOS/4 serial port
IFB-102A RS-232C Interface	321-41167-10		Necessary for multi-connection
IFB-102A-UNC RS-232C Interface	321-41167-20		Inch-size screws type, Necessary for multi-connection
AKB-301 Application Keyboard	321-53382-01		
Remote Display RDB-201	321-53600-01		With operation keys
Remote Display RDB-202	321-53600-02		Without operation keys
Windbreak Set	321-62797		For small pan model only (Standard for models with minimum display of 0.001g)
WBC-102 Glass Windbreak	321-62795		For small pan model only (with three sliding doors)
WBC-502 Large Size Windbreak	321-53537		For all models (opens upward with hinges)
FSB-102PK Foot Switch	321-60110-11		The same effect as [PRINT] key
FSB-102TK Foot Switch	321-60110-12		The same effect as [O/T] key
Animal Bucket Set	321-62150		For animal weighing, for large pan model only
Specific Gravity Measurement Kit SMK-101	321-60576-01		For large pan model only
Specific Gravity Measurement Kit SMK-102	321-60576-12		For small pan model only (except for UW/UX220H)
In-use protective cover (for large-pan model) (5 pcs)	321-61228		Covering whole main body
In-use protective cover (for small-pan model) (5 pcs)	321-61229		Covering whole main body



Note

Part number and specification are subject to change without notice.
It is not guaranteed that RS-232C cable will conform to all computers.

A-4. Specifications of Connectors

RS-232C Connector

Pin No.	Name	Function
1	FG	Frame ground
2	TXD	Data output
3	RXD	Data input
4	RTS	Internal connection with CTS
5	CTS	Internal connection with RTS
6	DSR	Handshake (receiving)
7	SG	Signal grounding
8	NC	Blank
9	NC	Blank
10	NC	Blank
11	NC	Blank
12	NC	Blank
13	NC	Blank
14	NC	Blank
15	NC	Blank
16	NC	Blank
17	NC	Blank
18	NC	Blank
19	NC	Blank
20	DTR	Handshake (transmission)
21	NC	Blank
22	NC	Blank
23	NC	Blank
24	NC	Blank
25	NC	Blank

KEY Connector

(When used for checkweighing output)

Pin No.	Name	Function	Remarks
1	GND	Ground of checkweighing	
2	OPERATION	Output during weighing	Checkweighing output is O.C. (open collector). Capacity: 5 to 24VDC, 0 to 20mADC
3	STABILITY	Output while balance display is stable.	
10	LO	LO signal output	
11	GO	GO signal output	
12	HIGH	HI signal output	
13	ZERO	Output while balance display is zero	
9		Pin 9 and Pin 15 must be short-circuited by the external device in order to use KEY Connector for checkweighing signal output.	
15			

Concept of Open Collector Circuit

(n= 2,3,10,11,12,13)

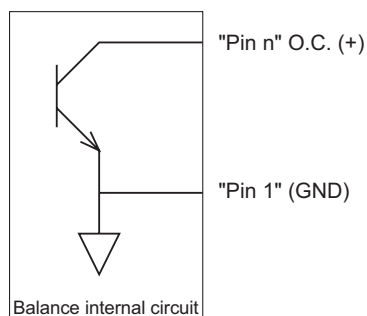

A-5. Table of Unit Conversion Constants

Menu item number	Display			Unit	Conversion coefficient (1g=)	Minimum display in the unit (models with minimum display of 0.01g, as examples)
	Center section (segmented character display)	Unit display section	Illuminated triangular symbols in the right end row of the display; numbered from 1 to 4 from the top.			
54	<i>U-</i>	kg	none	kg	0.001	0.00001
55	<i>U-</i>	mg	none	mg*	1000	10
56	<i>U-</i>	%	none	percentage	_____	_____
57	<i>U-</i>	pcs	none	piece counting	_____	1
58	<i>U-</i>	ct	none	carat	5	0.1
59	<i>U-</i>	mom	none	momme*	0.266667	0.005
60	<i>U-</i>	▼ d	none	solid specific gravity	_____	_____
61	<i>U-</i>	d	none	liquid density	_____	_____
61a	<i>U-</i>	lb	none	Lb (pound)*	0.00220462	0.00005
61b	<i>U-</i>	oz	none	Oz (ounce)*	0.035274	0.0005
61c	<i>U-</i>	ozt	none	Ozt (troy ounce)*	0.0321507	0.0005
61d	<i>U-HK</i>	tl	1	Hong Kong tael*	0.0267165	0.001
61e	<i>U-HK</i>	tl	2,3,4	Hong Kong tael (jewel) *	0.0267173	0.001
61f	<i>U-SPorE</i>	tl	2	Singapore tael*	0.0264554	0.001
61g	<i>U-twn</i>	tl	3	Taiwan tael*	0.0266667	0.001
61h	<i>U-twn</i>	tl	1,2,4	Taiwan tael*	0.0266667	0.0002
61i	<i>U- mAL</i>	tl	4	Malaysia tael*	0.0264600	0.0005
61j	<i>U-CHinA</i>	tl	none	China tael*	0.0266071	0.0005
61k	<i>U-CHinA</i>	tl	1,2,3,4	China tael*	0.0266071	0.001
61l	<i>U-</i>	dwt	none	dwt (pennyweight)*	0.643015	0.01
61m	<i>U-</i>	GN	none	GN (Grain)*	15.4324	0.2
61n	<i>U-</i>	t	none	tola*	0.0857339	0.001
62	<i>U-USER</i>		4	User unit*	_____	_____

*Not applicable to a verified balance as a legal measuring instrument in using region

A-6. Performance Checks

Not applicable to a verified balance as a legal measuring instrument in using region



Notes

- Performance checks should be conducted in a room where there are no sudden temperature changes. Refer to the installation guidelines for the environmental factors that assure optimal performance.
- The following is a standard method used to determine whether the balance is working properly.
- The specific criterion should be set according to each user's quality goal.

Repeatability

- 1 Allow the balance to warm up sufficiently by turning ON the power and leaving it at the gram-display at least two hours before starting the performance checks.
- 2 Choose a weight that is near half the capacity of the balance. Load and unload the weight five successive times and record the following items:
 X_i : Displayed value when the weight is loaded.
 Y_i : Displayed value when the weight is unloaded.
- 3 Use the formulas shown below to calculate the values R_x and R_y .
- 4 Balance repeatability is considered normal when both R_x and R_y are within five counts.
 * One count corresponds to one minimum display unit of the balance model.

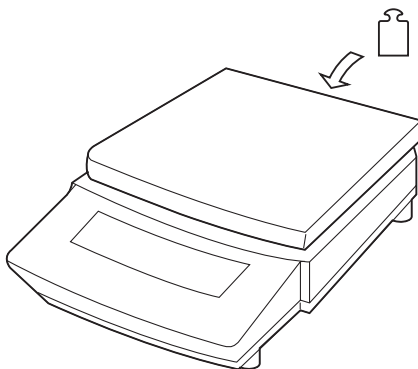

Load and unload a weight which is near the capacity of the balance five successive times.

Load : $X_1, X_2, \dots, X_i, \dots, X_5$

↑

Unload : $Y_1, Y_2, \dots, Y_i, \dots, Y_5$

↓

$$R_x = X (\text{max}) - X (\text{min})$$

$$R_y = Y (\text{max}) - Y (\text{min})$$

Cornerload Performance

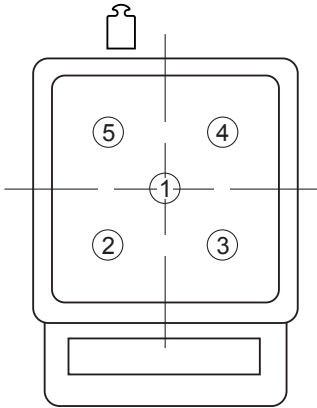

- 1** Allow the balance to warm up sufficiently by turning ON the power and leaving it at the gram-display at least two hours before starting the performance checks.
- 2** Use a weight that is approximately 1/4 of the balance capacity and place it sequentially at five different positions on the pan in the order shown. Record the readings in each of the five positions.
- 3** If the difference between the readings at the center position and each of the off-center positions (eccentric error) is within five counts, the balance cornerload performance is considered normal.

* One count corresponds to one minimum display unit of the balance model.

A-7. Below-Weigh Hook Dimensions

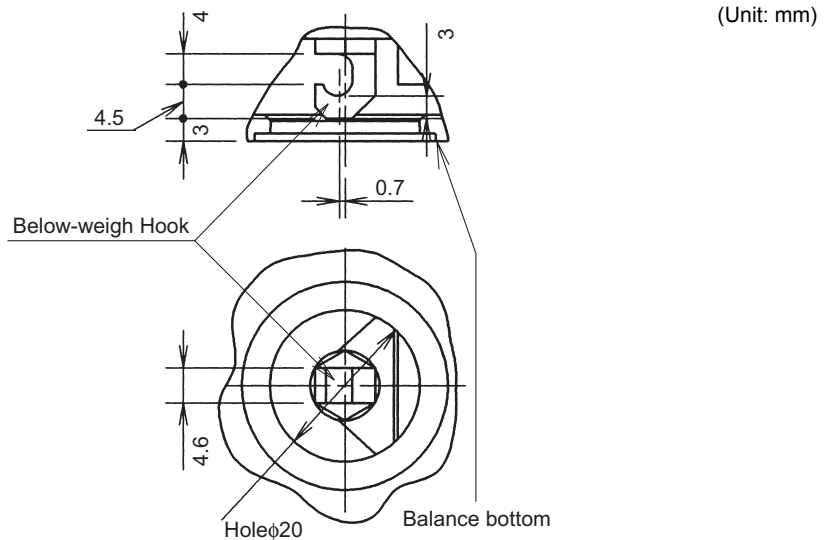

A-8. Index

A

AC adapter 8, 18, 105
 Administrator 46, 47, 48
 Air flow 8
 Ambient temperature 6
 Analog display 6, 32
 Animal weighing 76, 87
 Application keyboard 33, 73, 87, 88, 106
 Auto print 27, 59
 Auto zero 61, 87
 Automatic span calibration 45
 Averaging 49, 50

B

Bar graph display 38
 Basic operation 22
 Battery pack 18
 Baud rate 94
 Below-weigh hook 3, 66, 68, 110
 Bps 94
 Built-in calibration weight 44, 45, 47
 Built-in clock 36

C

Cable 25, 82, 90, 106
 Calibration check 39, 43, 44
 Calibration mass (→See Calibration weight)
 Calibration report 48
 Calibration weight .. 20, 39, 42, 43, 44, 45, 46, 47
 Checkweighing 55, 56, 60
 Clock 36, 45
 Clock-CAL Fully-automatic Calibration 45
 Command code 85, 86, 91
 Communication speed 94
 Comparator 56
 Computer 25, 90
 Connector 3, 107
 Continuous output 59

D

Data format 94
 Date 36, 37, 88
 Decimal point 33, 95
 Default setting 34
 Delimiter 95
 Delivery 10
 Density 65, 66, 68
 Display 5, 37, 38, 97, 98, 99
 Dosing 49

E

Echo back 86, 89
 Electronic printer 48, 81
 Environment 49
 Error code 99
 Error display 23, 53, 98
 External weight 20, 42, 43, 88

F

Filling 49
 Foot Switch 106
 Format 83, 94
 Formulation 79

G

GLP 48
 GMP 48
 Graphic display 32

H

H type 1
 Handshake 73

I

ID 48, 88
 Impact dot 106

Installation	8
Interval timer	73, 87, 88
In-use protective cover	105
ISO9000	48

K

Key	4
-----------	---

L

Large pan model	1
Last menu recall	34, 55, 65
LCD	6, 99
Limit	55, 57, 88

M

Maintenance	96, 105
Menu	30
Menu group	32
Menu item selection	30, 31
Menu lock	35, 89
Menu map	30, 31, 100
Menu reset	34, 89
Minimum display	6, 38
Multi-connection	90

N

Numerical value	33
-----------------------	----

O

Optional accessories	106
Output	48, 59, 60, 63, 86, 91, 94

P

Parity	94
Password	46, 47, 88
PCS	58, 87, 88
Peak hold	71, 87
Percentage	54
Performance check	109
Peripherals (→See Optional accessories)	
Personal computer	90

Piece counting	53, 58
Pouring mode	49
Power source	8, 18
Pretare	64, 88
Printing (→Also See "Output")	63

R

Readability (→See Minimum display)	
Remote display	106
Response	49

S

S type	1
Sensitivity adjustment (→See Span calibration)	
Small pan model	1
Span calibration 19, 20, 39, 40, 42, 44, 45, 88, 89	
Specific gravity	65, 106
Specification	6
Stability	49, 63
Stability detection band	50
Stability mark	5, 22, 52
standard accessories	105
Stand-by	5, 37
Stop bit	94

T

Target	55, 57, 88
Taring	22, 63
Time	37, 45, 88, 89
Tracking	52
Transportation	13, 96
Troubleshooting	28, 97, 99

U

Unit	4, 23, 53, 87, 88
Unit conversion	32, 87, 108
Unit weight	58, 88
Unpacking	10
User unit	53, 88

V

Vibration	8, 49, 50
-----------------	-----------

W

Weighing	22, 23
WindowsDirect	24, 95

Z

Zero range	62
Zero tracking	52

Shimadzu Corporation

SHIMADZU CORPORATION. International Business Department

3. Kanda-Nishikicho 1-chome, Chiyoda-ku, Tokyo 101-8448, Japan
Phone: 81(3)3219-5641 Fax: 81(3)3219-5710

SHIMADZU SCIENTIFIC INSTRUMENTS, INC.

7102 Riverwood Drive, Columbia, Maryland 21046, U.S.A.
Phone: 1(410)381-1227 Fax: 1(410)381-1222 Toll Free: 1(800)477-1227

SHIMADZU EUROPA GmbH

Albert-Hahn-Strasse 6-10, 47269 Duisburg, F.R. Germany
Phone: 49(203)7687-0 Fax: 49(203)7666-25

SHIMADZU (ASIA PACIFIC) PTE LTD.

79 Science Park Drive #02-01/08, CIntech IV Singapore Science Park I, Singapore 118264, Singapore
Phone: 65-6778-6280 Fax: 65-6779-2935

SHIMADZU SCIENTIFIC INSTRUMENTS (OCEANIA) PTY. LTD.

Units F, 10-16 South Street Rydalmere N.S.W. 2116, Australia
Phone: 61(2)9684-4200 Fax: 61(2)9684-4055

SHIMADZU SCIENTIFIC INSTRUMENTS (TAIWAN) CO., LTD.

11F, No. 37, Dongxing Rd., Xinyi Dist., Taipei City 11070, Taiwan
Phone: 886-2-8768-1880 Fax: 886-2-8768-1883

SHIMADZU DO BRASIL COMÉRCIO LTDA.

AV. Tambore, 576 - Tambore - Barueri, Brasil CEP 06.460-000
Phone: 55(11)2134-1677 Fax: 55(11)3611-2209

SHIMADZU (HONG KONG) LIMITED

Suite 1028 Ocean Center, Harbour City, Tsim Sha Tsui, Kowloon HONG KONG
Phone: (852)2375-4979 Fax: (852)2199-7438

SHIMADZU (CHINA) CO., LTD.

Block E, No.570 West Huaihai Road, Shanghai, 200052 P.R. of China
Phone: 86(21)2201-3888 Fax: 86(21)2201-3666

SHIMADZU MIDDLE EAST & AFRICA FZE

Warehouse No. RA08UC02, Jebel Ali, Dubai, P.O. Box 262081 United Arab Emirates
Phone: 971(4)883-6668 Fax: 971(4)883-6808

URL <http://www.shimadzu.com>