

Top-loading Balance

UPX Series

UP223X, UP423X, UP623X, UP823X, UP1023X
UP422X, UP822X
UP2202X, UP4202X, UP6202X
UP4201X, UP8201X

UPY Series

UP223Y, UP423Y, UP623Y, UP823Y, UP1023Y
UP422Y, UP822Y
UP2202Y, UP4202Y, UP6202Y
UP4201Y, UP8201Y

Instruction Manual

Read the instruction manual thoroughly before you use the product.
Keep this instruction manual for future reference.

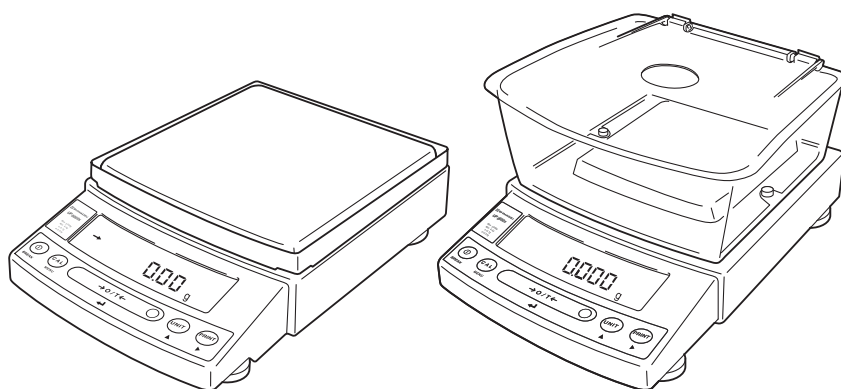

Foreword

1. Name and Function of Components

2. Installation

3. Basic Operation

4. Menu Item Selection

5. Built-in Clock Set-up

6. Display Selection

7. Calibration

8. Environment

9. Unit Display Set-up

10. Enhancing Productivity

11. Application Functions

12. Connections and Communications with External Equipment

13. Maintenance and Transportation

14. Troubleshooting

Appendices

No text

Foreword

Read the instruction manual thoroughly before using the product.

Thank you for purchasing the Shimadzu Top-loading Balance UP Series.

This instruction manual provides details on how to use the balance and on the accessories and options, etc., that are related to it. Read the manual thoroughly and make sure it is used in accordance with the details listed herein. The following instruction manual is also supplied with this product.

Simple Sheet: Operation Guide 321-78282 Operation descriptions in a simple diagram format.

Store the instruction manuals together with the product in an easily-accessible location.

The instruction manuals (PDF format) can also be downloaded from the Shimadzu website

(<https://www.an.shimadzu.co.jp/balance/>)  Click

Notices

- If the balance is to be operated by a different user or transferred to a different location, make sure the instruction manuals are also provided to the subsequent users.
- Contact the Shimadzu sales office or agency in the event of the instruction manuals were lost or mislaid.
- Safety precautions are listed in the instruction manual to ensure safe usage. Read the section on [Safety Precautions] thoroughly prior to using the balance.
- You are requested to complete the user registration procedure to ensure that your balance can be used without anxiety. This is required when making claims against the product warranty, and you are requested to complete either of the following two user registration procedures.
 - (1) Fill in the details on the rear of the [Product Warranty] card provided, and send it to us by facsimile.
 - (2) Access our website and fill in the details accordingly.
(<https://www.an.shimadzu.co.jp/balance/user/index.html>)

Once you have completed the user registration procedures, you will be given precedence with regard to receiving information on product warranty and Shimadzu products and services. (You are also requested to fill in the questionnaire.)





Notices



- The content of this manual is subject, without notice, to modifications for the sake of improvement.
- Every effort has been made to ensure that the content of this manual was correct at the time of creation. However, in the event that any mistakes or omissions are discovered, it may not be possible to correct them immediately.
- The copyright of this manual is owned by Shimadzu Corporation. Reproduction and duplication of whole or part of the content without permission of the company are strictly prohibited.
- Windows is the registered trademark of Microsoft Corporation of the U.S.A. in the United States and other countries. All other company names and product names that appear in this manual are trademarks or registered trademarks of the companies concerned. Note that TM and ® indications are not used.
- UniBloc and Smart+ are the registered trademarks of Shimadzu Corporation in Japan.
- Shimadzu does not guarantee that the serial communication functions will operate without problem on all PCs. Shimadzu will not accept responsibility for any trouble that arises as a result of using this function. It is recommended that all important data and programs are backed up in advance.

Notation Conventions Used within the Instruction Manual

The instruction manual uses the following notation conventions in accordance with the degree of risk and damage to equipment.

Notation	Description
 Caution	Indicates a potentially hazardous situation which, if not avoided, may result in minor to moderate injury or equipment damage.
 Note	Provides additional information needed to properly use the balance.

Descriptions of the other pictograms used within the instruction manual are listed below.

Pictogram	Description
 Prohibitions	Indicates an action that must NOT be performed
 Instructions	Indicates an action that must be performed.

The functions available for use and the selectable items differ in accordance with the model with the UP Series. Read the sections concerning the model in use.

Other conventions used in this manual include:

1, 2, 3, ...	Indicates the step number in a procedure
[POWER] key	Indicates the operation key on the balance.
[E-CAL] etc...	Items displayed on the balance display are shown in [] brackets. This also includes displayed items when selecting a menu item and is also used to identify menu items.
mass display	Indicates that the balance is in the weighing mode and mass is displayed in one of the weighing units.
Mass display	Indicates that the balance display is in one of the mass units and that the value displayed will change according to the load on the pan.
	Indicates the menu item to be selected. In the number of the menu item on the Menu Map. See A-2 "Menu Map".

UP Series

The UP Series comprises of the Top-loading equilibrium balances mounted with aluminum UniBloc sensors. This instruction manual provides details on operating the UP Series models listed below. The functions available differ in accordance with the model, so check the product label located on the front or back of the balance and read the sections concerning the model in use.

About the model name

Example: **UP223X**

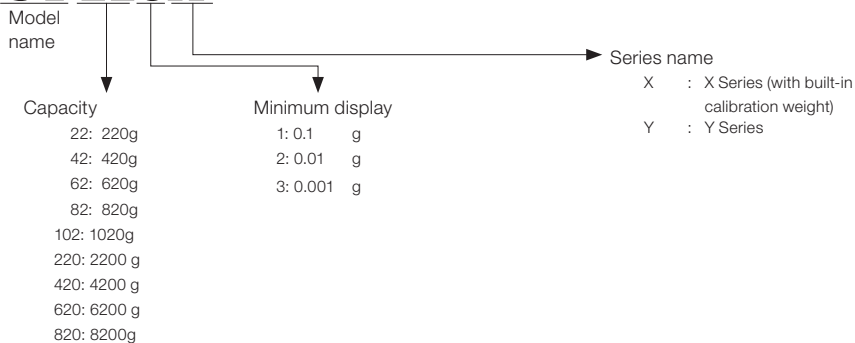

UP Lineup

UPX Series	
Small pan type	UP223X
	UP423X
	UP623X
	UP823X
	UP1023X
	UP422X
	UP822X
Large pan type	UP2202X
	UP4202X
	UP6202X
	UP4201X
	UP8201X

UPY Series	
Small pan type	UP223Y
	UP423Y
	UP623Y
	UP823Y
	UP1023Y
	UP422Y
	UP822Y
Large pan type	UP2202Y
	UP4202Y
	UP6202Y
	UP4201Y
	UP8201Y

For information on the following points, please contact your Shimadzu Balance representative.

- Product warranty
- After service

Safety Precautions

Precautions on Use

To be strictly observed

To ensure that you use the balance safely and correctly, read the following precautions carefully. The details listed below provide important information on safety, and must be observed at all times.

Precautions Related to Usage

 CAUTION



Prohibitions

Cannot be used as proof of transactions.

The balance is not permitted by law to be used as proof of transaction for drug formulation, etc.

Precautions Related to Place of Installation

 CAUTION



Prohibitions

Do not use the balance outdoors or anywhere where it will be exposed to water.

You could sustain an electric shock or the product could operate abnormally.



Prohibitions

Avoid locations where the balance will be exposed to volatile gas, flammable gas or corrosive gas.

Failure to observe this may result in the outbreak of fire and accidents.



Prohibitions

Avoid locations where the balance will be exposed to any of the following.

This could cause accidents or poor performance.

- Air flow from an air conditioner, ventilator, door or window
- Extreme temperature changes
- Vibration
- Direct sunlight
- Dust, electromagnetic waves or a magnetic field
- Condensation

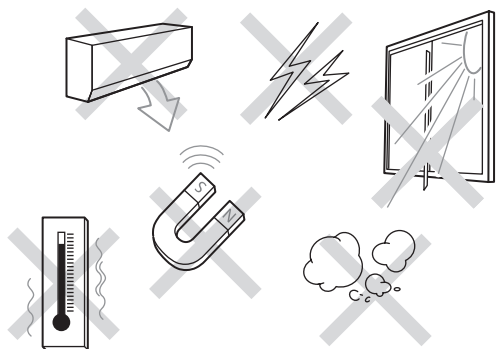

Instructions

Install the balance on a strong and stable flat table or floor.

Placing the balance in an unstable site could lead to injury or trouble with the balance. When selecting the installation site, take into account the combined weight of the balance and the item to be weighed.

Precautions Related to Installation Work

⚠ CAUTION



Prohibitions

Do not connect anything other than peripheral devices specified by Shimadzu to the balance's connector.

If you do, the balance may stop working normally. In order to avoid trouble, always connect peripheral devices in accordance with the directions in this manual.



Instructions

Use the correct power supply and voltage with the AC adapter supplied.

Using the balance with an incorrect power supply or voltage may result in the outbreak of fire or malfunctions. Note also that if the power supply or voltage is unstable or if the power supply capacity is insufficient, it will not be possible to obtain satisfactory performance from the balance.



Instructions

The included AC adapter is for use with this product only.

Do not use the included AC adapter with any other devices. Doing so could cause fires or other damage.



Instructions

Install measures to prevent the balance from toppling over in the event of earthquakes, etc.

If the balance topples over as a direct result of vibrations, it may result in injury.



Instructions

Plug the AC adapter into an easily accessible power outlet.

During emergencies, it is necessary to unplug the AC adapter from the power outlet.



Instructions

Beware of the gaps between equipment during installation.

Failure to observe this may result in fingers getting caught, leading to injury. Place fingers on the indentations on the sides of the unit and grip it firmly with both hands during installation.

Precautions Related to Work/Operations

⚠ CAUTION



Instructions

Use the correct weighing units.

Using incorrect weighing units can lead to accidents as a result of weighing errors. Check that the weighing units are correct before starting weighing.



Instructions

Treat the balance with care and respect.

The balance is a precision instrument. Subjecting it to impact may result in malfunctions. When moving the balance, remove the pan, the pan supporter the shield plate, fix the glass draft shield, the Draft shield inner plate, the Power pack, the Stage, the Shield case and the Multi-stand, etc in place, and grasp it firmly with both hands when carrying it. If the balance is to be stored for long periods of time, place it in the packaging box which was used for delivery and store it in a safe location with few temperature fluctuations.

Risks Involved in Repairs/Dismantling/Modifications

⚠ CAUTION



Prohibitions

Never disassemble, modify or attempt to repair this product or any accessory.

You could sustain an electric shock or the product could operate abnormally. If you believe that the balance has failed, contact your Shimadzu representative.

Precautions Related to Inspections/Maintenance

CAUTION



Prohibitions

The design standard period of usage for this product is ten years. Using the product for more than the design standard period may result in it being impossible to maintain performance or malfunctions, etc.

- A fee is charged for safety inspections. Direct all requests to our sales offices, dealers or the service agencies specified by the company.
- The design standard period is the standard period during which the product can be used safely without malfunctions, and it does not represent the valid period of product warranty.
- See [Chapter 13. Maintenance and Transportation] for details on daily maintenance inspections and replacement parts.



Instructions

Unplug the power cord from the AC adapter during inspections, maintenance and when replacing parts.

Failure to observe this may result in accidents caused by electric shocks or short-circuits.



Instructions

Always use the parts specified in the instruction manual when replacing parts.

The use of non-specified parts may result in them becoming damaged and unusable.

Measures to be Observed during Emergencies

CAUTION



Instructions

If you detect anything abnormal (e.g. a burning smell), immediately disconnect the AC adapter from the power outlet.

Continuing to use the balance with an abnormality could lead to fire or an electric shock.

Measures to be Observed during Power Outages

CAUTION



Instructions

After a power outage, turn the power back ON.

When a power outage occurs, the power is shut off automatically. Therefore, begin operation from "Turning on the Power" (P.15) again.

Caution Labels

Cautions labels are placed in necessary locations on the balance to ensure that it is used correctly. In the event of these labels being mislaid or damaged, contact a Shimadzu sales office or service agency to request new labels, and then make sure they are situated in the correct locations.

[UP223X example]

Use the AC adapter supplied with the specified power supply

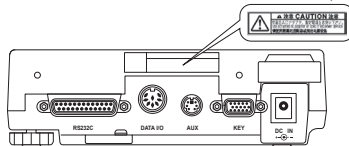

Residual Risk Information

Residual risk refers to the risks that could not be removed or reduced during the design and manufacturing stages. Check the [Residual Risk Maps] for each area with inherent risks and implement protective measures while referring to the [List of Residual Risks].

Residual Risk Maps

The [Equipment Location] and [No.] shown below match up with the [List of Residual Risks]. Refer to the [List of Residual Risks] for further details.

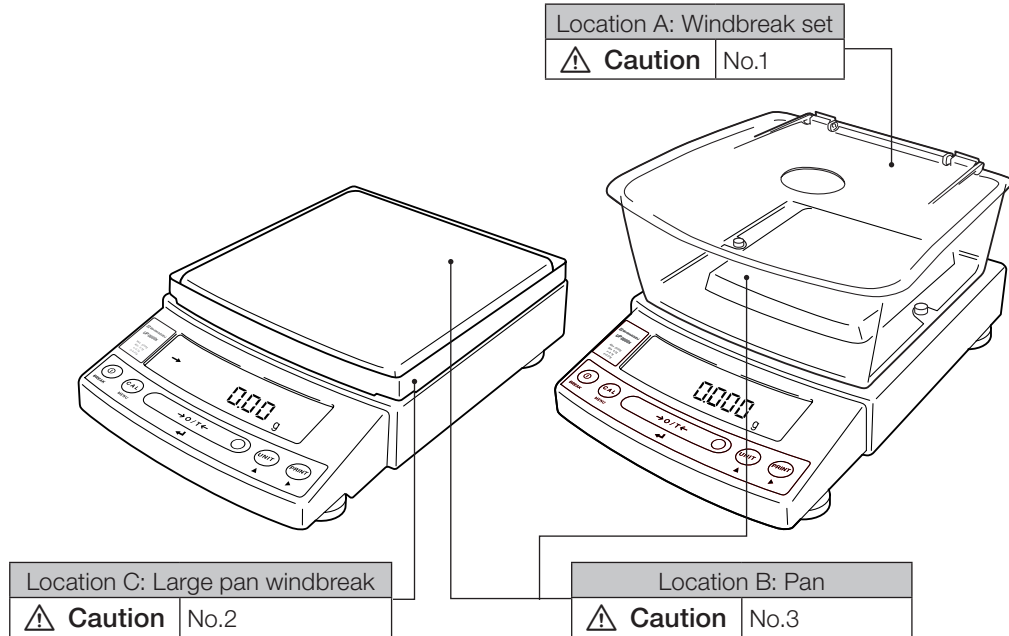

List of Residual Risks

The [No.] and [Equipment Location] shown below match up with the [Residual Risk Maps]. Check the [Residual List Maps] for further retains on the relevant [Equipment Location]. Read and fully comprehend the details listed in [Refer To] and implement protective measures without fail.

Measurement Preparations

No.	Equipment Location	Risk	Protective Measures Implemented by Users	—	—
1	A	⚠ Caution If you attempt to move the balance while holding the windbreak set, the windbreak will detach from the balance.	When moving the balance, do not hold the windbreak set, instead securely hold the main body from the bottom using both hands.	Refer To	P10
				Task	Moving the Balance
				Qualifications & Training	Recipients of Work Training
2	C	⚠ Caution When setting the large pan windbreak, holding it by the corners could cause you to cut your hands.	When installing the windbreak, do not hold it by sharp edges when placing.	Refer To	P12
				Task	Windbreak installation
				Qualifications & Training	Recipients of Work Training

Maintenance

No.	Equipment Location	Risk	Protective Measures Implemented by Users	—	—
3	A	⚠ Caution Transporting the balance with the pan and pan supporter installed could result in damage to the main body.	Always remove the pan and pan supporter when transporting the balance for repair.	Refer To	P10
				Task	Transporting during repairs
				Qualifications & Training	Recipients of Work Training

Product Warranty

Shimadzu provides warranty with regard to the following as a basic principle. See the [Product Warranty] supplied for further details.

1. Period of Warranty

Valid for one year from the date of purchase. (Restricted to Japan).

2. Items Covered by the Warranty

Malfunctions attributable to Shimadzu occurring within the period of warranty will be repaired or parts replaced free of charge. (The warranty is only valid within Japan).

3. Limitation of Liability

- 1) Shimadzu cannot be held responsible for the users' loss of profit, indirect damages or secondary damages under any circumstances. The company can also not be held responsible for damages relating to damage compensation caused to users by third parties.
- 2) The liability for compensatory damages attributable to Shimadzu is limited to a sum equivalent to the cost of the product in all cases.

4. Warranty Exemption

The warranty is not valid for malfunctions attributable to the following, even during the period of warranty.

- 1) Malfunctions occurring as a result of misuse.
- 2) When the product is repaired or modified, etc., by any company or person other than Shimadzu Corporation.
- 3) Malfunctions attributable to causes other than the product itself.
- 4) When used in harsh environments, such as high-temperature and high-humidity environments, environments subject to corrosive gases, and environments subject to vibrations, etc.
- 5) Malfunctions caused by fire, earthquakes or other natural disasters, by contamination caused by radioactivity or toxic substances, or by unavoidable situations, such as war, civil unrest and crime.
- 6) When moved or transported elsewhere after having been installed.
- 7) Consumable parts and parts conforming to this designation.

Aftercare Services and Part Supply Period

1. Aftercare Service

In the event of the product not operating normally, carry out inspections and resolve the problem in accordance with the instructions providing in [14.Errors and Recovery] (P.91). If the problem persists or other problems that are thought to be malfunctions not covered by the instructions provided arise, contact the numbers provided on the back cover.

2. Part Supply Period

The period during which replacement parts will be supply for the product is up until seven years after the termination of manufacture.

Note that there are cases in which it will not be possible to supply replacement parts once this supply period has elapsed. However, the supply periods stipulated separately by the manufacturers will be applied for parts not manufactured by Shimadzu.

Inspections and Maintenance

Daily inspections, Periodic inspections and regular calibrations are required to ensure that the performance of the balance is maintained for long periods of time so that correct measurement data can be acquired.

- See [Chapter 13. Maintenance/Inspections] for details on daily inspections and part replacement.
- Contact a Shimadzu sales office or service agency, or one of Shimadzu's service companies to request Periodic inspections and regular calibrations.

Product Disposal

When disposing of the product, dismantle and dispose of the parts separately in accordance with their composition in order in consideration of environmental conservation.

Direct all inquiries to the contact numbers provided on the back cover.

Shimadzu Balances and 21 CFR Part 11

21 CFR Part 11

21 CFR Part 11, Electronic Records, Electronic Signatures, Final Rule (often referred to as Part 11) is the United States Food and Drug Administration (FDA) regulation affecting computer resources and electronic records that are used for any document that is required to be kept and maintained by FDA regulations. Requirements concerning computer resources security are key elements in Part 11. The controls implemented as a result of security related requirements are intended to result in trusted records.

Shimadzu Lab Solutions Balance

Shimadzu provides a means for compliance with 21 CFR Part 11 with Shimadzu Lab Solutions Balance software, part of a comprehensive laboratory data management system, Shimadzu Lab Solutions. Ask your Shimadzu representative about it.

Two-way Communication

Shimadzu balances have always been computer friendly and they can be set up for bi-directional communication as part of a fully automated production system or LIMS. This manual includes the command codes and information needed by programmers to integrate Shimadzu balances with their software.

Action for Environment (WEEE)

To all user of Shimadzu equipment in the European Union:

Equipment marked with this symbol indicates that it was sold on or after 13th August 2005, which means it should not be disposed of with general household waste. Note that our equipment is for industrial/professional use only.

Contact Shimadzu service representative when the equipment has reached the end of its life.

They will advise you regarding the equipment take-back.

With your co-operation we are aiming to reduce contamination from waste electronic and electrical equipment and preserve natural resource through re-use and recycling.

Do not hesitate to ask Shimadzu service representative, if you require further information.

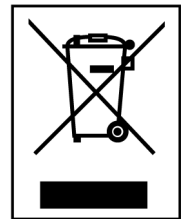

WEEE Mark

For California, USA Only

This product contains a battery that contains perchlorate material. Perchlorate Material - special handling may apply. See www.dtsc.ca.gov/hazardouswaste/perchlorate

Table of Contents

Foreword.....	I	4.3	Menu Item Selection Procedure.....	22
UP Series	III	4.4	Setting Numeric Values.....	25
Safety Precautions.....	IV	4.5	Related Useful Functions	26
Precautions on Use	IV	4.5.1	Last Menu Recall.....	26
■ Precautions Related to Usage.....	IV	4.5.2	Returning to the Default Settings (menu reset)	26
■ Precautions Related to Place of Installation.....	IV	4.5.3	Menu Lock	27
■ Precautions Related to Installation Work	V	5.	Built-in Clock Set-up.....	28
■ Precautions Related to Work/Operations.....	V	5.1	Date	28
■ Risks Involved in Repairs/Dismantling/ Modifications	V	5.2	Date Output Style	28
■ Precautions Related to Inspections/ Maintenance	VI	5.3	Time.....	29
■ Measures to be Observed during Emergencies	VI	5.4	Setting Display During Stand-by	29
■ Measures to be Observed during Power Outages	VI	6.	Display Selection	30
■ Caution Labels	VI	6.1	Bar graph display.....	30
■ Residual Risk Information.....	VII	6.2	Changing the Minimum Display Digit	30
Aftercare Services and Part Supply Period.....	IX	7.	Calibration	31
Inspections and Maintenance.....	IX	7.1	What is calibration?	31
Product Disposal	IX	7.2	Calibration Execution	32
Shimadzu Balances and 21 CFR Part 11	X	7.2.1	Span Calibration Using the Built-in Weight (UPX Series Only)	32
Action for Environment (WEEE).....	X	7.2.2	Calibration Check Using the Built- in Weight (UPX Series Only).....	33
Table of Contents	XI	7.2.3	Span Calibration Using External Weights	35
1. Name and Function of Components..	1	7.2.4	Calibration Check Using External Weights	36
1.1 Components.....	1	7.3	Calibration Setting.....	37
1.2 Key Panel and Operation	3	7.3.1	Selecting the Calibration Type... 37	
1.3 Balance Display and Function.....	4	7.3.2	PSC Fully-automatic Calibration (UPX Series only).....	37
2. Installation	5	7.3.3	Clock-CAL Fully-automatic Calibration (UPX Series only)	39
2.1 Choosing the Installation Site.....	5	7.3.4	PCAL: Calibration of the Built-in Weight (UPX Series only).....	40
2.2 Unpacking and Delivery Inspection.....	7	7.3.5	PCAL Password Setting (UPX Series only).....	41
2.3 Installation.....	10	7.4	Maintaining Calibration Reports... GLP/ GMP/ISO Compliant Measurement Management Systems	42
2.4 Turning on the Power	15	7.4.1	Calibration Report Setting.....	42
2.5 Span Calibration	16	7.4.2	Balance ID Setting.....	42
3. Basic Operation The balance can be used correctly according to the content of Chapters 1 to 4.....	19	8.	Environment	43
3.1 Weighing.....	19	8.1	Overview	43
3.2 Changing the Unit Display.....	20	8.2	Stability and Response (Averaging).....	43
4. Menu Item Selection (Read Chapters 4 to 12 before using the balance).....	21	8.3	Stability Detection and Settings	45
4.1 What is the Menu?	21	8.3.1	Stability Detection Band.....	45
4.2 Menu Map.....	21			

Table of Contents

8.3.2	Timing of Stability Mark Illumination and Data Output.....	46	12.5.3	Format.....	88
8.4	Tracking	46	12.5.4	Communication Speed	88
9.	Unit Display Set-up.....	47	12.5.5	Parity / Bit Length	88
9.1	Units.....	47	12.5.6	Stop Bit	89
9.2	Percentage (%) Conversion.....	48	12.5.7	Delimiter	89
10.	Enhancing Productivity	49	12.6	Decimal Point Symbol in Output Data....	89
10.1	Checkweighing and Target Display	49	13.	Maintenance and Transportation.....	90
10.1.1	Checkweighing (Comparator) Display Type 1	50	13.1	Maintenance	90
10.1.2	Checkweighing (Comparator) Display Type 2	50	13.2	Moving the Balance	90
10.1.3	Target Mode.....	51	14.	Troubleshooting	91
10.2	Piece Counting (PCS).....	52	14.1	General Display.....	91
10.3	Automatic Printing and Output (Auto Print)	53	14.2	Error Display	92
10.4	Automatic Compensation of Zero Point Drift (Auto Zero).....	55	14.3	Troubleshooting	93
10.5	Sample Loading and Unloading Determination (Zero Range)	56	14.4	LCD (Liquid Crystal Display) Check.....	93
10.6	Taring/Printing at Stability	57	Appendices	94	
10.7	Registering Container Weight (Pretaring Value)	58	A-1.	Specifications	94
11.	Application Functions.....	59	A-2.	Menu Map.....	96
11.1	Solid Specific Gravity Measurement	59	A-3.	Standard Accessories and Maintenance Parts List.....	101
11.2	Liquid Density Measurement	62	A-4.	Optional Accessories List.....	102
11.3	Detecting Peak Values (Peak Hold)	65	A-5.	RS-232C/Specifications of Connectors	103
11.4	Outputting at Fixed Times (Interval Timer)	67	A-6.	Unit Conversion Coefficient List.....	104
11.5	Measuring a Large Number of Small Samples (Add-on Mode)	68	A-7.	Performance Checks	105
11.6	Animal Weighing mode	70	A-8.	Below-Weigh Hook Dimensions.....	106
11.7	Formulation Mode.....	73	A-9.	Index	107
12.	Connections and Communications with External Equipment	75			
12.1	Connecting Printers	75			
12.2	Connecting Personal Computers.....	76			
12.3	Connecting PLCs and Other Serial Communications Equipment.....	78			
12.4	Cable Connections (RS232C)	79			
12.4.1	Connecting the Cable	79			
12.4.2	Data Format	80			
12.4.3	Using Command Codes.....	82			
12.5	Communication Setting	87			
12.5.1	Overview	87			
12.5.2	Handshaking	87			

1. Name and Function of Components

1.1 Components

a. Large pan model

Label

Shows model name. "Max" and "d" are indications required by legal metrology, which do not restrict the weighing range in general use.

Operation keys

Used to tare, execute calibration and functions, program functions, input numerical values

Pan

Supports the object to be weighed

Large pan windbreak

Even light breezes can have an effect on measurements, so the windbreak protects against wind. The windbreak is not included with models with a minimum display of 0.1 g.

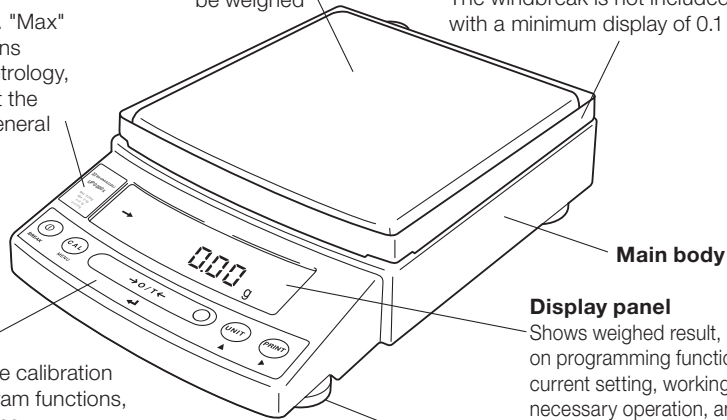

Main body

Display panel

Shows weighed result, information on programming function, indicates current setting, working function, necessary operation, and error message

Level screws

Adjust to level the balance

b. Small pan model (minimum display 0.001g, windbreak standard)

Label

Shows model name. "Max" and "d" are indications required by legal metrology, which do not restrict the weighing range in general use.

Operation keys

Used to tare, execute calibration and functions, program functions, input numerical values

Pan

Supports the object to be weighed

Windbreak set

Even light breezes can have an effect on measurements, so the windbreak protects against wind.

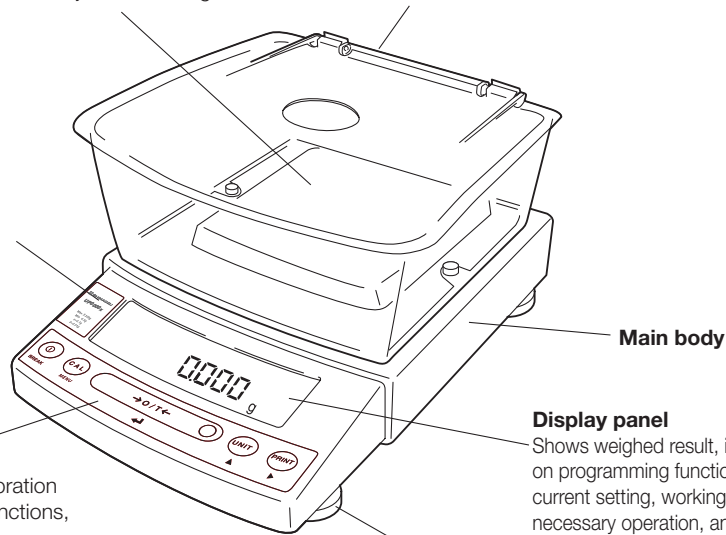

Main body

Display panel

Shows weighed result, information on programming function, indicates current setting, working function, necessary operation, and error message

Level screws

Adjust to level the balance

1. Name and Function of Components

a,b. Common

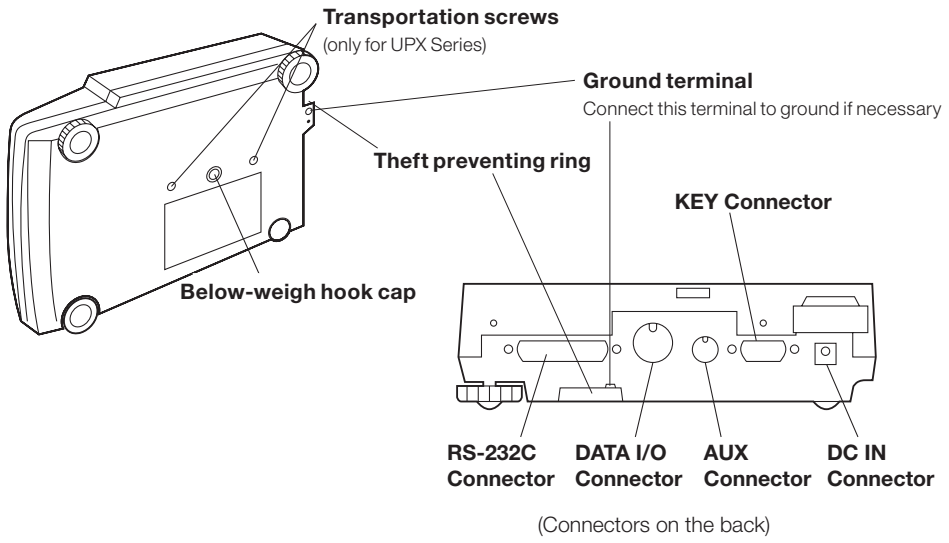

1.2 Key Panel and Operation

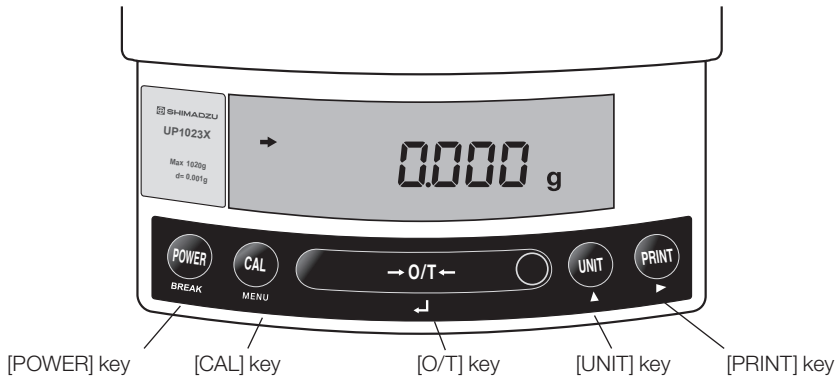

Functions of the keys

Key	During Weighing	
	Press Once and Release	Press and Hold for About 3 Seconds
[POWER]	Switches between the operation and standby modes.	Exits the application function and returns to the mass display.
[CAL]	Enters span calibration or menu item selection. (*1)	Displays the last menu item that was set. (Last menu recall)
[O/T]	Tares the balance. (Displays zero.) (*2)	Displays the Pretare value. (*6)
[UNIT]	Changes the weighing unit or selects the specific gravity measurement. (*3)	Switches between the 1d and 10d displays. (*4) (*7)
[PRINT]	Sends the displayed value to a peripheral device.	Sends the date and time to a peripheral device. (*6)

- *1 This key is used to set values when percent (%), number (PCS), solid specific gravity (∇ d), or liquid specific gravity (d) are displayed.
- *2 When a Pretare value is set, zero is not displayed and [-Pretare value] is displayed.
- *3 Units other than “g” must be set up before they can be used for measurement. Only gram (g), percent (%), and piece counting (PCS) are set-up before shipment.
- *4 When the unit is set to 10d, the resolution of the minimum display is decreased by one decimal place.
- *5 In Pouring mode (See 8.2), the right-most part of [O/T] key marked with a circle functions as the switch for environmental condition setting. Otherwise this part functions the same way as the other parts of [O/T] key.
- *6 Either “Taring” (at a weight exceeding 2.0% of the capacity) or “Zeroing” (at a weight within 2.0% of the capacity) takes place with a verified balance as a legal measuring instrument in using region.
- *7 Not applicable to a verified balance as a legal measuring instrument in using region.

Key	During Menu Item Selection	
	Press Once and Release	Press and Hold for About 3 Seconds
[POWER]	Returns to the previous menu level	Returns to the mass display.
[CAL]	Moves to the next menu item.	Displays the last menu item that was set. (Last Menu Recall)
[O/T]	Selects or sets the currently displayed menu item, or enter into the displayed menu.	No operation.
[UNIT]	Increases the numeric value of the blinking digit by 1.	No operation.
[PRINT]	Moves to the next digit during numeric value entry.	No operation.

1.3 Balance Display and Function

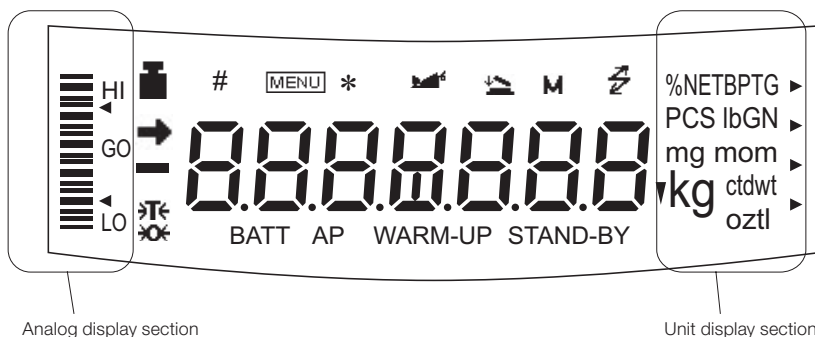

Display	Name	Description
→	Stability mark	Indicates that the weighed value is stable. (*1) In menu item selection, this symbol indicates currently selected item. (*1)
⌘	Tare symbol	Indicates that a Pretare value has been set. (*3)
■	Weight symbol	Illuminates during span calibration. Blinks before automatic span calibration starts. Note: Using a verified balance as a legal measuring instrument in using region: When PSC fully-automatic span calibration is not activated, operator must carry out span calibration with the built-in weight upon blinking of this symbol.
[]	Bracket	Note: Using a verified balance as a legal measuring instrument in using region: The figure bordered by the bracket is the auxiliary indicating device.
#	Number symbol	Indicates numeric value entry.
MENU	Menu symbol	Illuminates during menu item selection.
*	Asterisk	Indicates that the displayed numeric value is not a mass value. (*2)
↔	Communication symbol	Illuminates during communication to external equipment through the RS-232C or DATA I/O connector.
▼	Inverse triangle symbol	Indicates the set-up of solid specific gravity measurement. Used as a substitution of the decimal point.
⊗	Zero symbol	Indicates the set-up of Auto Zero function.(*3) Note: Using a verified balance as a legal measuring instrument in using region: Indicates that the balance is set exactly to "Zero" with the zero-setting function(+/- 0.20e: e = verification scale interval).
🐾	Animal symbol	Indicates the set-up of Animal Weighing function.(*3)
🏗️	Add-on symbol	Indicates the set-up of Add-on mode or Formulation mode.
M	Memory symbol	Displays when the net total mass measurement function (memory function) is ON.
AP	Auto Print symbol	Indicates the set-up of Auto Print function.
STAND-BY	Stand-by symbol	Illuminates when the balance power is in the standby mode. Also illuminates when the application function has entered the standby mode.
▶	Response stability setting symbol	Displays to indicate response stability setting status.

*1 Stability mark

The displayed value may change while the stability symbol remains illuminated if the load is changing slowly or if the stability detection band has been set to a large value.

*2 Decimal replacement

If there are any decimals to the right of 7 digit numbers, this will be displayed to indicate the presence of the decimals that are not displayed.

*3 Not applicable to a verified balance as a legal measuring instrument in using region

2. Installation

2.1 Choosing the Installation Site

(1) Power supply

Select an installation site with a power source that allows for proper use of the included AC adapter. Verify that the supply power voltage conforms to that indicated on the AC adapter.

(2) Installation site

2

 **Caution**

Avoid sites where the balance will be exposed to the following:

- Air flow from air-conditioner, open window, or ventilator

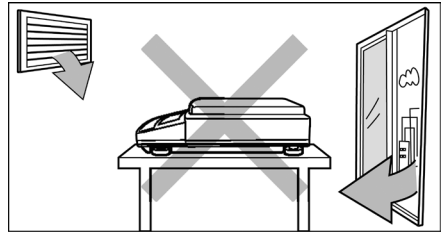

- Vibration

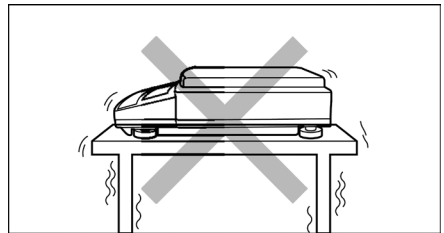

- Direct sunlight

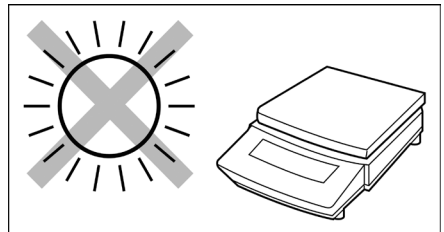

Continued

2. Installation

- Extreme temperature, temperature changes or humidity

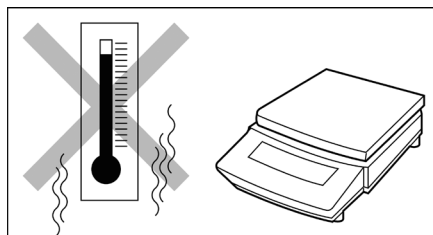

- Corrosive or flammable gasses
- Dust, wind, electromagnetic waves, or magnetic fields

Install the balance on a strong and stable flat table or floor in the room.

Large capacity balances should be installed on a sturdy floor and table that can support the total load of the balance and object to be weighed.

2.2 Unpacking and Delivery Inspection

Unpack and remove all the items from the delivery box. Check if all the listed items are present and nothing has been damaged. Contact your local distributor in case of damaged or missing items. Contact information is provided on Last page.

1 Standard packed item and quantity

2

Type	a. Large pan model		b. Small pan model	
	Minimum display d=0.1g	Minimum display d=0.01g	Minimum display d=0.01g	Minimum display d=0.001g
Model	UP4201X UP8201X	UP2202X UP4202X UP6202X	UP422X UP822X	UP223X UP423X UP623X UP823X UP1023X
	UP4201Y UP8201Y	UP2202Y UP4202Y UP6202Y	UP422Y UP822Y	UP223Y UP423Y UP623Y UP823Y UP1023Y
Balance main body	1	1	1	1
Pan supporter cap	4	4	4	4
Pan	1	1	1	1
AC adapter	1	1	1	1
In-use protective cover	1	1	1	1
Windbreak (for Large pan)	0	1	0	0
Windbreak set (for Small pan)	Main	0	0	1
	Lid	0	0	1
	Fixing knob	0	0	2
Rubber cap	0	0	2 (installed on balance main body)	2 (installed on balance main body)
Stainless screw	0	0	2*	2*
Instruction manual (incl. operation explanation sheet)	1	1	1	1

* In cases where there is any risk of organic solvents coming into contact with the main body, pull off the 2 rubber caps from the top of the main body and fasten the included stainless steel screws in the holes.

a. Large pan model

■ Pan

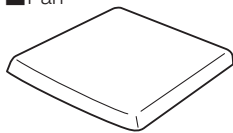

■ Large pan windbreak
(0.01 g models only)

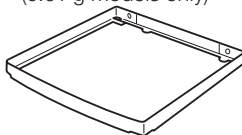

■ Operation explanation sheet

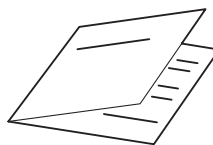

■ Pan supporter caps

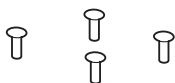

■ In-use protective cover

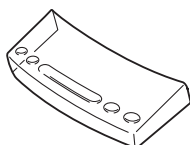

■ Instruction manual

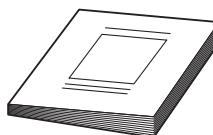

■ Balance main body

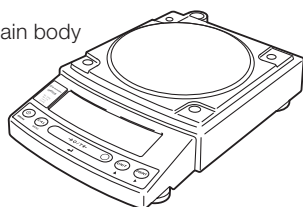

■ AC adapter
(The shape of the adapter supplied with
the balance may differ from this figure.)



■ Screw Driver

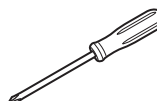

b. Small pan model

- Windbreak Lid
(minimum display 0.001g models only)



- Windbreak Main
(minimum display 0.001g models only)

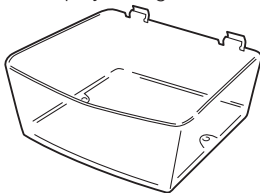

- Pan

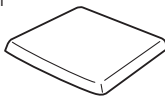

- operation explanation sheet

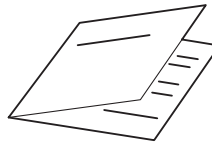

- Pan supporter caps



- In-use protective cover

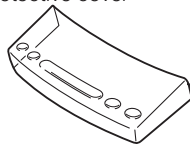

- Instruction manual

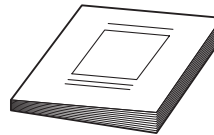

- Balance main body

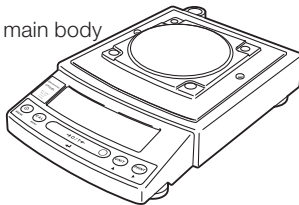

- AC adapter
(The shape of the adapter supplied with the balance may differ from this figure.)



- Fixing knobs for windbreak
(minimum display 0.001g models only)



- Stainless screws



- Screw Driver

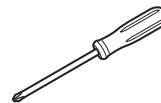

2.3 Installation

Start at step **3** when installing a UPY Series balance. Prepare a plus (+) screw driver for a UPX Series balance.

- 1** Place the balance main body upside down. (UPX only)

 **Caution**

Do not operate step **2** with the balance placed on its side. Place the balance on a smooth surface.

- 2** Referring to the explanation label on the bottom of the balance, turn the two transportation screws **counterclockwise until they tighten again**. (UPY only)

 **Caution**

When moving the balance again, turn the two transportation screws clockwise until they tighten. (UPX only)

- 3** Slowly and carefully turn the main body back over (right side up).

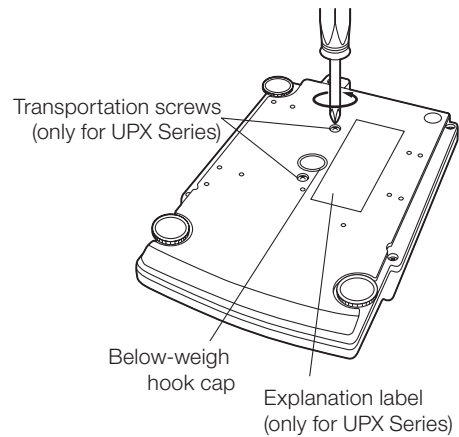

4 This balance has three level screws (adjustable feet) at the right front, left front and right rear corners.

Turning a level screw clock-wise stretches the leg to raise the balance body there. Turning anticlockwise withdraws the leg and lowers the balance body.

The level indicator locates at left rear. The bubble of it is off center when the balance is not placed level.

- (1) At first, adjust only with the two front screws. Then, turn the right rear level screw ① anticlockwise to withdraw its leg completely.

While adjusting level screws and observing the bubble, gently press the left front corner of the balance ② so that both front level screw feet ③ are touching the table surface.

- (2) Bubble moves to the highest position. Therefore, adjust level screws ③ so that the balance main body is lowered in the direction of the bubble.

Case 1: Right front of the balance is too high.
Turn right front level screw anti-clockwise so that the bubble moves towards center.

Case 2: Front of the balance is too low. Turn both front level screws clockwise so that the bubble moves towards center.

- (3) When the bubble has come to the center of the red circle, turn the right rear level screw clockwise until its foot softly touches the table surface. Verify the balance sits stable with four feet.

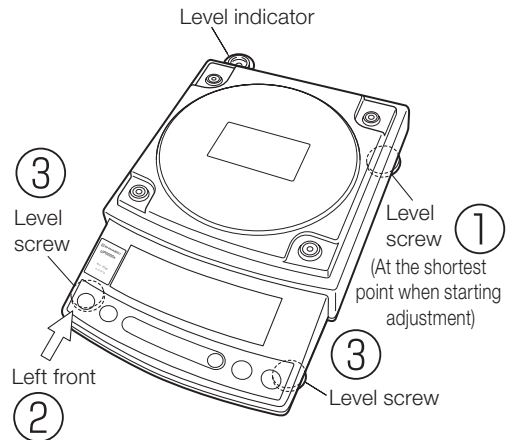

[Large pan model]

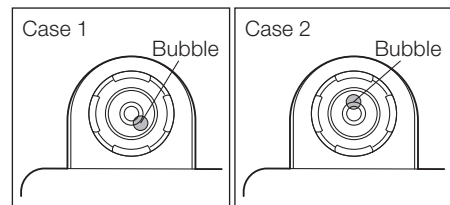

2. Installation

- 5** Install the pan. With small pan model with minimum display of 0.001g, the standard windbreak is also installed here.

a. Large pan model

- (1) Insert the four pan supporter caps into the holes in the top of the balance.
- (2) Next, align the large pan windbreak with the frame and set in place
- (3) Lastly, set the pan so that the positioners on the back of the pan precisely align with the pan supporter caps as shown in the figure.

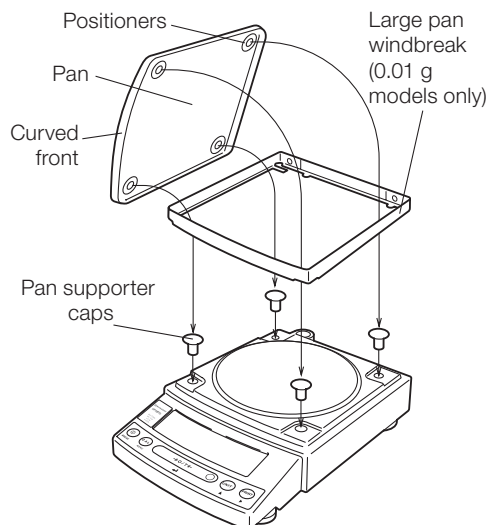

b. Small pan model (minimum display 0.01g · No windbreak)

Insert the four pan supporter caps into the holes in the top of the balance. Place the pan gently on pan supporter caps. Positioners of the pan must fit pan supporter.

The rubber caps on top of the main body may be replaced with the stainless screws so that it will be more secure when exposed to organic solvent.

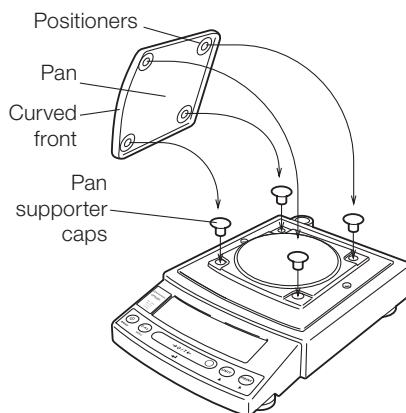

b. Small pan model (minimum display 0.001g, windbreak standard)

- (1) Pull out the two rubber caps from the main body top.

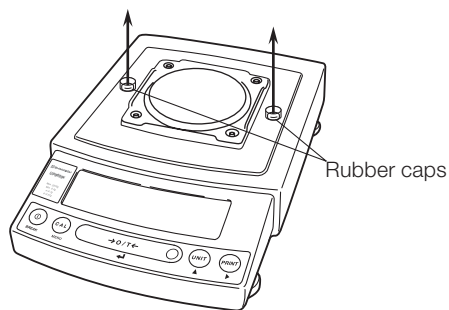

- (2) Fit windbreak main on top of the balance main body, and fasten it with two fixing knobs. In cases where there is any risk of organic solvents coming into contact with the main body, use the included stainless steel screws to fasten the windbreak instead of the fixing knobs.

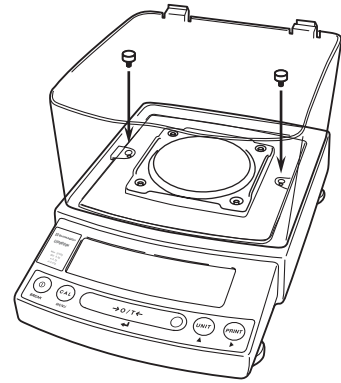

- (3) Insert the four pan supporter caps into the holes in the top of the balance. Place the pan on them. Positioners on the pan must fit pan supporter caps.

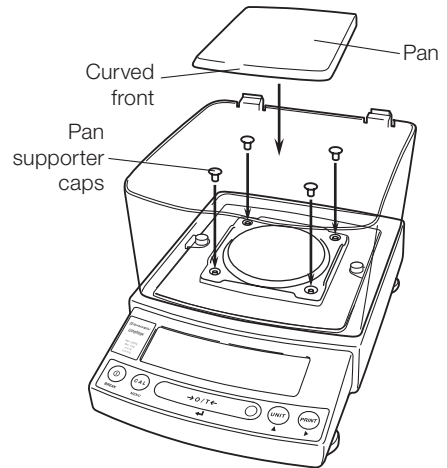

- (4) Place windbreak lid on top of windbreak main fitting the hinge parts.

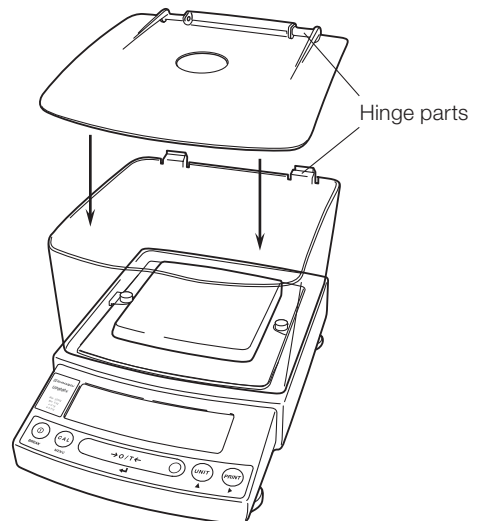

2. Installation

- 6** If you use in-use protective cover, peel off the paper to expose the adhesive on it, then fit it on the display and key part. Press the adhesive parts gently.

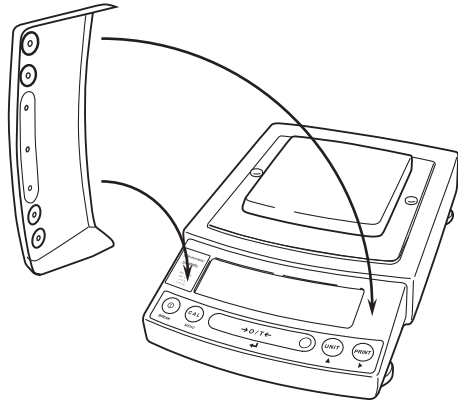

Note

Using a verified balance as a legal measuring instrument in using region:

Legal regulations require a verified balance be sealed. This control seal is a self-destructive adhesive label. This seal is irreparably damaged invalidating the verification, if you attempt to remove it. The balance must then be re-verified before it is used for legal measurements.

2.4 Turning on the Power

- 1** Insert the AC adapter plug into the DC IN connector on the back of the balance.
- 2** Insert the AC adapter into the power source. The balance self-check is activated and the following messages are displayed in the order indicated.
First, the software version number is displayed.
(Balance self-check display)
[5.00:00]→[CHE 5]→[CHE 4]→
[CHE 3]
→[CHE 2]→[CHE 1]→[CHE 0]→ prompting all
the symbols and segments →[OFF]

* e.g. of the version number

(([CHE 5] and [CHE 4] are not displayed for the
UPY Series)

- 3** Press [POWER] key.
All the symbols and segments prompt and then
the display changes to indicate the gram-display.
The backlight is illuminated.

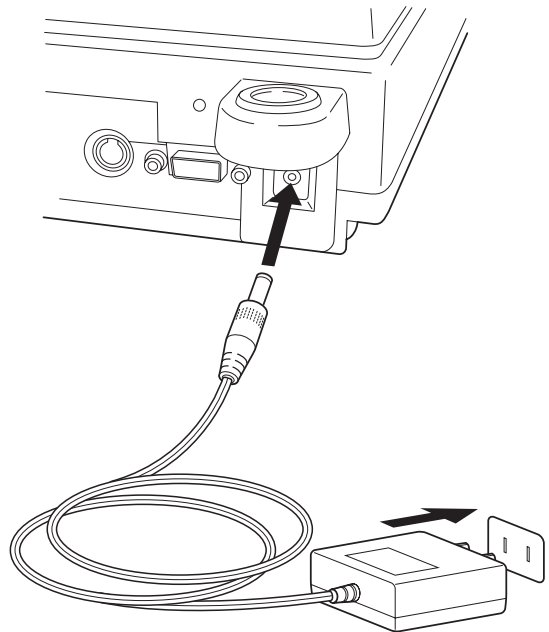

Note

If display all mode (→14.4) is selected, the balance will stop in the display all state.

Press the [O/T] key afterwards to switch to g display.

* The actual AC adapter shape may be different.

2.5 Span Calibration



Note

Using a verified balance as a legal measuring instrument in using region:

Span calibration must be performed once the balance is installed and before using the balance as a legal measuring instrument in using region. Span calibration must be performed with the internal calibration weight to maintain the verification valid. The balance must be connected to power and warmed up for at least 2 hours prior to span calibration and use as a legal measuring instrument.

It is necessary to calibrate the balance after it is moved.

Verify that the balance is stable before performing the span calibration. To achieve a very stable state, ensure that the balance has been turned on with the gram-display for at least one hour, that the temperature is constant, that there are no breezes or vibrations and that the balance is in an area isolated from the normal traffic flow.



Note

When carrying out span calibration, it is necessary to make sure the balance is as stable as possible. In order to ensure this stability, turn the power to the g display for at least 1 hour and allow the temperature of the balance to stabilize after installation, before carrying out calibration.

UPX Series

[Span Calibration Using the Builtin Weight]

- 1 Verify that the balance is in gram-display and that the pan is empty.
- 2 Press the [CAL] key once. "i-CAL" is displayed.
- 3 Press the [O/T] key.
After [i-CAL3] ~ [i-CAL 1], [SEt], [CAL End] are displayed indicating the completion of span calibration, the gram-display will appear.

This is the standard calibration type. Refer to " 7 for Calibration".

UPY Series

[Span Calibration Using External Weights]**Note**

Not applicable to a verified balance as a legal measuring instrument in using region.

2

- 1** Verify that the balance is in gram-display and unload the sample from the pan.
- 2** Press the [CAL] key once. "E-CAL" is displayed.
- 3** Press the [O/T] key.
The value of the correct calibration weight to be loaded is displayed and blinks.

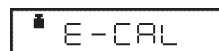

(Example)

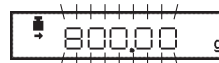
**Change the weight value to be used**

Press the [CAL] key to change the weight value. Adjust the value using the [UNIT] key and [PRINT] key then press the [O/T] key. This will set the modified weight value. Press the [POWER] key to interrupt modification.

Refer to 5.4 for numerical value input methods. The range of weights that can be used for sensitivity calibration is designated separately for each model. Refer to "External weight calibration ranges" in "A1. Specifications".

Note that attempting to input a value outside of the range will cause an error.

- 4** Load the indicated calibration weight and press the [O/T] key.

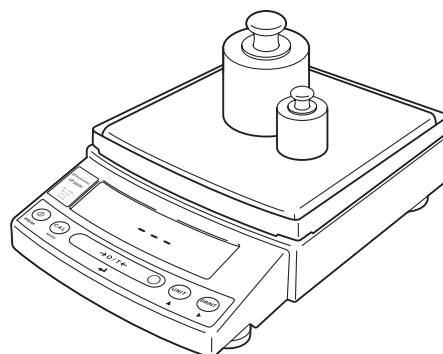

2. Installation

5 When the zero display blinks, unload the weight from the pan and press the [O/T] key.

[SEt], [CAL End] is displayed briefly to indicate completion of span calibration. Then the gram-display will return.



Note

Span calibration should be performed again : when the location of the balance is changed, when the room temperature changes considerably, periodically, according to the quality control plan of the user.

3. Basic Operation

The balance can be used correctly according to the content of Chapters 1 to 4

3.1 Weighing

- 1 If a weighing vessel (tare) is used, place it on the pan and wait for the stability mark to prompt.

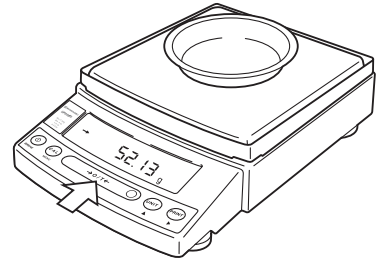

- 2 Once the display stabilizes, press the [O/T] key. This will zero the display.

The stability symbol \rightarrow will display to indicate stability.

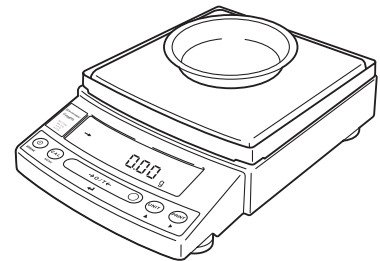

- 3 Place the object to be weighed on the pan.

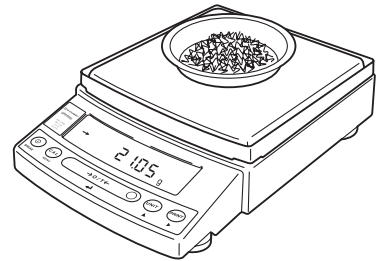

- 4 Read the displayed value after the stability mark is displayed.



Note

Using a verified balance as a legal measuring instrument in using region:

Indicates that the balance is set exactly to "Zero" with the zero-setting function (+/-0.20e; e = verification scale interval).



Note

Using a verified balance as a legal measuring instrument in using region:

The balance must be used within the temperature range indicated on the verification label.

When PSC (refer to 7.3.2), fully-automatic span calibration, is not activated, operator must carry out span calibration with the built-in weight (refer to 2.5) upon blinking of the Weight Symbol.

Error Displays During Weighing

Display	
	[oL] will be displayed if the weighing capacity or measurement ranges are exceeded.
	[-oL] will be displayed when the load on the balance is too light because the pan is misaligned or due to other causes.

3.2 Changing the Unit Display

Every time the [UNIT] key is pressed, the unit display changes sequentially among those set-up. Gram, %, and PCS have been set-up before delivery.



Notes

- Before a unit can be displayed it must be registered in "9. Unit Display Set-up".
- Unplugging then re-plugging in the AC adapter will automatically switch to g units (registration is saved).

4. Menu Item Selection (Read Chapters 4 to 12 before using the balance)

4.1 What is the Menu?

The UP Series is equipped with a number of useful functions. Menus are provided to allow customers to efficiently select the functions suited to their usage purposes and configure optimal settings. Configuration of these settings is referred to as "menu settings". Familiarize yourself with the menu setting procedures to utilize the UP Series functions. Prepare a menu map when configuring menu settings.

4.2 Menu Map

In the UP Series, menus are broadly categorized into 7 groups, and these can then be divided into further subgroups where necessary. A menu map is a diagram which illustrates the tree structure of these menus in an easy to understand manner. It is useful for allowing quick access to the menu items you wish to use. Menu maps are provided on the operation explanation sheet and in A2.

4.3 Menu Item Selection Procedure

Refer to Menu Maps (explanatory operation sheet and A2. at the end of this document).

UP Series menus are composed of 4 menu levels. Press the [CAL] key three times during mass display to open the menu. Key operations during menu usage are as shown below.

Key	Short press	Press and Hold for About 3 Seconds	Movement direction on menu map
[POWER]	Return to previous (1 step higher) menu level.	Return to mass display	←
[CAL]	Move to next menu item.	No operation	↓
[O/T]	Confirm menu or move to next menu level.	No operation	→
[UNIT]	Increases the blinking (selected) digit by +1 when setting numerical values.	No operation	
[PRINT]	Changes the blinking (selected) digit when setting numerical values.	No operation	

This instruction manual identifies each menu item by a **number**. For example, the menu items of "Stability Detection Band" of "8. Environment" are **27** through **33**. In the menu map you can see it would be entered in the order "Menu group 3 (E blinking)" → "Stable detection width".

Example: Select "Stability Detection Band" "4 counts". The menu item number is **29** on the Menu Map. The procedures are as follows.

(Menu level 1)

- 1 Press the [CAL] key repeatedly from the gram display until "SEL:EAUS" and some symbols are displayed and "E" blinks.



Note

Different operations are carried in some cases when using units other than g.
Set the display to g then press the [CAL] key.

- 2 Press the [O/T] key to select this item.
The [→] in [→E-AbtP8] will blink.



- 3 Press the [CAL] key 2 times to display the next item.
The [b] in [→E-AbtP8] will blink.



- 4 Press the [O/T] key to select this item.
The display will show [Eb-]. If [Eb-1] is selected the stability symbol will be displayed.

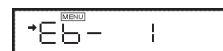

- 5** Press the [CAL] key 2 times to display the next item.
The display will show [Eb-4].

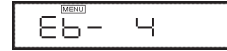

Important Note on Menu Item Selection

Even the desired menu item is reached and displayed, it is not yet set unless Stability mark (→) is prompted with it. Do not fail to press [O/T] key to put Stability mark before returning to the mass display.

- 6** Press the [O/T] key to select this item.
"SEt" is displayed and the stability mark now appears.

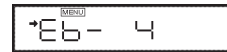

- 7** Return to the desired menu by pressing the [POWER] key.
If pressed and held, it returns to the gram-display.
Other menu items can also continue to be selected.



Menu level 1 menu groups

Menu Group	Symbol that blinks at beginning of menu	Menu Items Included
1	Symbol	Calibration
2	Graphic display	Analog display, checkweighing, and target weighing
3	E (Environment)	Installation environment and taring
4	A (Application)	Application measurements and automatic output
5	U (Unit)	Unit conversion and specific gravity measurement
6	S (System)	Clock set-up and calibration record
7	Symbol	Communication with computer and external devices.

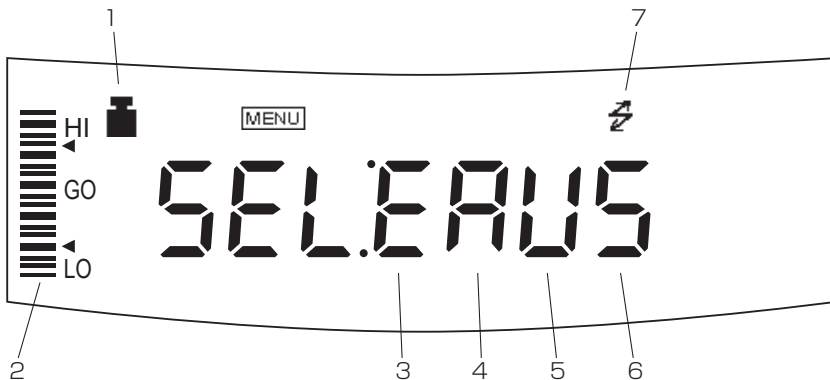

4. Menu Item Selection

Exiting from menu settings

Press and hold the [POWER] key for approximately three seconds during menu settings to return to mass display.

4.4 Setting Numeric Values

In the UP Series, various settings such as external sensitivity calibration weight value input, checkweighing for setting threshold values, and medium density during specific gravity measurement, are input as numerical values in some cases. (see 8.2, 8.3, 11.1, 11.5, 11.7 for detail of each item.)

In a menu used to set numeric values, [MENU] and [#] are both prompted and the digit to be input blinks.

Press the [PRINT] key to move the blinking digit one place to the right.

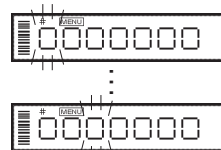

Press the [UNIT] key to increase the value of the blinking digit by one.



Press the [O/T] key to store the displayed value in the balance memory.

...“SET” is displayed when the value has been successfully saved.

...“Err” is displayed when the balance failed to save the value.



Press the [POWER] key to stop numeric entry. “Abort” is displayed briefly and the display returns to the menu, one level up.



Notes

When setting decimal points (solid specific gravity measurement, liquid specific gravity measurement, user unit multiplier settings)

1. Press the [PRINT] key repeatedly until the last digit is blinking.
The ▼ symbol or current decimal point will blink, and decimal point position setting mode will start.
2. Press the [UNIT] key.
The selected decimal point position will move to the right (equivalent to a value of $\times 10$), so continue pressing until the desired position is blinking.
3. Press the [O/T] key to set the decimal point position. “SET” is displayed briefly to indicate that the setting is completed.

Use the optional AKB-301 Application Keyboard to easily set numerical values and decimals.

4.5 Related Useful Functions

4.5.1 Last Menu Recall

This function is convenient when an application requires frequent changes to a specific menu item.

During mass display or menu selection, press and hold the [CAL] key for approximately three seconds. The last menu item that was changed or set is displayed.

4.5.2 Returning to the Default Settings (menu reset)

If you are unsure of the configured settings when using the menu, reset the menu. This will restore the menu to the default settings. Default settings are indicated on the menu map with a # symbol.

Note that PSC will be on (menu **5**) after a menu reset.

Select menu **72** to reset the menu. Use the following procedures.

- 1** In the gram-display, press the [CAL] key repeatedly until the “S” of “SEL:EAUS” blinks.
- 2** Press the [O/T] key. [S-dtSCr] =The Menu Group 6 is selected.
- 3** Press the [CAL] key until the [r] in [S-dtSCr.] is blinking.
- 4** Press the [O/T] key to display “rESEt?”
- 5** Press the [O/T] key again. “rESEt” is displayed to indicate menu reset completion.
- 6** Press the [POWER] key several times (or hold it for approximately 3 seconds) to return to the gram-display.

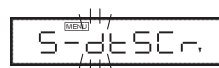

Notes

- The settings made in “12.6 Decimal Point Symbol in Output Data” and “5.2 Date Output Style” are not be cleared with Menu reset.
- Environmental setting of Pouring mode (8.2) is not cleared with Menu reset.
- Operational condition setting of Animal Weighing mode (11.6) returns to the default (Cond 1).

4.5.3 Menu Lock

In the UP Series, menu settings can be locked to prevent any accident or erroneous menu changes. This feature is called "Menu lock".

Menu Lock can be activated or released only at the "oFF" display immediately after the balance is connected to the power.

(How to lock the menu)

- 1** Disconnect power from the balance once. Then, reconnect power to the balance.

- 2** Press and hold down the [CAL] key for about three seconds during "oFF" display. "LoCKEd" is briefly displayed to indicate that the menu is locked.



Notes

- **MENU** is illuminated during "oFF" display or STAND-BY while Menu Lock is activated.
- "LoCKEd" is displayed upon an attempt of access to the menu including releasing the currently set function, while Menu Lock is activated.
- The operational condition setting for Animal Weighing (11.6) and the environmental setting for Pouring mode (8.2) are also locked under Menu Lock.
- Change of minimum display (See 6.2, 11.1, 11.2) is not locked by Menu Lock, also change of unit display (See 3.2) is not locked by Menu Lock.
- If the menu lock is enabled, the date and time printing when pressing and holding the [PRINT] key for 3 seconds, and the PRINT +, DATE=, TIME=, and TIME command operations will also be locked.

(How to remove Menu Lock)

- 1** Disconnect power from the balance once. Then, reconnect power to the balance.

- 2** When "oFF" is displayed, press and hold down the [CAL] key for about three seconds.

- 3** "rELEASE" is briefly displayed to indicate that the menu lock has been turned off.

5. Built-in Clock Set-up

The built-in clock has to be set up in advance if a calibration record is to be produced or Clock-CAL function is to be used.

5.1 Date

- 1 Select menu **63**, and set the last two digits of the year, the month, and the day, in that order. Press the [UNIT] key to increase the blinking (selected) digit by 1. Press the [PRINT] key to move the selection to the next digit to the right.

Example: June 1st, 2019, set as "19.06.01"

Example: February 29th, 2020, set as "20.02.29"

(Example)

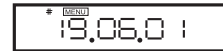

19.06.01



20.02.29

- 2 Press the [O/T] key once the date is set. This will record the set date.



Notes

The built-in clock will automatically compensate for leap years, however no checks will occur when configuring settings.

When the [O/T] key is pressed in step 2, the seconds will be set to 0, so if the date is set after the time is set, the seconds setting will be incorrect. Set the time after setting the date.

5.2 Date Output Style

When outputting the date from the balance built-in clock to an external device, the date to be output can be selected from three different styles of day, month, and year order. The order will not change when displaying the date on the balance.

To output in the YYYY-MM-DD order, select menu item **63a**. [y.m.d]

To output in the DD-MM-YYYY order, select menu item **63b**. [d.m.y]

To output in the MM-DD-YYYY order, select menu item **63c**. [m.d.y]



Notes

The setting made here on "Date Output Style" will not be cleared with Menu reset (See 4.5.2).

5.3 Time

Select menu item **64** and set the time in the 24 hour system using the [UNIT] and [PRINT] keys, then press the [O/T] key.

Example: 1:23 in the afternoon, is set as "13:23".

(Example)

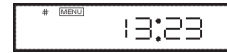

Note

The moment the [O/T] key is pressed seconds are set to 00.

5.4 Setting Display During Stand-by

Determine what is to be displayed during stand-by.

To display the time during stand-by, select menu item **65** [SS-t]

To display the date during stand-by, select menu item **66** [SS-d]

To display neither during stand-by, select menu item **67** [SS-no]

When displaying the time during power supply standby, press the [UNIT] key to display or hide the seconds.

6. Display Selection

6.1 Bar graph display

The relative amount of the load on the pan is displayed in the bar graph. This feature helps to prevent errors due to OL (overload) status. This display can not be used with the Check weighing or Target mode.

A bar displayed in the lower areas of the scale indicates that the load on the pan is small. (1)

A bar displayed up to the upper areas of the scale indicates that the load on the pan is close to the weighing capacity. (2)



Select the menu item **11** to set up Full Scale mode.
Not to display bar graph, select menu item **21**

6.2 Changing the Minimum Display Digit

It is possible to decrease the minimum balance display by one decimal place if necessary.

1 Press and hold the [UNIT] key for approximately three seconds. “- 10d -” is displayed and the display is decreased by one decimal place.

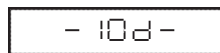

2 Press and hold the [UNIT] key for approximately three seconds. “- 1d -” is displayed and the display returns to the original number of decimal places.

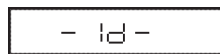

Note

The location of the decimal point in the display does not shift. In the “10d” display, the last digit is empty.

7. Calibration

7.1 What is calibration?

Calibration is required to accurately weigh items with an electronic balance accurately. Calibration should be performed:

- When the location of the balance is changed, even within the same room.
- When the room temperature changes considerably.

It is recommended that calibration be carried out every day before use.

In this instruction manual, the terms span calibration, calibration check, and calibration are used as follows.

Span Calibration: ...	Use of a reference mass (calibration weight, etc.) to calibrate the sensitivity of the balance correctly.
Calibration Check: ...	Use of a reference mass (calibration weight, etc.) to determine the amount of drift of the balance sensitivity.
Calibration: ...	Pertains to both span calibration and calibration check.

Caution

Never plug off the balance when the following messages are displayed.

[i-CAL x] [i-tESt x] [wAit] [Abort] [CAL E x] (x represents a number)

In the UPX Series, the built-in weight is not locked in this state, so if the balance is picked up or moved in this state, it could cause damage to internal mechanisms. In the event the power supply is disconnected while this indication is displayed, wait for approximately 10 seconds, then reconnect the power supply. The [CHE 4] indication time may be slightly longer than normal in these circumstances.

Notes

If the following indications are displayed, the balance has not undergone proper span calibration.

[CAL E1] When the balance will not stabilize

[CAL E2] When there is serious balance zero point drift

[CAL E4] When there is serious balance sensitivity drift

[CAL E5] When the incorrect weight is placed on the balance

7.2 Calibration Execution



Notes

- Setting before shipment is as the following:
UPX Series: Span calibration using the built-in weight ([i-CAL])
UPY Series: Span calibration using external weights ([E-CAL])
The type of calibration can be changed (See 7.3).
- Calibration will not be performed when the weight on the pan is not near zero, or the balance is not stable.

7.2.1 Span Calibration Using the Built-in Weight (UPX Series Only)

The balance is adjusted using the built-in calibration weight.

1 Verify that the balance is in mass display and that the pan is empty.

2 Press the [CAL] key once. "i-CAL" is displayed.

If this indication is not displayed, select menu

1.

Press and hold the [POWER] key for three seconds after selecting to return to the g display.

3 Press the [O/T] key

[i-CAL3] ~ [i-CAL 1], [SET], [CAL End] will be displayed in that order. Then the mass display will appear indicating the completion of span calibration.

i-CAL

i-CAL 3

⋮

CAL End

→ 0.000 g

7.2.2 Calibration Check Using the Built-in Weight (UPX Series Only)

Use of the built-in weight to check and display the degree of balance sensitivity drift.

- 1** Verify that the balance is in mass display and that the pan is empty.
- 2** Press the [CAL] key once to display “i-tEst”.
If “i-tEst” is not displayed, return to mass display and select menu item **2**.
Press and hold the [POWER] key for three seconds after selecting to return to the g display.
- 3** Press the [O/T] key.
The display changes sequentially from “i-tEst 2” to the “d xxx” display. (xxx indicates a numeric value)
This “d” value indicates the difference between the current calibration weight reading and the calibration weight reading at the last span calibration.
- 4** To perform span calibration, change the “d” value to zero, by pressing the [CAL] key.
“CALEnd” is displayed, indicating the completion of the calibration check.

Press the [O/T] key to avoid changing the “d” value to zero. (Pressing the [POWER] key interrupts calibration and does not change this value to zero.)



Note

Changing the “d” value to zero is equivalent to performing span calibration.



Note

- The [xxx] numbers displayed in the [d xxx] are the estimated value of the drift of the balance display when a weight close to the weighing capacity is placed on the balance. For example, if [d - 0.3 g] is displayed for the UP4201X (weighing capacity 4,200 g, minimum display 0.1 g), this indicates that 3,999.7 g would be displayed if a 4 kg calibration weight was placed on the balance.
- Error codes that may be displayed:
 - [d ouEr] (d OVER) indicates that the “d” value is 1000 counts or more.
 - [d UndEr] (d UNDER) indicates that the “d” value is -1000 counts or less.

7.2.3 Span Calibration Using External Weights

Not applicable to a verified balance as a legal measuring instrument in using region

The balance is adjusted using your external standard calibration weight(s).

- 1** Verify that the balance is in mass display and that the pan is empty.
- 2** Press the [CAL] key once. "E-CAL" is displayed. If "E-CAL" is not displayed, return to mass display and select menu item **3**.
- 3** Press the [O/T] key.
The value of the correct calibration weight to be loaded is displayed and blinks.

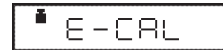

(Example)



Changing the Calibration Weight to be Used

Pressing the [CAL] key allows changes to the weight value. Modify the value using the [UNIT] key and [PRINT] key, then press the [O/T] key. Refer to 4.4 for how to make numerical input. To interrupt modification, press the [POWER] key.

Calibration range with external weights is designated to each model. Refer to "1. Specifications" for calibration range. Attempt of inputting an invalid calibration weight value causes an error message.

- 4** Load the indicated calibration weight and press the [O/T] key.
- 5** Shortly, zero display blinks. Unload the weight from the pan and press the [O/T] key.
"SEt" is displayed briefly to indicate completion of span calibration.

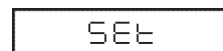

Note

OIML Class E2 or F1 calibration weight is recommended for calibration, depending on your accuracy demand.

7.2.4 Calibration Check Using External Weights

Not applicable to a verified balance as a legal measuring instrument in using region

Use of a standard calibration weight to check and display the degree of balance sensitivity drift.

- 1** Verify that the balance is in mass display and that the pan is empty.
- 2** Press the [CAL] key once to display “E-tEST”.
If “E-tEST” is not displayed, select menu item **4**.
- 3** Press the [O/T] key.
The value of the correct calibration weight to be loaded is displayed and blinks.

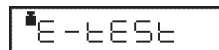

(Example)



Changing the Calibration Weight to be Used

Pressing the [CAL] key allows changes to the weight value. Modify the value using the [UNIT] key and [PRINT] key, then press the [O/T] key. Refer to 4.4 for how to make numerical input.

To interrupt modification, press the [POWER] key. Calibration range with external weights is designated to each model. Refer to “1. Specifications” for calibration range. Attempt of inputting an invalid calibration weight value causes an error message.

- 4** Load the indicated calibration weight and press the [O/T] key. The zero display blinks.
- 5** Unload the weight from the pan and press the [O/T] key.
The display changes to the “d xxx” display.
- 6** Hereafter the procedure is the same as item **4** in 7.2.2. Calibration Check Using the Built-in Weight.

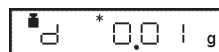
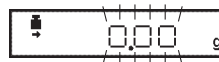

7.3 Calibration Setting

7.3.1 Selecting the Calibration Type

Set the calibration type that will be used in Calibration Execution.

To set up “Span calibration using the built-in weight”, (UPX Series only) Select menu item **1**.

To set up “Calibration check using the built-in weight”, (UPX Series only) Select menu item **2**.

To set up “Span calibration using external weights”, Select menu item **3**.

To set up “Calibration check using external weights”, Select menu item **4**.

Not applicable to a verified balance as a legal measuring instrument in using region

7.3.2 PSC Fully-automatic Calibration (UPX Series only)

The UPX Series is equipped with a function (PSC Function) which automatically carries out span calibration when the ambient temperature changes so that such changes do not impact measurement. This function can be turned ON and OFF using the following procedure.

1 To turn ON the PSC function, Select menu item **5**

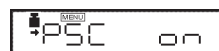

2 To turn OFF the PSC function, Select menu item **6**





Notes

- The weight symbol will blink for approximately two minutes before the automatic span calibration occurs when a temperature change is detected. If PSC starts while the balance is in use, press the [POWER] key to abort that cycle.
- The following conditions must all be satisfied for the set time in order for the PSC function to be executed. If these conditions are not satisfied within 1 minute of the specified time, automatic span calibration will not be executed and that cycle will be skipped.
 - The balance must be in mass display mode
 - If in mass display mode, the display must be within a 30 count
 - The balance must be in a stable state (the stability symbol must be displayed if in the mass display mode)
 - The load on the pan must be near zero
 - No other automatic span calibration (PSC or timer CAL) must have occurred during the same time



Note

Using a verified balance as a legal measuring instrument in using region:

When PSC, fully-automatic span calibration, is not activated, operator must carry out span calibration with the built-in weight (refer to 7.2.1) upon blinking of the Weight Symbol.

If PSC starts while the balance is in use, press the [POWER] key to abort that cycle.

7.3.3 Clock-CAL Fully-automatic Calibration (UPX Series only)

In the UPX Series, automatic span calibration of the balance can be carried out at a set time. It is possible to set up to three specific times for Clock-CAL (“tCALt1”, “tCALt2”, and “tCALt3”). Use the 24 hour system to set menu items **7**, **8** and **9**.

- Setting to “00:00” releases the function.



Notes

To execute Clock-CAL, all of the following conditions must be satisfied at the set time. If these conditions are not satisfied within one minute, the automatic span calibration is not executed and that cycle is skipped.

- There must be nothing on the pan.
- The balance must be in mass display or the standby mode.
- If in mass display mode, the display must be within a 30 count
- The balance must be stable. (The stability symbol must be illuminated during mass display.)
- Load on the pan should be near zero.
- No other automatic span calibration (PSC or timer CAL) must have occurred during the same time

Example: Setting “tCAL t1” to twelve noon.

1 Select menu item **7**



2 Set the desired time.(Refer to 4.4 for numerical input.)

(Example)



3 Press the [O/T] key. The set time will be stored.

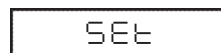

4 Proceed to next time setting by the [MENU] key, or return by the [POWER] key.



Skipping Clock-CAL

If Clock-CAL starts while the balance is in use, press the [POWER] key to abort that cycle.

7.3.4 PCAL: Calibration of the Built-in Weight (UPX Series only)

Not applicable to a verified balance as a legal measuring instrument in using region

PCAL is used to calibrate the built-in weight to a standard calibration weight that is correctly calibrated, traceable and/or certified. The administrator should set this password (refer to 7.3.5).



Notes

If this built-in weight calibration is executed when no accurate standard weight is available, span calibration and calibration checks using the built-in weight will not be able to be carried out accurately. Always use a correctly calibrated, accurate standard weight to carry out built-in weight calibration.

1 Unload the sample from the pan and verify a zero mass display.

2 Select the menu item **10** [PAS:0000] is displayed.



3 Enter the PCAL password using the [UNIT] and [PRINT] keys, then press the [O/T] key.

After "PCAL 3" is displayed, the value of the standard weight to be loaded blinks.



(Example)



Changing the Calibration Weight to be Used

Pressing the [CAL] key allows changes to the weight value. Modify the value using the [UNIT] key and [PRINT] key, then press the [O/T] key. Refer to 4.4 for how to make numerical input. To interrupt modification, press the [POWER] key. Calibration range with external weights is designated to each model. Refer to "1. Specifications" for calibration range. Attempt of inputting an invalid calibration weight value causes an error message.

4 Load the standard weight displayed, and press the [O/T] key.

Soon, zero is displayed and blinks.

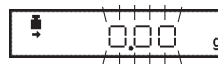

5 Unload the weight and press the [O/T] key.

The display proceeds to "PCAL 0". When the mass display appears, calibration is complete.

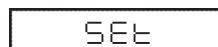



Notes

- “SEt” is displayed during the process. Leave the balance in a stable state until the mass display appears as in step 5.
- In PCAL, the value of the “weight to be loaded” cannot be changed.
- Set the PCAL password using menu item **71** (The default value is 9999.)

7.3.5 PCAL Password Setting (UPX Series only)

Not applicable to a verified balance as a legal measuring instrument in using region

This password is necessary to access the PCAL function.

It is recommended that the balance administrator set this password to prevent an unauthorized person from incorrectly calibrating the built-in calibration weight.

Select menu item **71**.

The numerical setting display appears. Enter a 4-digit number from “0000” to “9999”.

Refer to [4.4](#) for numerical input.



Note

When the menu is reset, the PCAL password is reset to “9999”.

7.4 Maintaining Calibration Reports... GLP/GMP/ISO Compliant Measurement Management Systems

These settings should be made by the administrator.

7.4.1 Calibration Report Setting

Turns the calibration report function ON/OFF. Use this to generate and output a calibration report as for GLP, GMP or ISO9000. An electronic printer (optional accessory) is required to print the report.

- Turn the printer, EP-100/-110 date printing, ID printing, etc. off for use.

To create calibration report, select menu item **68** [GLP-on]

To turn off calibration report function, select menu item **69** [GLP-off]

7.4.2 Balance ID Setting

Individual balances can be identified by the serial number on the main body of the balance. The user can add a four-digit ID number to the calibration report.

Select menu item **70**. Set a 4-digit number from "0000" to "9999".

8. Environment

8.1 Overview

Settings on the balance can be changed to compensate for the installation environment such as the degree of vibration or air movement or for the purpose of weighing a solid, liquid or powder.

8.2 Stability and Response (Averaging)

These settings select the degree of display stability and response.

The UP Series features outstanding stability and response, however in general, stability and response are contradictory, so if settings are changed to give one or the other priority, it will cause some loss in performance of the other.

In order to maintain compatibility with the UW/UX Series, the stability and response will be the same as the UW/UX Series in any mode other than automatic mode.

Automatic mode can be switched between [UP.AUto] UP Series automatic mode, and [PrE.AUto] UW/UX Series automatic mode.

The current mode is the mode on which the stability symbol is delayed on menus **22** to **26** when the menu is opened.

Auto mode: Select menu item **22** [EA-AUto] (Environment/Averaging-AUTOMATIC)
The balance automatically performs optimum averaging dynamically while observing the load data. This is the recommended setting and should be used unless special circumstances exist.

(To use UW/UX Series automatic mode)

Each time the circle (right side) on the [O/T] key is pressed and held during automatic mode, the balance will switch between UP Series automatic mode and UW/UX Series automatic mode. In addition, when the settings are changed a verification of the new settings will be temporarily displayed in the [].

UP Series automatic mode [UP.AUto] → UW/UX Series automatic mode [PrE.AUto] → UP Series automatic mode [UP.AUto]

During measurement in the UP Series automatic mode the ► symbol will be displayed on the right side of the display.

**Pouring mode:
(Filling, dosing)** Select menu item **23** [EA-PoUr] (Environment/Averaging-POURING)
This mode is particularly suitable for dosing or filling purposes.
Note that this mode is very sensitive to wind and vibration.

(Environmental setting in Pouring mode)

Pouring mode allows further adjustments to the surrounding environmental conditions. Choose the optimal setting for your installation site observing the response and stability.

Every time the circle in the right part of the [O/T] key is pressed during weighing in Pouring mode, the environmental setting will be changed and cycles in the following order. Upon changing the setting, the new setting is briefly displayed as shown in “[]”.

normal environment (“norm E”) → unstable environment, (“UnStb E”) → very stable environment, (“StAbL E”) → normal environment, (“norm E”).

During use, the current environmental setting of Pouring mode can be confirmed by observing the position of the ► symbol in the display.

(Display)	►	When [PrE.AUto]	is selected
	►	When [UnStb E]	is selected
	►	When [norm E]	is selected
	►	When [StAbL E]	is selected



Note

While “Pouring” is selected as the Stability and Response setting, taring the container or zeroing the display cannot be made by pressing the rightmost part of [O/T] key. Press the center or the left part of [O/T] key for taring or zeroing.

However, when using animal weighing mode (11.6), the animal weighing mode operation settings and confirmation display (cond 1 to 3) will take priority.

In addition, this will be used as an indicator to display the status of each mode during animal weighing mode (11.6), solid specific gravity (11.2), and liquid specific gravity (11.3) weighing, so the environmental settings for pouring mode will not be displayed.

Standard mode: Select menu item **24** [EA-Stnd] (Environment/Averaging-StANdard)
This mode is suitable for weighing in a normal environment. Averaging is fixed and does not change dynamically as in the [EA-AUto] mode.

Anti-vibration mode: Select menu item **25** [EA-v ibr] (Environment/Averaging-VIBRation)
Use this mode when the balance is used in a location where there are large vibrations and the display fluctuates in the [EA-AUto] mode. Response is deteriorated at small mass amount changes.

Anti-wind mode: Select menu item **26** [EA-w ind] (Environment/Averaging-WIND)
Use this mode when the balance is used in a location where it is exposed to airflow that causes the display to fluctuate in the [EA-AUto] mode. Response deteriorates further than the [EAi-vibr] mode, but weighing is comparatively stabilized.



Note

If weighing cannot be performed efficiently even with the [EA-wind] mode, change the installation site of the balance or use the optional windbreak (large).

8.3 Stability Detection and Settings

Stability detection is an auxiliary function used for the following purposes.

- (1) **Stability symbol display:** When the weigh is stabilized during measurement, Stability mark is prompted as an auxiliary indication of measurement stability.
- (2) **Stability link function operation:** Operations such as data output and auto zeroing of the below listed functions are triggered by stability detection. Some data output functions operated with communication commands (12.4.3) are also linked to stability detection.

(Functions that employ stability detection)

Auto Print (See 10.3), Auto Zero (See 10.4), Taring/Printing at Stability (See 10.6), Peak Hold (See 11.3), Auto-Memory and Zeroing (See 11.5), Animal Weighing (See 11.6), Formulation Mode (See 11.7).

It is possible to adjust the operation with the following stability detection settings.

It is not usually required to change these settings as they are optimized at default. However, it is allowed to change according to 8.3.1 and 8.3.2 when: wishing to ease the criteria of stability detection under very unstable environmental or sample conditions, or wishing to accelerate automatic data output when using a function that employs stability detection.

- (a) **Stability Detection Band** (8.3.1)
- (b) **Timing of Stability Mark Illumination and Automatic Output** (8.3.2)



Note

Stability mark is an auxiliary device to inform measurement stability. The displayed value may change while the stability symbol remains illuminated if the load is changing slowly, or depending on the stability detection settings.

8.3.1 Stability Detection Band

The default setting is “1 count” and the measurement is regarded to be stable when the display has remained within one display count for a fixed length of time. If stability detection band is set at “2 counts”, it will be regarded to be stable when the display has remained within two display counts.

Selecting a larger stability detection band generally eases the criteria and makes stability mark illuminate more readily. However, it will be more likely for the display to further fluctuate after prompt of stability mark. Try a larger stability detection band when data outputs triggered by stability detection is slow due to very unstable environmental and/or sample conditions.

Stability detection band	1 count (default setting)	2 counts	4 counts	8 counts	16 counts	32 counts	64 counts
Menu item number	27	28	29	30	31*	32*	33*



Note

Only use settings [Eb-16] to [Eb-64] when using auto print, animal weighing mode, and other functions related to output to accelerate stability symbol display under strict floor and sample vibration conditions.

8.3.2 Timing of Stability Mark Illumination and Data Output

The prompt of stability mark and automatic data output of the functions employing stability detection take place at the same timing. The timing after detection of stability is optimized at the default and it is not necessary to change the setting usually. However, adjustment of the timing is allowed to three levels according to specific measurement requirements. When wishing to accelerate automatic data output with functions such as animal weighing, select menu item **21a**. When wishing to delay the prompt of stability mark, select menu item **21c**. Select menu item **21b** to return it to the standard setting.

8.4 Tracking

Tracking is the function that will maintain the current displayed value as long as possible.

To turn ON this function, select menu item **34** [Et-on]

To turn OFF this function, select menu item **35** [Et-off]

Zero Tracking Function

In [Et-on], in order to maintain the zero display for as long as possible when the display is zeroed, a "zero tracking function" will activate which automatically cancels out any minor drift from zero. It is recommended to set [Et-off] to monitor drops of liquid, evaporation processes, or other minute changes in mass.



Note

Using a verified balance as a legal measuring instrument in using region:

Even when Tracking is ON, the range where it works is restricted to the vicinity of the zero, and it is subjected to conditions, according to the regulations.

9. Unit Display Set-up

9.1 Units



Note

Using a verified balance as a legal measuring instrument in using region:

Only g (gramme=gram), ct (carat) weighing units, percentage conversion and piece counting are available for use. Carat is not available for UP822X and UP822Y models.

In the UP Series, using the [UNIT] key to switch modes during mass display allows for displaying of mass in units other than g (refer to 3.2). Configure settings in advance to use only the units you require.

1 Set up the desired units by selecting menu from **54** to **62**.

(Before weighing, set the display units to be used. Gram, %, and PCS (piece counting) are set up before shipment.)

Refer to 10.3, 11.1, and 11.2 respectively for PCS (menu **57**) and specific gravity measurement (menus **60** and **61**).

(Example)



When menu item **58** (carat) has been selected.

2 It is possible to display units other than "g". Press the [UNIT] key in mass display to sequentially change the selected units.



Notes

- The stability symbol will be displayed for the units set as the "Display units to use" on the unit settings menu. →
- Pressing the [O/T] key while the menu for the currently set units (unit for which the stability symbol is displayed) is displayed will cancel the setting. g units cannot be cancelled.
- For user units ([USEr]: display units are ▼) the values (multipliers) to be applied to the g units can be set individually. When registering these values, set a constant other than zero. Setting the values as zero indicates that they are "not used".
- For user units, the results of the measured value multiplied by the measured number of grams is displayed.
- Refer to "A2. Menu map" for units when outputting data.

9. Unit Display Set-up

Display during measurement

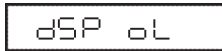
Display	
	Display Overload: This display appears if the mass display exceeds 7 digits due to the choice of unit.

9.2 Percentage (%) Conversion

- 1 Set the % unit with menu item **56** if it is not set up.
(The % unit is set before shipment.)

- 2 Press the [UNIT] key several times in the mass display until the % unit is displayed.



Setting the 100% reference

- 1 Press the [O/T] key to tare the balance.
- 2 Load the reference sample that corresponds to the 100% value. This value must be equivalent to 100 counts or more in the “g” unit.

- 3 When the stability mark prompts, press the [CAL] key.
“SEt” is displayed briefly and the reference sample weight is displayed as 100%.



Note

The numbers of digits displayed in the % unit and rounding off of the minimum digit vary depending on the mass value of the reference sample and the balance model.

It is not possible to obtain resolution greater than that in the “g” unit.

10. Enhancing Productivity

This function is mainly useful for improving productivity at manufacturing sites.

Only one of the functions in the menu group 4 (Refer to 4.3) (41 to 53) can be used at a time. When one of the functions in menu group 4 is to be used with a weighing unit other than gram, select the function from the gram-display first. Then, change to the other unit with the [UNIT] key. To release this function, use the [POWER] key. For returning to the previous function, Last Menu Recall function is convenient. There are some other combinations of functions that can be used together.

10.1 Checkweighing and Target Display

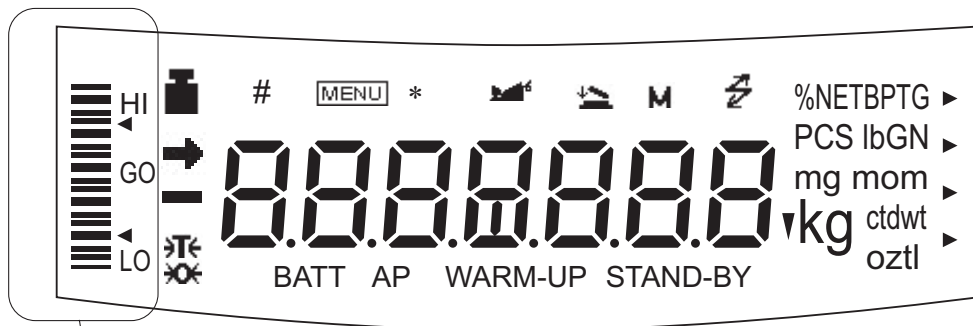

Analog display section

The UP Series balance has an analog bar graph located on the left side of the display.

This graph can be conveniently used for checkweighing or cumulative weighing.

The graphic display functions include the two display modes of checkweighing, the target mode, and full scale mode. Only one of them can be used at a time. Refer to 6.1 for the full scale mode and the no bar graph display.

[SEt] will be displayed after selecting a type in both target display and checkweighing modes. The threshold value for level determination is set as a value for the number of display counts (decimal places are ignored). If the value is not set and left out of the menu settings, only analog display mode types will be selectable. In addition, these values are recorded individually for each analog display mode.

When checkweighing is set, a signal can be extracted that corresponds to the HI, GO, LO of the analog display section from the external key connector on the back of the balance. Refer to A. 4 for optional comparator lamp.

Refer to 4.4 for threshold value and other value settings.

10.1.1 Checkweighing (Comparator) Display Type 1

Checkweighing will be carried out based on the sample load size. Results will be displayed split into groups.

1 Select menu map item **15**

(Displays in use)

2 Set the upper threshold value, which corresponds to the upper triangle mark, with menu item **16** [UPPEr]

3 Set the lower threshold value, which corresponds to the lower triangle mark, with menu item **17** [LowEr]
All are set by the number of display counts for units measured. For example, for types where 200 g is displayed as 200.00 g, the threshold value would be set as 20000.

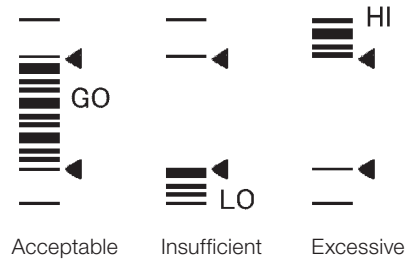

The threshold value to be set and the display count value are compared and then the HI, GO, LO checkweighing results are displayed.

When [UPPEr] < Display count value	HI
When [LowEr] ≤ Display count value ≤ [UPPEr]	GO
When display count value < [LowEr]	LO

10.1.2 Checkweighing (Comparator) Display Type 2

Use this mode for classification based on the sample weight. The display looks like a bar graph, but also includes a checkweighing function.

1 Select menu map item **18**

(Displays in use)

2 Set the upper threshold value, which corresponds to the upper triangle mark, with menu item **19** [UPPEr]

3 Set the lower threshold value, which corresponds to the lower triangle mark, with menu item **20** [LowEr]
All are set by the number of display counts for units measured. For example, for types where 200 g is displayed as 200.00 g, the threshold value would be set as 20000.

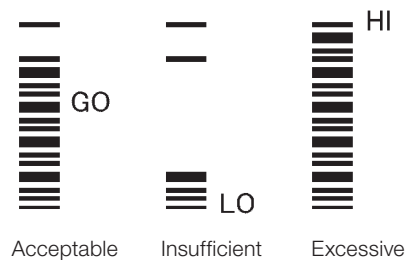

The threshold value to be set and the display count value are compared and then HI, GO, LO are displayed.

When [UPPEr] < Display count value	HI
When [LowEr] ≤ Display count value ≤ [UPPEr]	GO
When display count value < [LowEr]	LO

10.1.3 Target Mode

This mode is useful for constant amount weighing of liquid or judgment of excess and shortage. The target will be indicated as the center line in the analog display. The limits will be indicated as triangle marks. A moving bar represents the current weight on the pan.

- 1** Select the Target mode with menu item **12**
- 2** Set the “target” value, which corresponds to the center line of the graphic display, with menu item **13** [tArGEt]
Refer to 4.4 for numerical value settings.
- 3** Set the “limit” value, which corresponds to the distance between the center line and upper or lower triangle marks, with menu item **14** [L im it]
All are set by the number of display counts for units measured. For types where 200 g is displayed as 200.00 g, the target value would be set as 20000.

(Display examples in use)

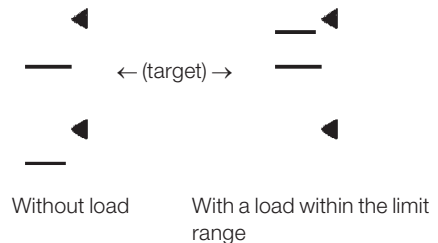

10.2 Piece Counting (PCS)

1 Set up the PCS with menu item **57** if it is not set.
(The PCS unit is set before shipment.)

2 Press the [UNIT] key several times in the mass display until the PCS is displayed.

3 Load the container and press the [O/T] key to tare the balance.

4 Count exactly five pieces (or 10, 20, 50, 100, or 200 pieces) of sample to be measured and load them on the pan.

5 Press the [CAL] key.

6 Every time the [CAL] key is pressed, the display sequentially changes as “Ld 5pcs”“Ld 200pcs”, “Ld 5pcs”...
Press the [O/T] key when the display is equivalent to the number of loaded pieces.



(Example)

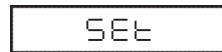

Example: If 50 pieces are loaded, press the [O/T] key when “Ld 50pcs” is displayed.

This determines the unit weight or average weight per piece.

As sample is added or removed, the piece count (number of pieces) is displayed.



Note

When the sample for which piece counting is to be carried out is changed (also when the production lot changes in some cases), it is necessary to reconfigure the unit weight settings (3 to 6 above).

Piece Count Menu Display at Next Setting

In this example, when the [CAL] key is pressed in the next PCS menu, display starts from “Ld 50pcs”.

10.3 Automatic Printing and Output (Auto Print)

Auto Print function allows output of the data automatically without pressing the [PRINT] key for each sample. The [AP] symbol is illuminated when the Auto Print function is activated.

Six types of Auto Print are selectable. The phrase "near zero" in the explanations refers to a positive or negative value within the zero range, for which the absolute value is equal to or greater than 5 times the zero range. Refer to 11.5 for zero range details. Refer to 9.3 for stability detection details.

- Print on loading:** Select menu item **42** [on Ld]
Data will be automatically output one time when a positive value is stably detected after a sample is loaded while a value near zero is displayed. The next data output is not performed unless the display has returned to a value within the Zero Range by unloading the sample or pressing the [O/T] key.
- Print on loading and unloading:** Select menu item **43** [on -Ld]
Data will be automatically output one time when a positive or negative value is stably detected after a sample is loaded or unloaded while an output value near zero is displayed. The next data output is not performed unless the display has returned to a value within the Zero Range by unloading the sample or pressing the [O/T] key.
- Print on loading and on zero:** Select menu item **44** [on 0Ld]
Data will be automatically output one time when a positive value is stably detected after a sample is loaded while an output value near zero is displayed. Unload the sample or press the [O/T] key. When the displayed value is within the Zero Range and stability is detected, data is output again.
- Print on loading, unloading, and on zero:** Select menu item **45** [on -0Ld]
Data will be automatically output one time when a positive or negative value is stably detected after a sample is loaded or unloaded while a value near zero is displayed. Data will be output again when a value near zero is stably detected after a sample is loaded or unloaded again and the [O/T] key is pressed.
- Print continuously:** Select menu item **46** [on Cont]

Not applicable to a verified balance as a legal measuring instrument in using region

By pressing the [PRINT] key while the Auto-Print symbol and Stand-by symbol are lit, the Stand-by symbol goes out, the Communication symbol lights and the displayed data is continuously output.

Continuous output stops temporarily when the [PRINT] key is pressed.



Note

During continuous output, the Communication symbol may appear to remain lit. If the transfer speed of the data output is slow, the display may become unstable. Increase the transfer speed as much as possible and set the handshake off.

Print on “GO” judge of checkweighing:

Select menu item **47** [on Go]

When the checkweighing function is used and stability is detected in the “GO” range, the data is output once. The next data output is executed after the displayed value is within the Zero Range.



Notes

- For automatic outputs at preset intervals, see “11.4”.
- Pretaring Value (10.7) function cannot be used with Auto Print functions.
- Auto Print mode setting can be cleared without menu operation, by pressing the [POWER] key for about three seconds.
- Not more than one of these seven functions can be set at a time. Setting the second one with the menu will automatically clear the previously set function; Auto Print(10.3), Auto Zero(10.4), Peak Hold(11.3), Interval Timer(11.4), Add-on mode(11.5), Animal Weighing mode(11.6), Formulation mode(11.7).
- When minimum display has been switched to 10d (See 6.2), the optimized Zero Range for 1d display may cause failure in the operation (e.g. Data is not automatically output as sample is loaded). Select optimal Zero Range value again when minimum display has been changed (See 10.5 for details).

10.4 Automatic Compensation of Zero Point Drift (Auto Zero)

Not applicable to a verified balance as a legal measuring instrument in using region

When the displayed value is within the Zero Range and stability is detected, zeroing occurs automatically. The Zero symbol appears in the display when the Auto Zero function is active. Other keys function as expected with the Auto Zero function activated. Select menu item **48** to activate it.

Refer to 8.3 for stability detection details.



Notes

- Pretaring Value (10.7) function cannot be used with Auto Zero function.
- Auto Zero setting can be cleared without menu operation, by pressing the [POWER] key for about three seconds.
- Not more than one of these seven functions can be set at a time. Setting the second one with the menu will automatically clear the previously set function; Auto Print(10.3), Auto Zero(10.4), Peak Hold(11.3), Interval Timer(11.4), Add-on mode(11.5), Animal Weighing mode(11.6), Formulation mode(11.7).
- When minimum display has been switched to 10d (See 6.2), the optimized Zero Range for 1d display may cause failure in the operation. Select optimal Zero Range value again when minimum display has been changed (See 10.5 for details).

10.5 Sample Loading and Unloading Determination (Zero Range)

The "Zero Range" value is used in the following functions as a reference for judging whether the sample is loaded: Auto Print (10.3), Auto Zero(10.4), Peak Hold(11.3), Add-on Mode(11.5), Animal Weighing Mode(11.6), and Formulation Mode(11.7). Set the "zero range" to a value suited to your purposes when using these functions.

If the display is within the Zero Range, the balance determines that the balance is not loaded. If the display reaches five times the Zero Range or more, it determines that a sample is loaded. Functions which involves judgment of whether a sample is loaded or not work in accordance with the Zero Range setting.

Example: Samples are weighed one after another with UP2202X (minimum display 0.01g) and each measurement result is automatically output with the Auto Print "on Ld" function (10.3).

Suppose Zero Range is set to 10. As 1 count for UP2202X is 0.01g, Zero Range is 0.10g in this case. When a sample of 0.50g or more is placed, it is judged to be loaded and the data will be output. When this sample is removed and the display returns below 0.10g, it is judged that the balance is unloaded, then it is ready for the next sample. If it does not return below 0.10g, the previous sample is not judged to be unloaded. Therefore, even when the displayed value reaches 0.50g again by next loading, the data will not be automatically output. Select Zero Range value according to the influences of environment (causing difficulty in zero-return), the weight of the samples, etc. so that Auto Print functions properly.

Set the "Zero Range" value with menu item **48**

The setting range is 01 to 99 with 10 being the default value. Even when weighing will be done in another unit, Zero Range setting is made by only gram value. Refer to 4.4 for numerical value settings.



Notes

- Zero Range value is a common setting for all the Zero Range-linked functions.
- The application of Zero Range value is different depending on each function. Refer to the section of each function using Zero Range.
- When a Pretare value is set, the thresholds to determine that there is "no load" becomes " $- \text{Pretare} \pm \text{Zero Range}$ ".
- When the minimum display is switched to 10d (refer to 6.2), the minimum display after the switch will be counted as one count for loading and unloading determination.

As such, for the optimal zero range set before the switch, the value used for loading and unloading determination may be too big, which could result in the function not operating correctly (data not being output even if a sample is loaded, etc.). Reconfigure the zero range settings when switching the minimum display.

10.6 Taring/Printing at Stability

Not applicable to a verified balance as a legal measuring instrument in using region

Determine if the balance should wait for stability before printing when the [PRINT] key is pressed or zeroing when the [O/T] key is pressed. However, if the [PRINT] key is pressed while menu group 4 functions are being used, data will be output without waiting for detection of stability.

Instant operation setting Operates immediately when a key is pressed without waiting for detection of stability.

Select menu item **39**

Stability wait setting Operations after detection of stability. Select menu item **40**



Notes

Operations when waiting for stability (while stability is not detected) are as follows.

- When the [O/T] key has been pressed, “---” is displayed. At this occasion, press the [POWER] key if you desire to disable this function and abort taring.
- When the [POWER] key is pressed
The communication symbol and [STAND-BY] symbol will each be displayed while waiting for detection of stability. Data will be output once stability is detected. Even if the [PRINT] key is used to switch to the standby state while stability is not detected, data will be output when stability is detected for the next measurement.
- See 8.3 for details of stability detection.

10.7 Registering Container Weight (Pretaring Value)

Not applicable to a verified balance as a legal measuring instrument in using region



Notes

- If the weight of the tare (container) varies, accurate measurement with Pretaring Value function cannot be made.
- Pretaring Value function cannot be used with Peak Hold (11.3), Add-on Mode(11.5), Animal Weighing Mode(11.6), Formulation Mode (11.7) or Auto Print function (13.3).

This function is used to weigh the mass of a sample packed in a container such as a bottle or bag without opening the container. Pretare function should be used only if the mass of each container does not vary from sample to sample. Instead of zero, the pretare value is displayed (as a negative value) when the [O/T] key is pressed. The pretare value is then subtracted from the total load on the balance pan to display the weight of the sample.

- 1** Select menu item **36**
- 2** Use the [UNIT] key and [PRINT] key to set the pretaring value, then press the [O/T] key.

Pretare Value

When a Pretare value other than zero has been set, the  symbol illuminates.

- The Pretare value is set using the “g” unit. The maximum value is the weighing capacity of the balance. Refer to 4.4 for numerical value input methods.
- Cancel the pretaring value by setting it to zero.
- Check the Pretare value by pressing and holding the [O/T] key for approximately 3 seconds during weighing.

Use the AKB-301 external keypad if you have to change the Pretare value frequently. To configure settings using the AKB-301, input the pretaring value as numbers, then press the [O/T] key.

11. Application Functions

These are applied measurement functions that can be used with the balance.

Only one of the functions in the menu group 4 (Refer to 4.3) (**41** to **53**) can be used at a time. When one of the functions in menu group 4 is to be used with a weighing unit other than gram, select the function from the gram-display first. Then, change to the other unit with the [UNIT] key. To release this function, use the [POWER] key. For returning to the previous function, Last Menu Recall function is convenient.

There are some other combinations of functions that can be used together. Some functions employ the value set in Zero Range setting (refer to 10.5).

11.1 Solid Specific Gravity Measurement

Solid specific gravity measurement refers to the measurement of the sample (solid) weight in the air and in a liquid of known specific gravity (or density) and the calculation of the sample specific gravity (or density). The ▼d symbol is used to represent the solid specific gravity in this balance. The data output unit is DS.



Note

Use of the optional SMK101A, or SMK-102 Specific Gravity Measurement Kit (refer to A-4.) is recommended for efficient measurements. When using the Gravity Measurement Kit, refer to the instruction manual of the kit. Follow the instruction below when a hanging pan and a tank are prepared by the user.

- 1 Select menu item **60-1**, **60-2** in advance.
60-1: Select either the hold display mode or the continuous display mode for the specific gravity value display. Press the [CAL] key repeatedly until [SG HoLd] appears.
Each time the [O/T] key is pressed the "→"
"symbol on the left side of the display turns on or turns off. The display is configured as shown below according to the on/off state of "→"
"→"on : Hold display mode
"→"off : Continuous display mode (the specific gravity value is updated according to the change of weight in water)
Press the [POWER] key repeatedly to return to the mass display.
Press the [CAL] key to display the medium liquid density setting screen.
60-2 : Enter the value of the medium liquid density (or specific gravity (g/cm³)) (water, alcohol etc.) in which the sample is immersed.
Refer to 4.4 for numerical value input.

11. Application Functions

After entering the value, set using the [O/T] key, then press the [POWER] key two times to return to mass display.

- 2** Remove the below-weigh hook cap from the bottom of the balance to expose the below-weigh hook.
- 3** Hook the hanging pan, and then immerse the hanging pan in the tank filled with the liquid.
- 4** When the [UNIT] key is pressed a number of times from the mass display, [Air▼gd] appears for about two seconds. Afterward, the display switches to the [▼gd▶] display. This is the weight measurement in air mode. During weight measurement in air, "▶" turns on in the upper-right of the display.

- 5** Press the [O/T] key.

- 6** Place the items to be measured on the pan.

(Example)

- 7** When the stability mark appears, press the [CAL] key. This measures the weight of the item being measured in air.

- 8** The display shows [wAtEr▼gd] for about two seconds. Afterward, the display switches to the [▼gd▶] display. This is the weight measurement in water mode. During weight measurement in water, "▶" turns on in the lower-right of the display.

- 9** Place the items to be measured on the immersed hanging pan. The display shows the weight value in water. Press the [CAL] key to show the specific gravity value in the set specific gravity value display mode. Press the [POWER] key to return to **8**. If air bubbles adhered to the item being measured and the result is a specific gravity value that differs from the expected value, you can recalculate the specific gravity value by retrying the weight measurement in water after removing the air bubbles from the item.

(Example)

(Example)

Hold display mode example

- 10** To make the next measurement, unload the pans, press [CAL], and begin again at Step **5**.
When finished measuring specific gravity, press the [UNIT] key.



Notes

- Up to four decimal places are displayed for density or specific gravity. Depending on the measurement conditions, not all digits are stable even the balance is working normally. The [UNIT] key can also be used to change the minimum display.
- **How to change the minimum display in density (specific gravity) display**
When the result is displayed, press and keep holding down the [UNIT] key for about three seconds. This changes the minimum display to 10d (d: original minimum display). Every time the same key operation is made, the minimum display changes and cycles in the order of "1d → 10d → 100d → 1000d → 1d →".
- If liquid specific gravity is input instead of liquid density in Procedure **1 60-2**, the sample specific gravity will be calculated and displayed.
- When placing samples on the immersed hanging pan, make sure the entire sample is submerged in the liquid.
- If using specific gravity measurement kit (special accessory) SMK101A or SMK-102, use according to the kit instruction manual.
- Refer to A8. for below-weigh hook shapes.
- UP Series automatic mode (10.2) cannot be used. Change to UW/UX Series automatic mode.

The "▶" on the top right and bottom right of the display which indicates environmental settings, will not be displayed even when using pouring mode (8.2).

The in air and in water weight measurement display will be given priority.

11.2 Liquid Density Measurement

Liquid density measurement refers to the measurement of the weight of a reference solid of a known volume in air and in the sample liquid. Density of the liquid is calculated from these two values. The display unit for liquid density is “d”. The data output unit is DL.





Note

Use of the optional SMK101A, or SMK-102 Specific Gravity Measurement Kit (refer to A-4.) is recommended for efficient measurements. When using the Gravity Measurement Kit, refer to the instruction manual of the kit. Follow the instruction below when a hanging pan and a tank are prepared by the user.

- Select menu item **61-1**, **61-2** in advance.

61-1: Select either the hold display mode or the continuous display mode for the specific gravity value display. Press the [CAL] key repeatedly until [SG HoLd] appears.

Each time the [O/T] key is pressed the “” symbol on the left side of the display turns on or turns off. The display is configured as shown below according to the on/off state of “”

“”on : Hold display mode

“”off : Continuous display mode (the specific gravity value is updated according to the change of weight in water)

Press the [POWER] key repeatedly to return to the mass display.

Press the [CAL] key to display the sinker volume setting screen.

61-2: Enter the value for the volume (cm³) of the reference weight. Refer to 4.4 for numerical value input.

After entering the value, set using the [O/T] key, then press the [POWER] key two times to return to mass display.
- Remove the below-weigh hook cap from the bottom of the balance to expose the below-weigh hook.
- Hook the hanging pan, and then immerse the hanging pan in a tank containing the sample liquid.

4 When the [UNIT] key is pressed a number of times from the mass display, [Airgd] appears for about two seconds. Afterward, the display switches to the [gd ▶] display. This is the sinker weight measurement in air mode. During weight measurements in air, “▶” turns on in the upper-right of the display.

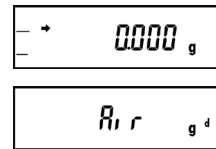

5 Press the [O/T] key.

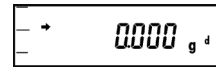

6 Place the sinker on the balance pan.

7 When the stability mark appears, press the [CAL] (Example) key. This measures the weight of the sinker in air.

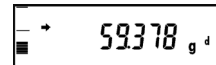

8 [wAtEr gd] appears for about two seconds. Afterward, the display switches to the [gd ▶] display. This is the sinker weight measurements in liquid, “▶” turns on in the lower-right of the display.

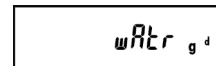

9 Place the sinker in the immersed hanging pan. The display shows the weight value in liquid. Press the [CAL] key to show the liquid density in the set specific gravity value display mode. Press the [POWER] key to return to **8**. If air bubbles adhered to the sinker and the result is a density that differs from the expected value, you can recalculate the density by retrying the weight measurement in liquid.

(Example)

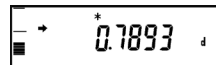

Hold display mode example

10 To make the next measurement, press [CAL], and begin again at Step **5**.



Notes

Up to four decimal places are displayed for density or specific gravity.

Depending on the measurement conditions, not all digits are stable even the balance is working normally. The [UNIT] key can also be used to change the minimum display.

How to change the minimum display in density (specific gravity) display

When the result is displayed, press and keep holding down the [UNIT] key for about three seconds. This changes the minimum display to 10d (d: original minimum display). Every time the same key operation is made, the minimum display changes and cycles in the order of "1d → 10d → 100d → 1000d → 1d →".

- When loading the reference weight on the pan in the liquid, ensure that the entire weight is immersed in the liquid.
- The dimensions of the below-weigh hook are shown in [A-5](#).
- UP Series automatic mode (10.2) cannot be used. Change to UW/UX Series automatic mode.

11.3 Detecting Peak Values (Peak Hold)

Not applicable to a verified balance as a legal measuring instrument in using region

Detects the peak value of a fluctuating weight. "Peak value" is the highest or lowest value displayed in the duration after it has changed beyond five times the Zero Range until the first stability detection after that. The "P" symbol ("P" of Auto-Print symbol) is illuminated when the Peak Hold function is activated. Refer to 8.3 for stability detection details, and 10.5 for zero range details.

Select menu item **49**.

- 1** In the peak detection standby state with the "P" symbol and the Stand-by symbols illuminated, press the [O/T] key to tare the display.
- 2** Press the [PRINT] key. The Stand-by symbol disappears and peak value detection starts.
- 3** Upon stability is detected, the operation of peak value detection is ceased. The detected peak value is displayed with the "P" symbol and Asterisk simultaneously illuminated. The peak value is output to external devices if connected. After this first stability detection, the peak hold function will not operate whether the load on the pan changes or not.
- 4** Press the [POWER] key. The balance returns to the peak detection standby state described in the above step **1**.



Notes

- Press the [POWER] key in the peak detection standby state to initiate the power standby state.
- Press the [POWER] key during detection of the peak to return to the peak detection standby state.
- Peak Hold setting can be cleared without menu operation, by pressing the [POWER] key for about three seconds.
- Polarity of the peak value displayed is “polarity of the displayed value of the first change (by five times or more of Zero Range) from the display within Zero Range.”
- Usually the peak value is easily measured by selecting menu item **23** [EA-PoUr](Pouring mode). Depending on the weighting conditions and the sample type, this setting may not always be suitable.
- Pretaring Value (10.7) function cannot be used with Peak Hold function.
- Refer to 8.3 for stability detection details, and 10.5 for zero range details.
- Not more than one of these seven functions can be set at a time. Setting the second one with the menu will automatically clear the previously set function; Auto Print(10.3), Auto Zero(10.4), Peak Hold(11.3), Interval Timer(11.4), Add-on mode(11.5), Animal Weighing mode(11.6), Formulation mode(11.7). If a function is set via the menu while another function is already set, the original function will be automatically cancelled.
- When minimum display has been switched to 10d (See 6.2), the optimized Zero Range for 1d display may cause failure in the operation. Select optimal Zero Range value again when minimum display has been changed (See 10.5 for details).

11.4 Outputting at Fixed Times (Interval Timer)

Not applicable to a verified balance as a legal measuring instrument in using region

Automatically outputs the displayed value at preset intervals. The “T” symbol (“T” of the Tare symbol) is illuminated when the Interval Timer is activated.

- 1** Select menu item **50** and set the output interval (00:01 = 1 sec to 99:59 = 99 minutes 59 seconds). Refer to 4.4 for numerical value input methods.
- 2** In the interval timer standby state when the “T” and the Stand-by symbols are both illuminated, press the [PRINT] key.
The first data is output. Data will be automatically output at the set time intervals thereafter.
- 3** To stop output, press the [POWER] key.
The balance returns to the interval timer standby state in step **1**).



Notes

- Use the [O/T] key to erase the tare or zero the balance at any time.
- Pressing the [POWER] key in the interval timer standby state brings the power supply standby state.

Interval Timer setting can be cleared without menu operation, by pressing the [POWER] key for about three seconds. This does not clear the set time interval value.

To cancel from the menu, set the interval timer value on menu **50** to zero.

- Using the interval timer function to record data over a long period may cause data error due to balance drift.
- Some instruments receiving the data may not operate normally if the set time interval is short. To correct this, set the time interval to a longer period.
- Not more than one of these seven functions can be set at a time. Setting the second one with the menu will automatically clear the previously set function; Auto Print(10.3), Auto Zero(10.4), Peak Hold(11.3), Interval Timer(11.4), Add-on mode(11.5), Animal Weighing mode(11.6), Formulation mode(11.7). If a function is set via the menu while another function is already set, the original function will be automatically cancelled.

11.5 Measuring a Large Number of Small Samples (Add-on Mode)

This function is convenient for weighing a large number of sample components as they are added on the balance. The **add-on symbol** will be displayed when in this mode.

Select menu item **52**. Used when connected to a printer, etc.

1 Load the weighing vessel and press the [O/T] key in the Add-on standby state (The “Add-on” and the Standby symbols are lit). Zeroing occurs.

2 Press the [PRINT] key. The Stand-by symbol disappears, and Add-on measurement starts.

3 Load the first sample. When stability is detected with a displayed value five times the Zero Range or more, the displayed value is automatically output and zeroing occurs.

Even if the displayed value is less than five times the Zero Range, pressing [PRINT] key at stability causes the same effect.

4 Additional samples can be added and measured without pressing the [O/T] key again.

5 Press the [POWER] key. The total sample mass on the pan is displayed and the balance returns to the Add-on standby state.

Press the [PRINT] key to output the total mass.



Notes

- When stability is detected and the displayed value is within Zero Range, zeroing occurs automatically to maintain the zero display.
- When the [POWER] key is pressed in the Add-on standby state, the power standby state is initiated.
- Add-on Mode setting can be cleared without menu operation, by pressing the [POWER] key for about three seconds.
- Pretaring Value (10.7) function cannot be used with Add-on Mode.
- Refer to 8.3 for stability detection details, and 10.5 for zero range details.
- When add-on mode is on, unit switching and minimum display 1d/10d switching are not allowed.
- When Add-on Mode is ON, fully-automatic span calibration by PSC (7.3.2) or Clock-CAL (7.3.3) is not performed. Weight symbol keeps blinking when span calibration is necessary. Span calibration with the built-in calibration weight or external weights can be performed between sets of measurements (Add-on standby).
- Not more than one of these seven functions can be set at a time. Setting the second one with the menu will automatically clear the previously set function; Auto Print(10.3), Auto Zero(10.4), Peak Hold(11.3), Interval Timer(11.4), Add-on mode(11.5), Animal Weighing mode(11.6), Formulation mode(11.7). If a function is set via the menu while another function is already set, the original function will be automatically cancelled.
- Cannot be used together with the EP-100/-110 printer statistical calculation function.

11.6 Animal Weighing mode

Not applicable to a verified balance as a legal measuring instrument in using region

Designed for weighing live animals. Select menu item **53** to activate Animal Weighing mode. Also, optimize the operational condition (See the following), “Stability Detection Band (8.3.1)” and “Timing of Stability Mark Illumination and Data Output (8.3.2)” depending on the size and movement of the weighed animal. If you weigh rats or mice, refer to the below table showing the typical settings to obtain optimal accuracy and efficiency.

Recommended Settings for Rat and Mouse

Animal	Operational condition (See below)	Stability detection band (See 8.3.1 for details)	Timing of Stability Mark Illumination and Data Output (See 8.3.2 for details)
Rat	Cond3	4 counts (menu item 29)	ES-FAS _t (menu item 21a)
Mouse	Cond1 or 2	1 count (menu item 27 = default setting)	ES-FAS _t (menu item 21a)

Operational condition selection according to the level of animal's movement

Depending on the level of animal's movement, operational condition (response and stability) can be optimized within Animal Weighing mode. At zero display in Animal Weighing mode, operational conditions can be switched using only the [UNIT] key. Select the optimal operational condition by observing the response and stability of measurement.

(3 operation modes)

Operational mode	Level of animal's movement	Remarks
Cond 1	Calm	
Cond 2	Moderate	Not suitable for weighing animal lighter than 50g.
Cond 3	Active	Not suitable for weighing animal lighter than 100g.

Cond 2 and Cond 3 are not suitable for weighing animals lighter than the respectively specified in the above. When lighter animals are weighed with these settings, the zero return after removing the animal may be very slow.

(Switching operational conditions)

Every time the [UNIT] key is pressed at the zero display in Animal Weighing mode, the operational condition will be changed in the following order: The operation mode (Example: [Cond 1]) will be displayed temporarily when switching modes. Thereafter, the confirmation of the operational condition setting can be made observing the position of the **▶** symbol in the right end of the display.

(Operational condition setting check display)

(Display)	▶	When Cond 3 is selected
	▶	When Cond 2 is selected
	▶	When Cond 1 is selected



Notes

- The pouring mode environmental settings will not be displayed even when using pouring mode (8.2).
- The animal weighing mode operation mode setting verification will be given priority.

(Operation)

The Animal symbol  is illuminated when this mode is active. In addition, the ◀ symbol which indicates the operation mode setting (refer to the "Operation mode switching" item) will be displayed on the right of the display.

- 1** Load the weighing vessel and press the [O/T] key to zero the display.
- 2** Load the sample (animal) with a mass more than 50 times the Zero Range.
- 3** When the measurement reaches stability criteria of Animal Weighing, the weighed value is automatically output.
- 4** Unload the animal or press the [O/T] key
- 5** When the mass display becomes less than 10 times the Zero Range and stability is detected, automatic zeroing occurs. The mass of any residue remaining on the balance (excrement or fur) is canceled and returns to zero display.



Notes

- Data may be output when a container is loaded, however this is not an error.
- On the premise of weighing animated objects, the stability detection band is automatically extended in the Animal Weighing mode. Reproducibility of the measurement data is slightly less than with other modes. If a larger stability detection band is selected with the menu (See 8.3.1), stability detection is more readily made and the output of measurement result usually becomes faster. However, the accuracy may become poorer. When changing stability detection band, select according to the specific measurement's requirements on accuracy, observing the reproducibility on the test run.
- See 8.3 for details of stability detection.
- If the balance is slow to automatically return to the zero display, set a larger Zero Range value.
- See 10.5 for details of Zero Range.
- When Menu Lock (4.5.3) is activated, operational condition of Animal Weighing is also locked.
- When Menu reset (4.5.2) is performed, operational condition setting of Animal Weighing is also returned to the default (Cond 1).
- Animal Weighing mode setting can be cleared without menu operation, by pressing the [POWER] key for about three seconds.
- Pretaring Value (10.7) function cannot be used with Animal Weighing mode.
- Small animal bucket set (option, see A-4.) is recommended for weighing small animals such as mice.
- Not more than one of these seven functions can be set at a time. Setting the second one with the menu will automatically clear the previously set function; Auto Print (10.3), Auto Zero (10.4), Peak Hold (11.3), Interval Timer (11.4), Add-on mode (11.5), Animal Weighing mode (11.6), Formulation mode (11.7). If a function is set via the menu while another function is already set, the original function will be automatically cancelled.
- When minimum display has been switched to 10d (See 6.2), the optimized Zero Range for 1d display may cause failure in the operation (e.g. Data is not automatically output as animal is placed). Select optimal Zero Range value again when minimum display has been changed (See 10.5 for details).

The UP Series animal weighing mode (8.2) cannot be used. Change to UW/UX Series automatic mode.

- UP Series automatic mode (10.2) cannot be used. Change to UW/UX Series automatic mode.

11.7 Formulation Mode

This function is convenient for weighing in the components of a formulation. The mass of each component is displayed and stored. Every time a component is added and [PRINT] key is pressed, the mass of that component is output through RS-232C or DATA I/O interface and the display will be automatically zeroed. When all the components have been weighed, the masses are summed up and the total mass is displayed and output by pressing [POWER] key.

Select menu item **51**.

(Operation)

- 1** When Formulation Mode is ON, the display stands at Formulation stand-by status upon entering the mass display. Add-on symbol, Memory symbol and Stand-by symbol are illuminated in the display.
Place a container (if used) and press [O/T] key to tare the display. Note that taring with [O/T] key is not accepted after [PRINT] key is pressed in the following step **2** until [POWER] key is pressed in the step **5**.
- 2** Press [PRINT] key. When external device is connected, “----- FORMULATION MODE -----” will be output.
- 3** Load the first component and press [PRINT] key. Upon stability is detected at a value higher than five times Zero Range, the mass value will be output with a numbering “CMP001 =”. The display will be automatically zeroed after that.
- 4** Repeat step **3** until all the components have been weighed.
- 5** Press [POWER] key.
The total mass will be displayed and output to external devices with a remark “TOTAL =”.
The balance will return to the formulation mode standby state.
- 6** Clear the pan.
Start the next set of measurements from the step **1**.

Output example: 1st component is 0.5361g,
2nd is 0.5422g, 3rd is 0.4488g.

--FORMULATION MODE--	
CMP001 =	0.536g
CMP002 =	0.542g
CMP003 =	0.448g
TOTAL =	1.526g



Notes

- Set the Stability and Response to Pouring mode (menu item **23**), See [18.2](#) if faster response is required.
- Formulation Mode setting can be cleared without menu operation, by pressing the [POWER] key for about three seconds.
- Cannot be used together with Pretaring ([10.7](#)).
- See [8.3](#) for details of stability detection.
- When formulation mode is ON, unit switching and minimum display 1d/10d switching are not allowed.
- When Formulation mode is ON, fully-automatic span calibration by PSC ([7.3.2](#)) or Clock-CAL ([7.3.3](#)) is not performed. Weight symbol keeps blinking when span calibration is necessary. Span calibration with the built-in calibration weight or external weights can be performed between sets of measurements (Formulation stand-by).
- Not more than one of these seven functions can be set at a time. Setting the second one with the menu will automatically clear the previously set function; Auto Print([10.3](#)), Auto Zero([10.4](#)), Peak Hold([11.3](#)), Interval Timer([11.4](#)), Add-on mode([11.5](#)), Animal Weighing mode([11.6](#)), Formulation mode([11.7](#)).
- Cannot be used together with the EP-100/-110 printer statistical calculation function.

Connecting External Equipment

It is possible to output weight values, setting details and other data from printers, PLCs and other serial communication equipment, and to personal computers. This section explains useful functions for connecting and outputting data to these types of external equipment. The rear of the balance is equipped with various types of connectors that are compatible with the external equipment that is to be connected.

12.1 Connecting Printers

It is possible to connect the special EP-100/EP-110 printers for printing weight values, setting statuses and other data. Connect the printer to the balance in accordance with the following procedures.

- 1** Switch off the power to the balance and the printer
- 2** Firmly connect the cable (supplied with the printer) from the RS232C serial connector on the balance to the connector on the printer
- 3** Switch on the power to the balance
- 4** Switch on the power to the printer
- 5** Press [PRINT] on the balance, and then check operations to make sure the measurement values are printed normally.

EP-100/EP-110 Printer

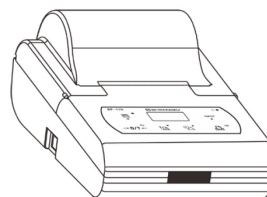

Special cable is provided

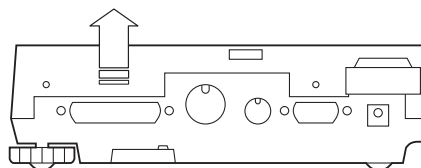

Rear of the balance



Note

Points to Note

Switch off the power to the printer before switching off the balance.
Refer to the printer's instruction manual for details on the printer.

GLP output Function and the Printer's Statistical calculation Function

The printer's Statistical calculation function cannot be used when the GLP output function has been set at ON.

12.2 Connecting Personal Computers

It is possible to output the weight values as well as the printer, using the (P/N:S321-62520-01 USB-Serial replacement kit) of optional. Connect personal computers to the balance in accordance with the following procedures.

- 1 Switch off the power to the balance.
- 2 Connect the USB-Serial replacement cable between the USB connector on the PC.
- 3 The USB driver will be automatically installed on the PC.
- 4 Connect the USB-Serial replacement cable to the [RS 232C connector] on the rear of the balance using RS232C cable(25P-9P).
- 5 Switch on the power to balance.

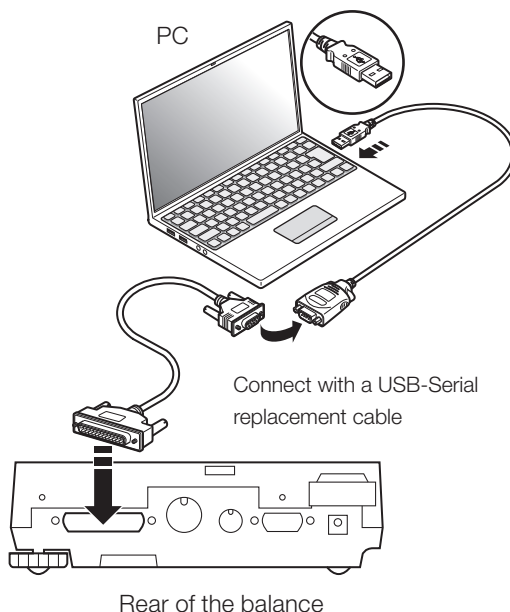

Notes

If the USB driver does not install correctly

There are cases in which the USB driver will not be installed correctly if the personal computer concerned is not connected to the Internet (not connected to a LAN).

In this event, download the following instruction manual and USB driver from the Internet, and perform the installation procedure once again.

USB Interface Driver and Installation Manual Download Page

<https://www.shimadzu.com/an/balance/moisture/moc63u3.html>

- 6 Download the [Balance Keys] software for collecting data
 - (1) Log into a personal computer equipped with Internet access with administrator authority.
 - (2) Start up the browser, and access the following site.
<https://www.shimadzu.com/an/balance/index.html>
 - (3) Click on [Download] on the [Balance Keys Data Collection Software] page, and then download the file in accordance with the on-screen instructions.



Notes

[Balance Keys] data collection software

It is the [Balance Keys] software that enables numerals entered from keyboards with the use of the balance's serial communication function to be easily transferred to the position where the PC cursor lies. Data can be directly loaded as long as key input is possible, regardless of the application.

Points to Note

- If communications are to be performed with communication software installed onto the personal computer, make sure the settings are made in accordance with the instructions for that software.
- Programming that uses command codes is necessary to control the balance from a personal computer.

7 Decompress the downloaded [Balance Keys] file
Right-click on the file downloaded in Step **5**, and then click on [Open All] or [Decompress].

8 Set up [Balance Keys]
See the instruction manual for the [Balance Keys Data Collection Software] decompressed in Step **6** for details on set-up, start up the setup file (Setup.exe), follow the instructions displayed to set it up, and then set the [Balance Keys] parameters.

9 Confirming operations
Run an operation test while setting the parameters by pressing [PRINT] on the balance and checking that the measurement values displayed are correct. If everything is normal, press the [TEST OK] button. Next, start up [Excel] (or [Notepad] or a similar application) on the personal computer. Key input will be enabled, and the cursor will be displayed at a location where input is possible. Press [PRINT] on Balance, The values displayed on the balance will be transferred to the cursor position.

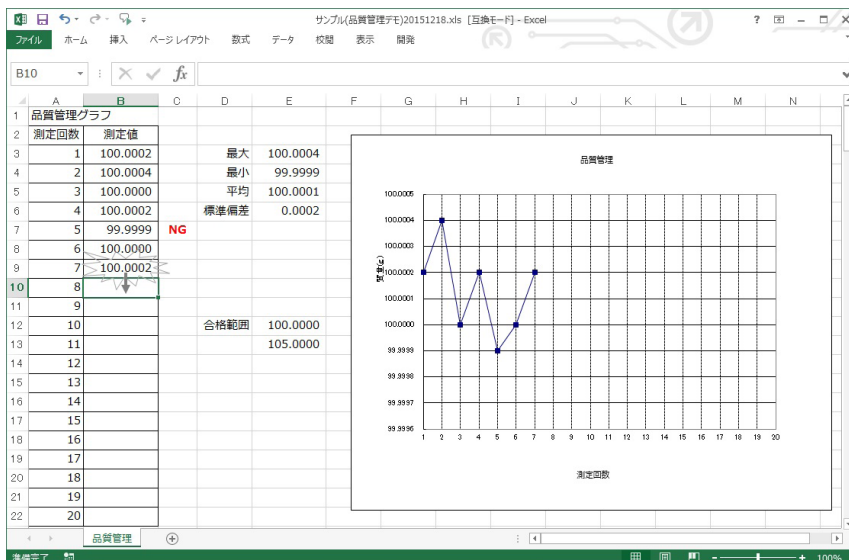

Example of balance data loaded onto an Excel worksheet

12.3 Connecting PLCs and Other Serial Communications Equipment

It is possible to connect PLCs and other serial communication equipment to output weight values, perform taring and calibration with special commands, and read and write setting values. Connect the equipment to the balance in accordance with the following procedures in this event.

- 1** Switch off the power to the balance and other equipment.
- 2** Firmly connect the [RS232C] connector on the rear of the balance to the communication connector on the equipment with the use of a special cable prepared by the user.
* See [Cable Connections (RS232C)] (P.79).
- 3** Switch on the power to the balance.
- 4** Switch on the power to the equipment.
- 5** Align the Communication settings on the balance to the settings on the equipment.

PLCs and other serial communication equipment



Cables to be prepared by the user

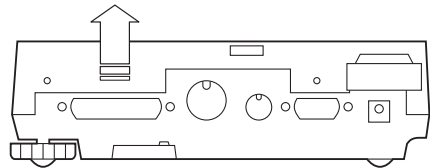

Rear of the balance



Notes

Procedures for confirming operations for the serial communications equipment connected

There are many different types of communications specifications for serial communications equipment depending on the manufacturer and the equipment concerned. Read the instruction manual for the relevant equipment first of all, and then check operations in accordance with the following procedures.

(1) Check the cable connection, (2) Check that the communication conditions are in alignment, (3) Establish communications procedures, (4) Check operations.

- 6** Either press [PRINT] on the balance or send and receive a command from the equipment to check whether the weight value has been correctly input and output.

12.4 Cable Connections (RS232C)

12.4.1 Connecting the Cable

⚠ Caution

- The cable must have the correct connections as shown in the diagram below.
- Cables with the connections shown below and the special accessory RS-232 cable are not guaranteed to operate properly for all types of computers and devices.

(1) D-sub9 pin (Cross connection = Reverse connection)

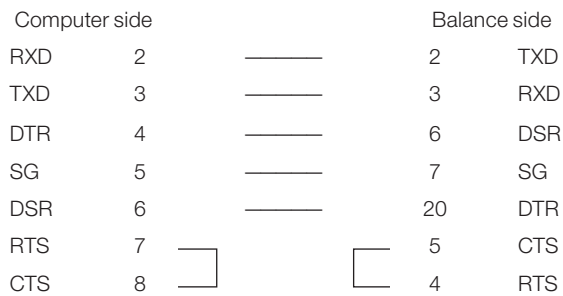

12.4.2 Data Format

The detailed information on the standard format for Shimadzu electronic balances (Menu item **77**, "EB type". Refer to 12.3.3) is given here.

(1) Basic format

An example of data format of a negative value (-186.65g) with delimiter of C/R is shown.

The data length varies depending on attached information, unit expression and delimiter as explained in (2).

Data length of this example: 12 bytes												
Position	1	2	3	4	5	6	7	8	9	10	11	12
ASCII code	2DH	20H	20H	31H	38H	36H	2EH	36H	35H	67H	20H	0DH
data	-			1	8	6	.	6	5	g		C/R

Remarks

- Position1: For a positive value, " " (space), and for a negative value, "-" is in this position.
- Position 2 ~ 9: The absolute value. When the numerical value does not use all the 8 positions, the code for space is entered to each excessive position as shown in this example.
- Position 10,11: One or two letters indicating the weighing unit. As shown in this example, the code for space is entered at position No.11 if only one letter is used for the unit.
- Position 12: Code for delimiter.

(2) If data length is longer than standard

(i) **Output with stability information**

When outputting data with stability information (Refer to 12.2.3 (4)-(i)), either of the following characters is added in front of Character No.1 in the example. Consequently, the data becomes 1 byte longer.

When stable: S

When unstable: U

(ii) **When the delimiter "C/R+L/F" is selected (Menu item No. **96**). Refer to 12.3.7)**

The delimiter information requires one more character. Therefore one more byte is added after Position No.12 in the above example. Consequently, the data becomes 1 byte longer.

(3) Data format in case of “oL” or “-oL” (Overload)

The below is the data format for “oL”.

Data length of this example: 12 bytes												
Position	1	2	3	4	5	6	7	8	9	10	11	12
ASCII code	20H	20H	20H	20H	20H	4FH	4CH	20H	20H	20H	20H	0DH
Data						O	L					C/R

For “-oL” (negative overload), Position 1 is replaced with “-” (minus, ASCII code: 2DH).

The following parts appearing in “(2) Information of additional bytes” also apply to (3).

(i) Output with stability information

(ii) When the delimiter “C/R+L/F” is selected, (Menu item No **96 , Refer to 12.3.7.)**

12.4.3 Using Command Codes



Note

If communication conditions are incorrectly set, a communication error message [ComErr] is displayed.

- (1) Commands that end with a number, character, or symbol other than [=]: Transmit to the balance with a delimiter for each command code.

Example 1: PRINT<CR>...The same operation as pressing the [PRINT] key

- (2) Commands from (4) below which end in "="
Transmit to the balance with a delimiter added to the end after transmitting a number (including decimal places in some cases) following one command code.

Example 2: TIME=1234<CR>
...12:34 is set as the current time.

Example 3: P.TARE=1.23<CR> (example of type of the second decimal place)
...1.23g is set as a Pretare value.

Example 4:) P.TARE=0.00<CR> (example of the second decimal place)
...Clears (cancels) the Pretare value.



Note

Number of digits, decimal point, position of decimal point of the numeral transmitted succeeding to '=' are the same as the case of setting the numeric value using the AKB-301 Application Keyboard.

Use the same number of decimal places as in the gram-display. This restriction does not apply to USER=, SOLID=, and LIQUID=.

Weighing capacity work instructions and display of arbitrary numbers on the balance can be performed from a PC connected to the balance.

These commands will each display as "# = 2.56" and "# = 12.345.67" on the balance display. If the balance operator presses the [PRINT] key after seeing these messages, the text strings '2-56<CR>' and '12-345-67<CR>' will be output from the balance.

(3) Echo back command

The balance again transmits the character strings of N pieces included between an echo back command '{' or '}' and the delimiter. An unprocessed echo back command is not left in the receiving buffer of the balance, $N \leq 30$.

Example 5: {ABCDEFGH12345<CR>

...After receiving this command, the balance outputs ABCDEFGH12345<CR>.

When using the balance together with a printer, these text strings can be printed to the printer.

(Printing of arbitrary text strings)



Note

Only capital alphabets and a part of symbols (decimal point, symbol etc.) can be used when printing with an electronic printer. A maximum of 15 characters per line.

(4) Command codes for Format EB type (menu item **77**) [F-PrEEb]) and Format Old EB type (menu item **78**)

(i) Commands related to output

D01	Continuous output*	} (The balance continuously outputs every about 80ms**)
D03	Continuous output with stability information*	
D05	Single output	
D06	Auto Print setting (type of Auto Print is set separately)	
D07	Single output with stability information***	
D09	Release of continuous output and Auto Print	

(ii) Commands related to operation keys

POWER	Equivalent to the [POWER] key.
Q	Equivalent to the [POWER] key.
MENU	Equivalent to the [CAL] key.
TARE	Equivalent to the [O/T] key.
T	Equivalent to the [O/T] key.
UNIT	Equivalent to the [UNIT] key.
PRINT	Equivalent to the [PRINT] key.
POWER+	Equivalent to holding the [POWER] key
MENU+	Equivalent to holding the [MENU] key
UNIT+	Equivalent to holding the [UNIT] key
PRINT+	Equivalent to holding the [PRINT] key
RECALC	Equivalent to the [RECALC] key of the AKB-301 Application Keyboard.
C	Equivalent to the [C] key of the AKB-301 Application Keyboard.

***Not applicable to a verified balance as a legal measuring instrument in using region**

****Handshake is "OFF" or "Hardware"**

*****Using a verified balance as a legal measuring instrument: Only output at stable.**

(iii) Commands related to application measurement

PEAK	Sets the Peak Hold mode.*
AZERO	Sets the Auto Zero mode ON.*
INTERVAL	Sets the Interval Timer mode.*
MEMORY	Sets the Formulation mode.
M	Immediately operates after setting the Formulation mode.
ADDON	Sets the Add-on mode.
+	Immediately operates after setting the Add-on mode.
A	Sets the Animal Weighing mode.*
ANIMAL	Sets the Animal Weighing mode.*
R	Releases the Application weighing mode.

(iv) Commands related to unit conversion

g	Switches to "g" unit.
kg	Registration of "kg" unit and switching
mg	Registration of "mg" unit and switching.*
PERCENT	Registration of "%" unit and switching.
%	Sets 100% when display is in "%" unit.
G	g ← → % switching.
PCS	Registration of "PCS" unit and switching.
CT	Registration of "carat" unit and switching.
MOM	Registration of "momme" unit and switching.*
SD	Registration of "solid density" unit and switching.
LD	Registration of "liquid density" unit and switching.
CU	Switches to "user" unit (Set the conversion coefficient beforehand.).
RSTUNIT	Returns the default units.

(v) Readout commands of set value

TARGET	Readout of target set value.
LIMIT	Readout of limit set value.
G.LO	Readout of lower limit set value in Checkweighing Display 1.
G.UP	Readout of upper limit set value in Checkweighing Display 1.
L.LO	Readout of lower limit set value in Checkweighing Display 2.
L.UP	Readout of upper limit set value in Checkweighing Display 2.
UW	Readout of unit weight set value.
G/PCS	Equivalent to g/PCS key.
CALWT	Readout of external weights set value for span calibration.*
ACALT1	Readout of Clock-CAL time 1.
ACALT2	Readout of Clock-CAL time 2.
ACALT3	Readout of Clock-CAL time 3.
P.TARE	Readout of Pretare set value.*
ZRNG	Readout of Zero Range set value.
USER	Readout of user unit conversion coefficient.*
VOL	Readout of reference weight set value.
DENSE	Readout of surrounding liquid density set value.
I.TIME	Readout of Interval Timer set value.*

*Not applicable to a verified balance as a legal measuring instrument in using region

(vi) Commands for numeric value setting

CALWT=	Sets external weights value for span calibration.*
ACALT1=	Sets Clock-CAL time 1.
ACALT2=	Sets Clock-CAL time 2.
ACALT3=	Sets Clock-CAL time 3.
P.TARE=	Sets Pretare value.*
ZRNG=	Sets Zero Range value.
UW=	Sets unit weight.
USER=	Sets user unit conversion coefficient.*
VOL=	Sets volume of reference weight.
DENSE=	Sets surrounding liquid density.
I.TIME=	Sets interval timer value.*
DATE=	Sets the date.
TIME=	Sets the time.
TARGET=	Sets the target value.
LIMIT=	Sets the limit value.
L.LO=	Sets the lower limit value of Checkweighing Display 1.
L.UP=	Sets the upper limit value of Checkweighing Display 1.
G.LO=	Sets the lower limit value of Checkweighing Display 2.
G.UP=	Sets the upper limit value of Checkweighing Display 2.
PCS=	Sets the arbitrary loading piece.
#=	Corresponds to numeral keys of AKB-301 Application Keyboard.
ID=	Sets ID.
PASSSET=	Sets PCAL password.*
PASS=	Inputs PCAL password.*

(vii) Commands of special functions

CAL	Enters Span Calibration mode.
C18	Enters Span Calibration mode.
LOCK	Sets menu lock.
RELEASE	Releases menu lock.
TIME	Readout of date and time.
RSTMN	Menu reset.
{	Echo back.
}	Echo back.

*Not applicable to a verified balance as a legal measuring instrument in using region

12. Connections and Communications with External Equipment

(5) Compatible commands with Mettler Toledo® PR and SR Series Electronic Balances

S	One time output at a stable state
SI	Immediate one time output*
SIR	Continuous output*
SR	Continuous output at a stable state
T	Taring after stabilized
TI	Immediate taring*
Z	Zero setting (same as immediate taring)*

(6) Compatible commands with Sartorius® IPS Series Electronic Balances

<ESC> P	One time output
<ESC> T	Taring



Note

<ESC> indicates escape code (1BH).

***Not applicable to a verified balance as a legal measuring instrument in using region**

12.5 Communication Setting

12.5.1 Overview

This menu is used to set the specifications for communication between the balance and a personal computer or electronic printer.

This menu affects both the RS-232C and DATA I/O at the same time. For the instrument to be connected to the DATA I/O connector such as an electronic printer, select the communication setting of the balance to the default settings, which are menu items [H-tm] **76**, [F-Eb] **77**, [b-1200] **83**, [P-no] **89**, [S-1] **92**, [d-Cr] **94**.

12.5.2 Handshaking

Determine the specifications for handshaking.

To have software handshaking not performed, select menu item **73** [H-oFF]

To have software handshaking performed as the following,
select menu item **74** [H-SoFt]

After the balance receives X-OFF (13H), the balance output is retained.

After the balance receives X-ON (11H), the balance output is initiated.

To have hardware handshaking performed as the following,
select menu item **75** [H-HARd]

When DTR is OFF, the output from the balance is retained.

When DTR is ON, the output from the balance is initiated.

To have timed hardware handshaking performed,
select menu item **76** [H-tm]



Notes

- Handshaking determines whether the peripheral equipment can receive communication data from the balance. This function does not relay the status of the balance to the peripheral equipment.
- The balance is able to receive as long as there is space in the receiving buffer of the balance. This function operates once “oFF” is displayed, operation in other states is not guaranteed.
- When the balance output is retained by handshaking, the display of the balance is locked. Determine the specifications for handshaking.

12.5.3 Format

Set the balance output data format.

The standard format for the Shimadzu electronic balance:

Select menu item **77** [F-Fmt 1]

The old output format for the Shimadzu electronic balance:

Select menu item **78** [F-PrEEb]

The old output format is employed in the following models.

EB-500, 5000, 280, 2800, AEL-160, EB-50K (except -15)



Note

In this format, the number of the lowest place of menu item [70] [SC- id] is assigned to identify the balance.

Compatible format for the PR and SR Series of Mettler-Toledo electronic balances:

Select menu item **79** [F-Fmt 3]

Available commands, functions and responses are limited

Compatible format for the IS Series of Sartorius electronic balances:

Select menu item **80** [F-Fms 4]

Available commands, functions and responses are limited

12.5.4 Communication Speed

Select the communication speed (300, 600, 1200, 2400, 4800, 9600, 19200, 38400BPS)

Number of "b-xxx" shows bps (bits/second). Baud rate and bps are the same value.

Select one of the menu items **81** ~ **88**

12.5.5 Parity / Bit Length

Select the parity and bit length.

No parity, 8-bit length: Select menu item **89** [P-no]

Odd number parity, 7-bit length: Select menu item **90** [P-odd]

Even number parity, 7-bit length: Select menu item **91** [P-EvEn]

12.5.6 Stop Bit

Select the number of stop bits.

Stop bit 1:	Select menu item 92	[S-1]
Stop bit 2:	Select menu item 93	[S-2]

12.5.7 Delimiter

The “delimiter” is used to separate individual pieces of data or commands.

Set to CR(0DH):	Select menu item 94	[d-Cr]
Set to LF(0AH):	Select menu item 95	[d-LF]
Set to CR+LF(0D0AH):	Select menu item 96	[d-CrLF]
Set to Windows Direct setting of UW/UX series (down):	Select menu item 97	[d-win]
Set to Windows Direct setting of UW/UX series (right):	Select menu item 98	[d-win -]

12.6 Decimal Point Symbol in Output Data

The decimal point symbols in the outputted data to external devices can be selected from “.” (period) or “,” (comma) depending on your preference. Note that the decimal point expression on the balance display is always with “.” (period).

To select “.” as outputted decimal point,

select menu item number **72a** [dECP-Pr]

To select “,” as outputted decimal point,

select menu item number **72b** [dECP-Cn]



Note

The setting made here in “Decimal Point Symbol in Output Data” will not be cleared with Menu reset (See 4.5.2).

13. Maintenance and Transportation

13.1 Maintenance

If dirty

Use a soft damp cloth containing a neutral detergent to clean the balance.

The pan can be removed and washed with water. Verify that the pan is completely dry before replacing it on the balance.

Avoid using organic solvents, chemicals, or dusting sprays as they may damage the coatings of the balance or the display panel.

Attach the protective in-use cover (standard accessory) when the balance is used in an environment where it is susceptible to being soiled.

13.2 Moving the Balance

To carry the balance ... hold the balance firmly with both hands.

To transport the balance ... use the shipping carton used to deliver the balance.

For the UPX Series, after disconnecting all accessories from the balance main body, rotate the transportation screws on the bottom of the balance clockwise until they stop before placing the balance in the packaging box.

The UPY Series is not equipped with transportation screws. Place the UPY Series balance in the packaging box as-is to move.

Caution

When tightening the UPX Series transportation screws, turn the balance main body over as described in steps **1** and **2** of "2.3 Installation". Make absolutely sure to remove the pan supporter caps first.



Note

Using a verified balance as a legal measuring instrument in using region:

Span calibration must be newly performed with the built-in calibration weight after the balance has been moved and re-installed.

14. Troubleshooting

14.1 General Display

Display	Description of message
---	Wait for next display
- 10d -	Minimum display resolution is decreased by one decimal place.*
- 1d -	Minimum display digit is returned to original state.*
-t ime-	Date and time are being output.
Abort	Operation was aborted.
APL End	Application Measurement was released.
d ouEr	Calibration check detects too large error.
d UndEr	Calibration check detects too large error.
LoCKEd	Menu lock is applied. "Attempted to open menu while menu was locked"
rELeASE	Menu lock is released.
rESEt	Menu was reset.
SEt	Contents of new setting and coefficient were stored.
oFF	Reset by power failure.
wA it	Built-in weight is moving. Wait.
All numerals blinking	Place the displayed calibration weight.

*Not applicable to a verified balance as a legal measuring instrument in using region

14.2 Error Display

Error display	Description	Countermeasure
CAL E0	Trouble in weight loading mechanism	Check transportation screws.(Refer to 2.3)
CAL E1	The load on the pan is unstable at calibration	Avoid wind and vibration.
CAL E2	The drift of zero point is large at calibration.	Install the pan properly. Unload the pan.
CAL E3	The drift is large at the time of PCAL	Use correct weight.
CAL E4	The drift is large at span calibration	Use correct weight.
CAL E5	Calibration weight is wrong	Use correct weight.
CHE x	Failure in the balance (Stops when this is displayed)	Contact the service company
ComErr	Received command code is not correct	Check delimiter etc.(Refer to 12.3)
dSP oL	Integer of the displayed unit exceeded 7 digits	Decrease the load.
Err 0x	Failure in the balance.	Contact the service company
Err 10	PCAL password error	Check the password.(Refer to 7.3.5)
Err 20	Attempted to set improper numeric value.	Review the numeric value and decimal places.
LoCKEd	Menu item selection was attempted when menu is locked.	Release menu lock. (Refer to 4.5.3)
Err 24	Supply voltage is abnormal.	Check the supply voltage.

14.3 Troubleshooting

Symptom	Probable cause(s)	Countermeasure
Nothing is displayed.	<ul style="list-style-type: none"> The AC adapter is disconnected. The breaker of the room is off. The voltage is wrong. 	Check the power and connect AC adapter correctly.
"OL" or "-OL" is displayed.	Transportation screws haven't been loosened.(UPX only)	Turn them anti-clockwise until they stop.
	The pan is displaced.	Place the pan properly.
	Pan supporter caps are not installed.	Install pan supporter caps.
	The load on the pan is too large.	Use balance within its capacity.
Display does not change when pan is loaded.	Pan is displaced.	Place the pan properly.
The display fluctuates and it is difficult to get the stability symbol to display.	Affected by vibration or air flow.	Install the balance at a proper site. Try changing environment settings.
	Protective in-use cover touches the pan.	Adhere the cover firm to the balance body.
The weighed result is not accurate.	Span calibration has not been done.	Calibrate it properly.
	Balance was not zeroed before measurement.	Press the [O/T] key to zero the mass display before measuring.
Does not display the unit desired to use.	The unit has not been set up	Set it up in advance.
Menu item selection is rejected.	Menu Lock is ON.	Release Menu Lock. (See 4.5.3)
An error code is shown.		→ See "Error Display" (14.2)

14.4 LCD (Liquid Crystal Display) Check

The display can be configured to standby in the whole lighting display mode when pressing the [POWER] key in the power supply standby state to switch to mass display mode. If set to [E8-StoP], numbers will be displayed like an electronic scoreboard when powering on for easier verification.

Mode for temporarily stopping in whole lighting display mode for standby

select the menu item **37** [E8-StoP]

When the display holds, press the [O/T] key to proceed to the mass display.

Mode for automatically switching to mass display after approximately 0.5 seconds of whole lighting display

select the menu item **38** [E8-Cont]

If all items are not displayed in the whole lighting state as shown in the figure in 1.3, contact the service company, etc.

- Refer to Chapter 4 for menu setting details.

Appendices

A-1. Specifications

UPX Series Model	UP223X	UP423X	UP623X	UP823X	UP1023X	UP2202X	UP4202X	UP6202X	UP422X	UP822X	UP4201X	UP8201X
Capacity	220g	420g	620g	820g	1020g	2200g	4200g	6200g	420g	820g	4200g	8200g
Minimum display	0.001g	0.001g	0.001g	0.001g	0.001g	0.01g	0.01g	0.01g	0.01g	0.01g	0.1g	0.1g
Calibration range with external weights	100 - 220g	100 - 420g	100 - 620g	400 - 820g	500 - 1020g	1000 - 2200g	1000 - 4200g	1000 - 6200g	100 - 420g	100 - 820g	1000 - 4200g	1000 - 8200g
Repeatability (σ) [count]	≤1								≤0.8			
Linearity [count]	±2			±3		±2			±1			
Ambient temperature and humidity	5 - 40°C 30 - 85% (No condensation)											
Temperature coefficient of sensitivity [ppm/°C](10~30[°C])	±3								±5			
Pan size (mm) approx.	108 X 105					170 X 180			108 X 105		170 X 180	
Main body dimensions (mm) approx.	190W X 317D X 79H					190W X 317D X 81H			190W X 317D X 79H		190W X 317D X 78H	
Weight (kg) approx.	3.4					4.6			3.4		4.6	
Display	LCD with backlight											
Rated electric power supply	DC 12V, 1A											
Data I/O	RS-232C, PATA I/O, AUX, KEY Connector											
Pollution Degree*	2											
Overvoltage Category*	II											
Altitude	Up to 2000 m											
Installation Site	device may only used indoors											
AC adapter (primary)	AC100V, 0.3A 50/60Hz											
Major functions and features	Fully-automatic span calibration (PSC)											
	Clock-CAL											
	ISO/GLP/GMP conformance											
Other functions	Analog display, % display, PCS, User unit, Animal weighing, Specific gravity measurement S/W, Checkweighing											

UPY Series Model	UP223Y	UP423Y	UP623Y	UP823Y	UP1023Y	UP2202Y	UP4202Y	UP6202Y	UP422Y	UP822Y	UP4201Y	UP8201Y
Capacity	220g	420g	620g	820g	1020g	2200g	4200g	6200g	420g	820g	4200g	8200g
Minimum display	0.001g	0.001g	0.001g	0.001g	0.001g	0.01g	0.01g	0.01g	0.01g	0.01g	0.1g	0.1g
Calibration range with external weights	100 - 220g	100 - 420g	100 - 620g	400 - 820g	500 - 1020g	1000 - 2200g	1000 - 4200g	1000 - 6200g	100 - 420g	100 - 820g	1000 - 4200g	1000 - 8200g
Repeatability (σ) [count]	≤1						≤0.8					
Linearity [count]	±2			±3		±2			±1			
Ambient temperature and humidity	5 - 40°C 30 - 85%(No condensation)											
Temperature coefficient of sensitivity [ppm/°C] (10-30[°C])	±3						±5					
Pan size (mm) approx.	108 X 105					170 X 180			108 X 105		170 X 180	
Main body dimensions (mm) approx.	190W X 317D X 79H					190W X 317D X 81H			190W X 317D X 79H		190W X 317D X 78H	
Weight (kg) approx.	2.7					2.9			2.7		2.9	
Display	LCD with backlight											
Rated electric power supply	DC 12V, 1A											
Data I/O	RS-232C, DATA I/O, AUX, KEY Connector											
Pollution Degree*	2											
Overvoltage Category*	II											
Altitude	Up to 2000 m											
Installation Site	device may only used indoors											
AC adapter (primary)	AC100V, 0.3A 50/60Hz											
Major functions and features	ISO/GLP/GMP conformance											
Other functions	Analog display, % display, PCS, User unit, Animal weighing, Specific gravity measurement S/W, Checkweighing											

*Refer to our company website (<https://www.an.shimadzu.co.jp/balance/index.htm>) for details.

A-2. Menu Map

- [CAL] key : moves to the next menu in the same hierarchy. (↓ in menu map)
- [O/T] key : moves to the menu of one hierarchy down. (→ in menu map)
When no menu exists in the menu of one hierarchy down, it is fixed.
- [POWER] key : Switch to 1 step higher menu level. (← in below figure)
(Pressing and holding the [POWER] key will return to mass display)

Refer to 4.3 for menu item selection.

Important Note on Menu Item Selection

Even the desired menu item is reached and displayed, it is not yet set unless Stability mark (➡) is illuminated with it. Do not fail to press [O/T] key to put Stability mark before returning to the mass display.

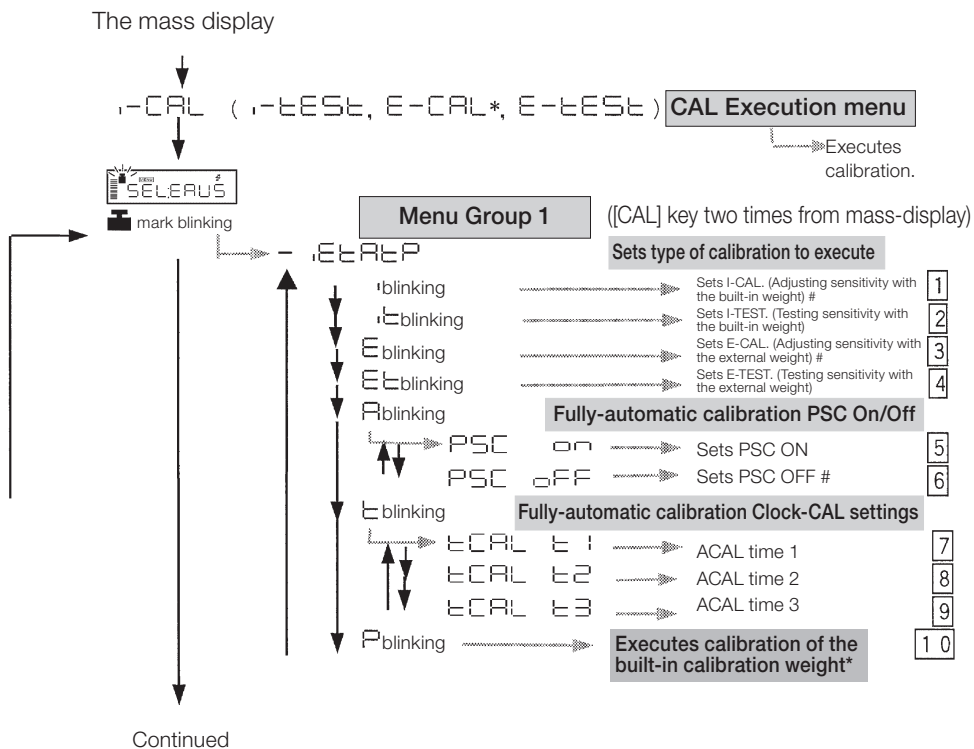

- [No.] : Menu item number
- #: Default settings

*Not applicable to a verified balance as a legal measuring instrument in using region

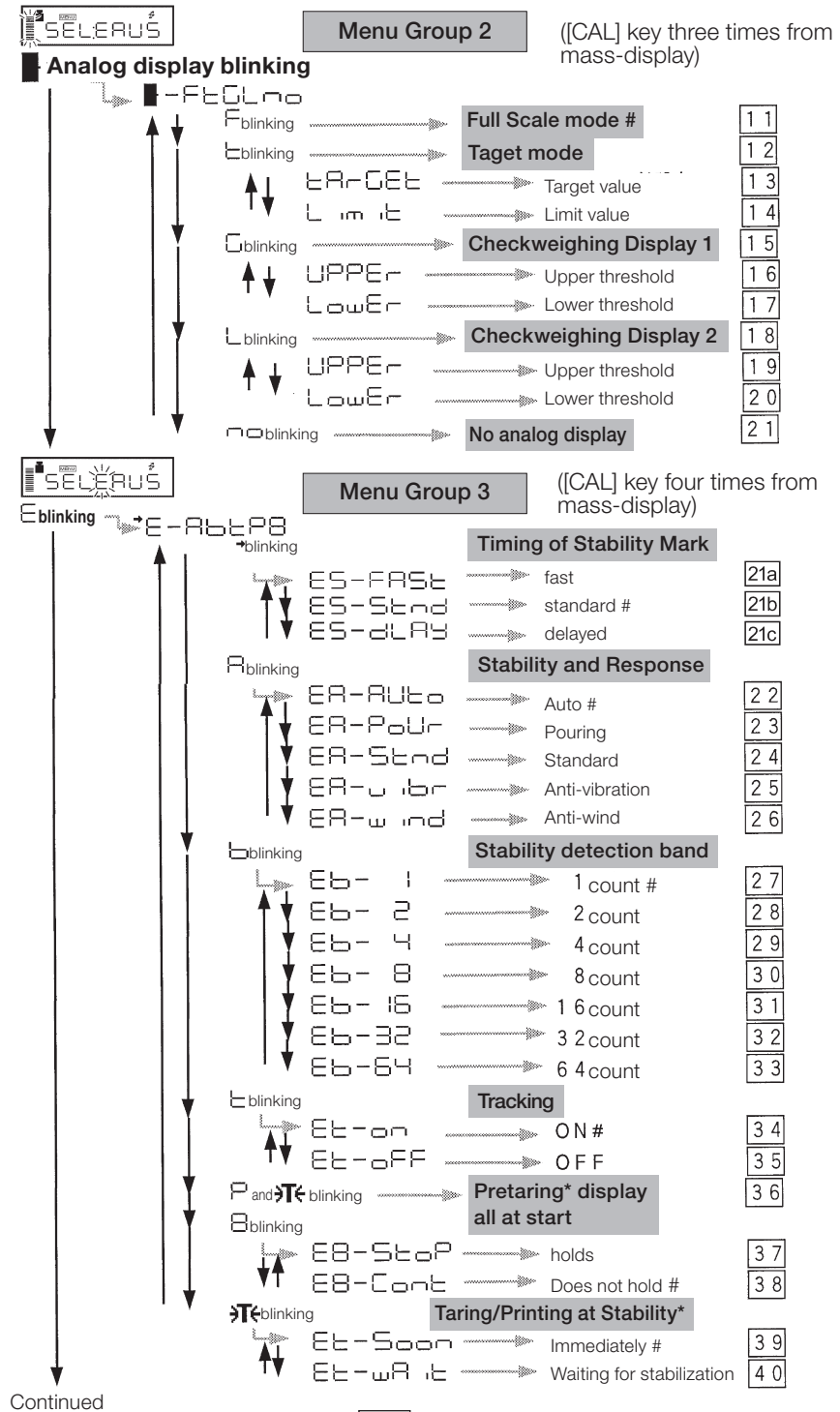

- [No.]: Menu item number
- #: Default settings

*Not applicable to a verified balance as a legal measuring instrument in using region

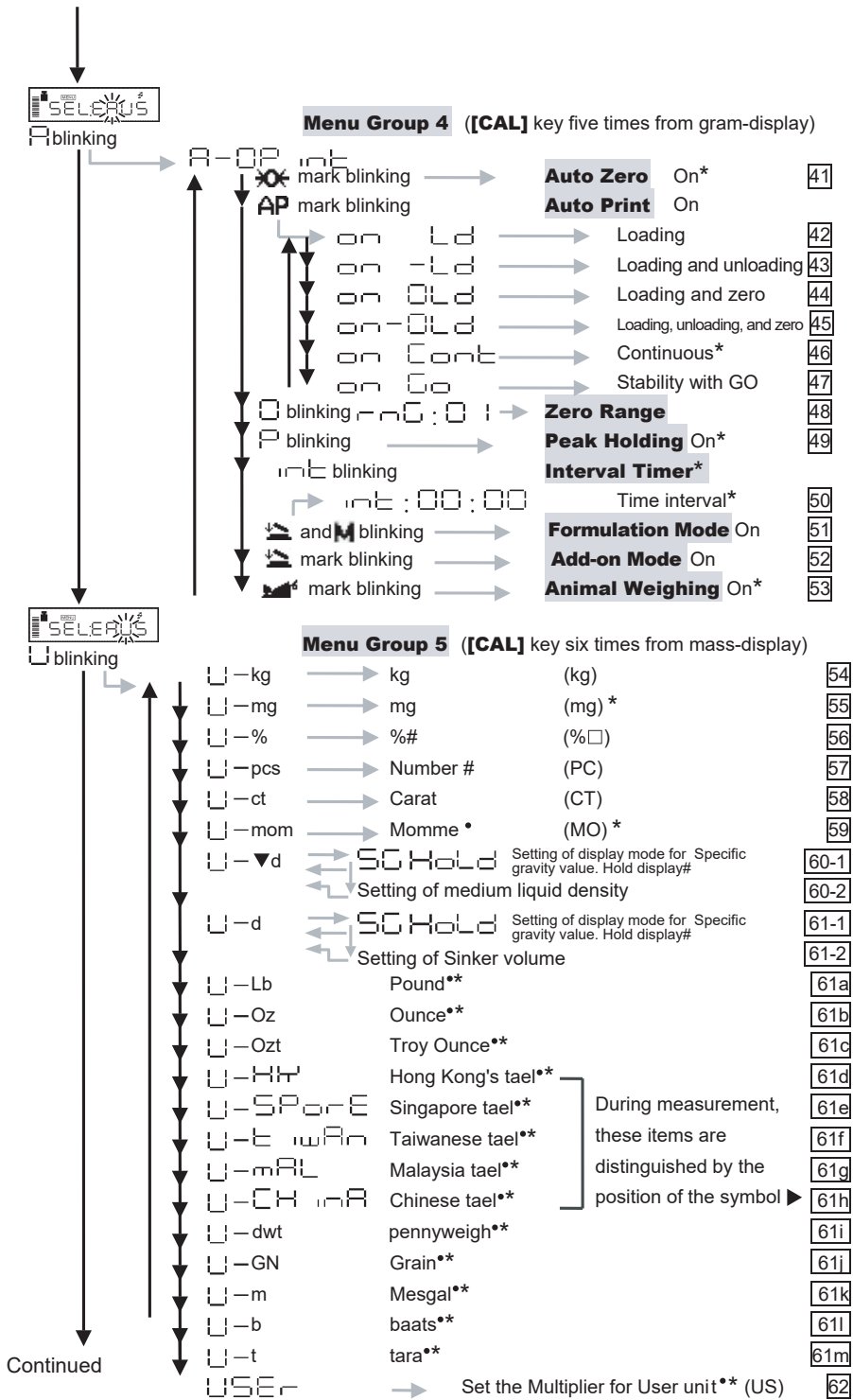

[No.] : Menu item number

: Default settings

• : These units cannot be selected in some countries due to legal restriction.

*Not applicable to a verified balance as a legal measuring instrument in using region

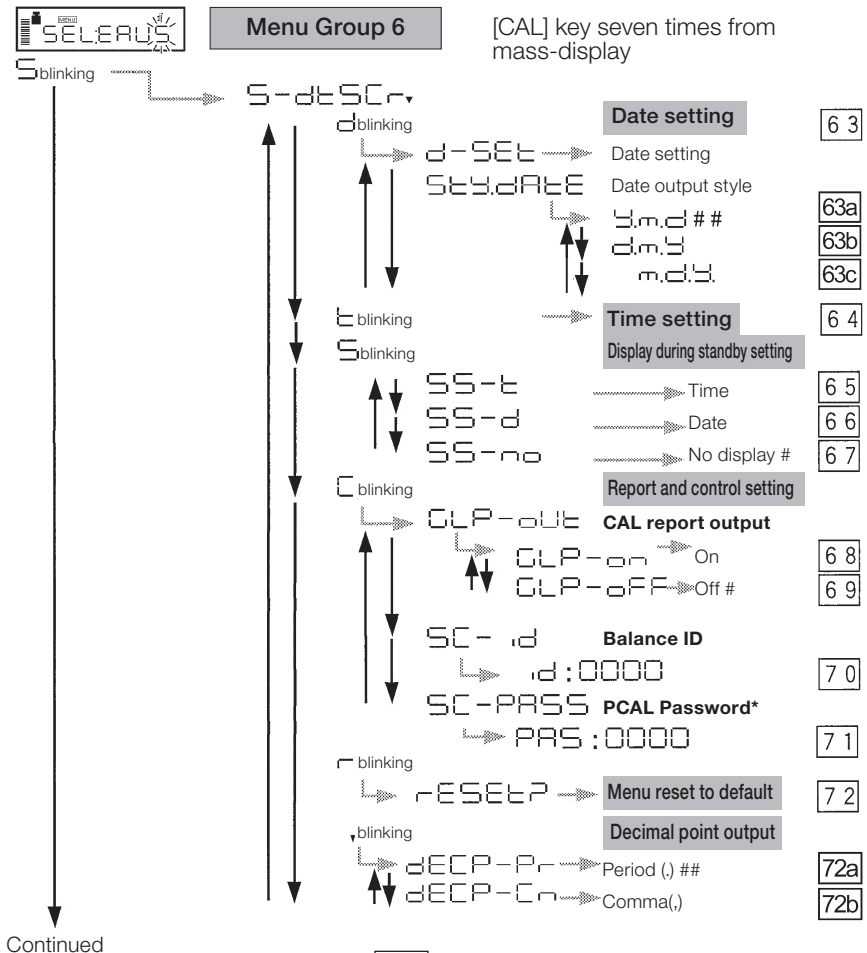

- [No.]: Menu item number
- #: Default settings. Settings are initialized to default by "Menu reset".
- ##: Default settings. Settings are not initialized to default by "Menu reset".

*Not applicable to a verified balance as a legal measuring instrument in using region

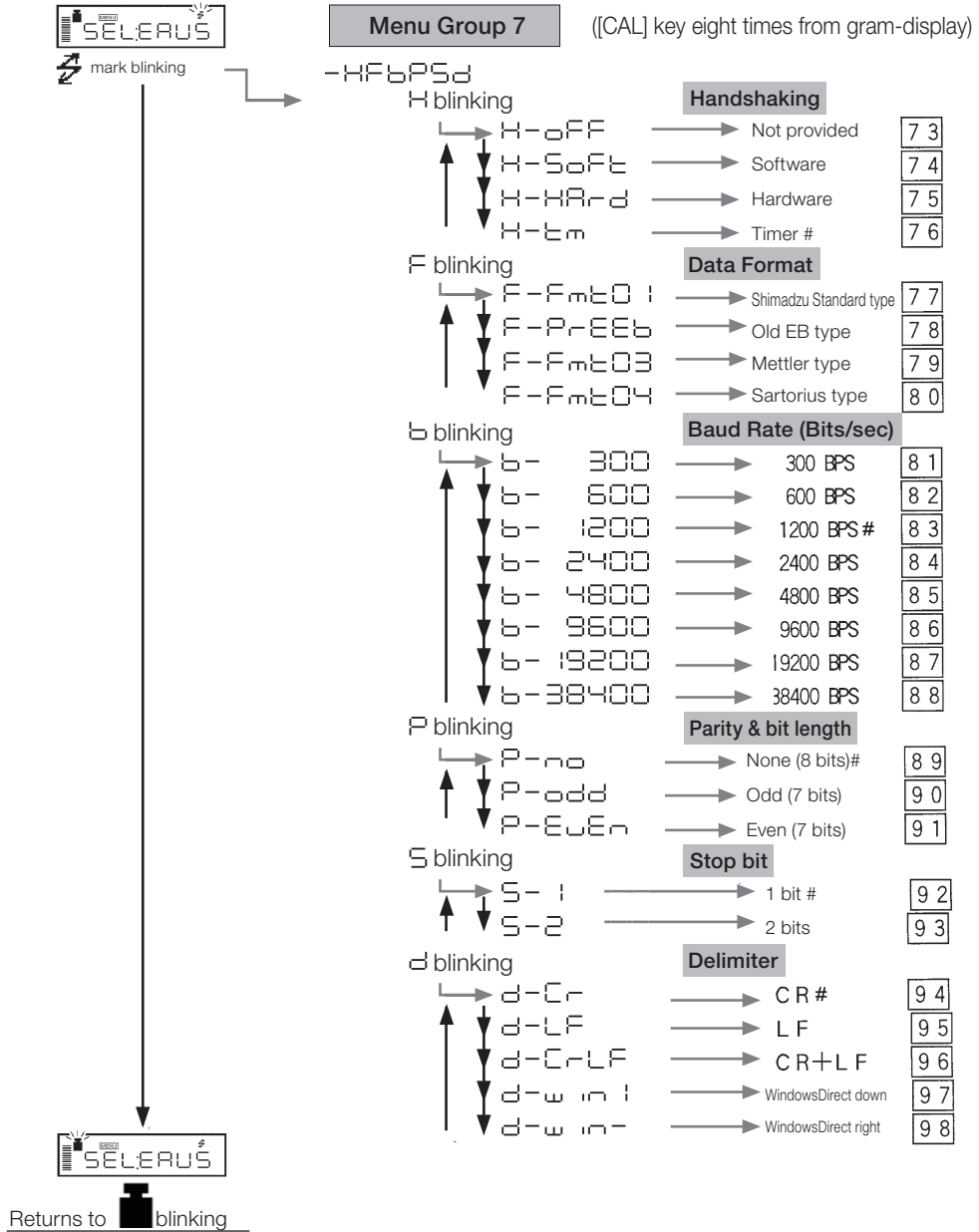

- [No.] : Menu item number
- #: Default settings

A-3. Standard Accessories and Maintenance Parts List

Item	Part number	Description
Pan (large pan)	S321-51555	
Pan (small pan)	S321-51556	
Pan supporter cap (for large pan)	S321-51552-02	
Pan supporter cap (for small pan)	S321-51552-01	
In-use protective cover	S321-62395	For display and key part
In-use protective cover (5 pieces)	S321-62395-10	For display and key part
Level screws	S321-53530-30	
Windbreak main	S321-62799-02	
Windbreak lid	S321-62798-10	
Windbreak fixing knob (1 piece)	S321-62787-02	2 pieces used
Windbreak Set	S321-62797-51	(Included as standard with small pan model) 1 each for 321-62799-02 and 321-62798-10
Windbreak for large pan	S321-74641-01	(Included as standard with large pan model)
Rubber cap (1 piece)	S321-62794	For small pan model, 2 pieces used
AC adapter	S321-73925	
Below-weigh hook cap	S321-51572-04	

A-4. Optional Accessories List

Item	Part number	Description
Printer EP-100	S321-73900-11	Impact dot print
Printer EP-110	S321-73900-12	Impact dot print, Includes LCD
Ionizer for electronic balance (static eliminator) STABLO-AP	S321-73700-01	Includes free holder, AC type
RS-232C Cable 25P-9P(1.5m)	S321-60754-01	
USB-Serial replacement kit	S321-62520-01	including Cable (S321-60754-01)
AKB-301 Application Keyboard	S321-53382-01	
Glass Windbreak WBC-102	S321-62795	For small pan model only (with three sliding doors)
Large Size Windbreak WBC-502	S321-53537	For all models
In-use protective cover (5 pcs) (for large pan 0.1g)	S321-61228	For large pan model minimum display 0.1 g only (protects the main body top surface in addition to the key switch and display)
In-use protective cover (3 pcs) (for large pan 0.01g)	S321-61228-02	For large pan model minimum display 0.01 g only (protects the main body top surface in addition to the key switch and display)
In-use protective cover (5 pcs) (for small pan)	S321-61229	For small pan model (protects the main body top surface in addition to the key switch and display)
Animal Bucket Set (for large pan 0.1g)	S321-62150	Small animal bucket (for large pan model minimum display 0.1 g only)
Animal Bucket Set (for large pan 0.01g)	S321-62150-51	Small animal bucket (for large pan model minimum display 0.01 g only)
Specific Gravity Measurement Kit SMK101A	S321-60576-51	for large pan model only, Weighing capacity reduction approximately 100g. Up to approximately 2 kg for weighing capacity
Specific Gravity Measurement Kit SMK-102	S321-60576-12	for small pan model only (except for UP223X, UP223Y), Weighing capacity reduction approximately 270 g
Remote Display RDB-201	S321-53600-01	With operation keys
Remote Display RDB-202	S321-53600-02	Without operation keys
Relay output interface IFB-RY1	S321-54026	RY1 connection cable required
RY1 connection cable	S321-62420	



Note

- Part number and specification are subject to change without notice.
- It is not guaranteed that RS-232C cable will conform to all computers. The lock screws may not be able to be fastened to the balance in some cases.
- Small pan types have weighing capacities of 1,020 g or less.
- Large pan types have weighing capacities of 2,200 g or more.

A-5. RS-232C/Specifications of Connectors

Caution

This connector includes an RS-232C signal cable. If using a commercially purchased RS-232C or other cable, make sure in advance that it is not connected to any pins other than RS or NC from the application column of the following tables. If full connection cables or any other cables which connect to pins other than the RS or NC are used, it could damage the balance, PC, or other equipment.

Note

NC = not connected inside balance, OC = open collector output
For signals other than RS, use an IFB-RY1 relay output interface (special accessory).

RS-232C Connector

Pin No.	Name	Function	Remarks
1	FG	Frame ground	
2	TXD	Data output	
3	RXD	Data input	
4	RTS	Internal connection with CTS	
5	CTS	Internal connection with RTS	
6	DSR	Handshake (receiving)	
7	SG	Signal grounding	
8	NC	Blank	
9	NC	Blank	
10	NC	Blank	
11	NC	Blank	
12	NC	Blank	
13	NC	Blank	
14	NC	Blank	
15	NC	Blank	
16	NC	Blank	
17	NC	Blank	
18	NC	Blank	
19	NC	Blank	
20	DTR	Handshake (transmission)	
21	NC	Blank	
22	NC	Blank	
23	NC	Blank	
24	NC	Blank	
25	NC	Blank	

KEY Connector
(When used for checkweighing output)

Pin No.	Name	Function	Remarks
1	GND	Ground of checkweighing	
2	OPERATION	Output during weighing	Checkweighing output is O.C. (open collector). (For photo-coupler drive) Allowable voltage: 5~24VDC Allowable current: 0~20mADC
3	STABLE	Output while balance display is stable.	
10	LO	LO signal output	
11	GO	GO signal output	
12	HIGH	HI signal output	
13	ZERO	Output while balance display is zero	Make sure to connect to external device end when using for checkweighing.
9	9-15		
15	Connect		

Concept of Open Collector Circuit

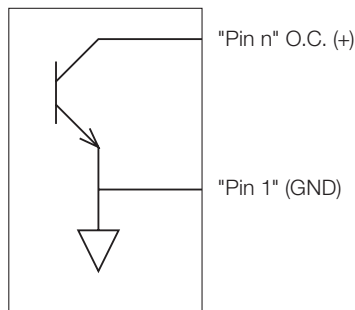

Balance internal circuit

A-6. Unit Conversion Coefficient List

Unit conversion is carried out using the following values on the UP Series.

1g

=0.001kg

=1000mg

=5ct

=0.266666667 mom

A-7. Performance Checks

Not applicable to a verified balance as a legal measuring instrument in using region





Notes

Performance checks should be conducted in a room where there are no sudden temperature changes.
 Refer to the installation guidelines for the environmental factors that assure optimal performance.

Repeatability

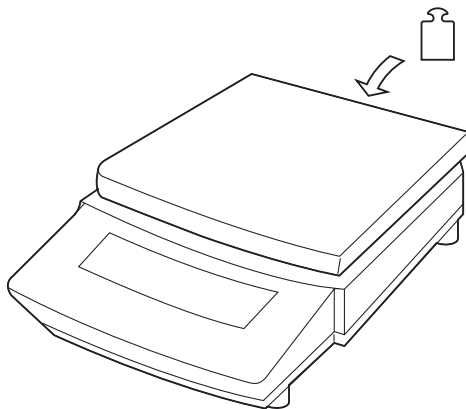
- 1** Allow the balance to warm up sufficiently by turning ON the power and leaving it at the gramdisplay at least two hours before starting the performance checks.
- 2** Choose a weight that is near half the capacity of the balance. Load and unload the weight five successive times and record the following items:
 Xi: Displayed value when the weight is loaded.
 Yi: Displayed value when the weight is unloaded.



 Load and unload a weight which is near the capacity of the balance five successive times.

Load: $X_1, X_2, \dots, X_i, \dots, X_5$

Unload: $Y_1, Y_2, \dots, Y_i, \dots, Y_5$

$$R_x = X_{\max} - X_{\min}$$

or

$$R_y = Y_{\max} - Y_{\min}$$

max is maximum value and min is minimum value.

- 3** Use the formulas shown below to calculate the values R_x and R_y .
- 4** Balance repeatability is considered normal when both R_x and R_y are within five counts. * One count corresponds to one minimum display unit of the balance model.

Cornerload Performance

- 1** Allow the balance to warm up sufficiently by turning ON the power and leaving it at the granddisplay at least two hours before starting the performance checks.

- 2** Move a weight that is approximately 1/4th of the weighing capacity on the pan in the order indicated by the numbers in the figure to the right and record the value of each as X1 through X5. If the difference between the readings at the center position and each of the off-center positions (eccentric error) is within five counts, the balance cornerload performance is considered normal.

- 3** If the differences (deviation error) between the average value of the two values at the center and the values for positions outside of the center are all within five counts, the cornerload performance is considered normal. One count refers to the balance reading limit (1 scale). The difference from the first center value can also be used as the deviation error instead of the average value of the two values at the center.

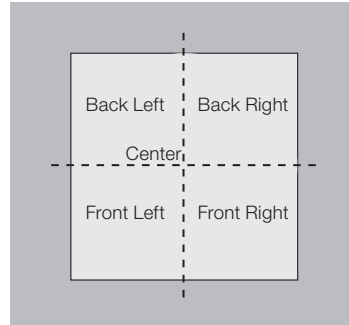

A-8. Below-Weigh Hook Dimensions

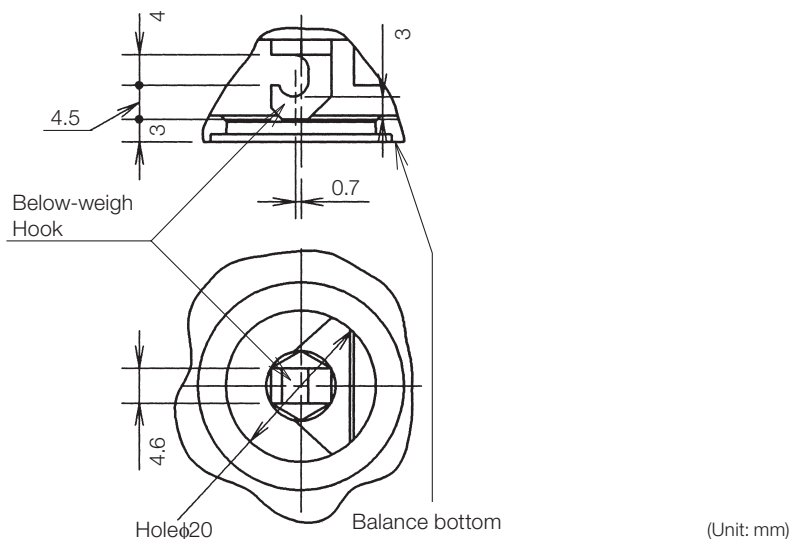

A-9. Index

A

AC adapter	7, 8, 15, 94, 95, 101
Administrator	40, 42
Ambient temperature	94, 95
Analog display	4, 49
Animal weighing	4, 70
Application keyboard	102
Automatic span calibration	39
Auto print	4, 53
Auto zero	55
Averaging	43

B

Bar graph display	30
Basic operation	19
Below-weigh hook	106
Built-in calibration weight	32
Built-in clock	28

C

Cable	79
Calibration check	31, 33, 36
Calibration mass → (See Calibration weight)	
Calibration report	42
Calibration weight	35, 36, 40
Checkweighing	49, 50, 54
Clock	28, 39
Clock-CAL Fully-automatic Calibration	39
Command code	82
Communication speed	88
Comparator	50
Computer	76
Connector	103

D

Data format	80
Date	28

Decimal point	89
Default setting	26
Delimiter	89
Delivery	7
Density	62
Display .. 1, 4, 20, 29, 30, 47, 48, 49, 50, 91, 92, 93	

E

Echo back	83
Electronic printer	75, 102
Environment	X, 43
Error display	20, 92
External weight	17, 35, 36

F

Format	80, 88
Formulation	73

G

GLP	42
GMP	42
Graphic display	23

H

Handshake	103
-----------------	-----

I

ID	42
Installation	IV, V, 5, 10
Interval timer	67
In-use protective cover	7, 8, 9, 101, 102
ISO9000	42

K

Key	3
-----------	---

L

Large pan model	1, 8, 12
Last menu recall	26
LCD	93

M

Maintenance	VI, VII, IX, 90, 101
Menu	21, 22, 26, 27, 52, 96
Menu group	23
Menu item selection	21, 22
Menu lock	27
Menu map	21, 96
Menu reset	26
Minimum display	30

N

Numerical value	25
-----------------------	----

O

Optional accessories	102
Output	28, 46, 53, 67, 89

P

Parity	88
Password	41
PCS	52
Peak hold	65
Percentage	48
Performance check	105
Peripherals → (See Optional accessories)	
Personal computer	76
Piece counting	52
Pouring mode	43
Pretare	58
Printing → (Also See "Output")	

R

Readability → (See Minimum display)	
-------------------------------------	--

Remote display	102
Response	43

S

Sensitivity adjustment → (See Span calibration)	
Small pan model	1, 9, 12
Span calibration	16, 17, 32, 35
Specification	94, 103
Specific gravity	59
Stability	4, 43, 45, 46, 57
Stability detection band	45
Stability mark	4, 46
standard accessories	101
Stand-by	4, 29
Stop bit	89

T

Target	49, 51
Taring	57
Time	29
Tracking	46
Transportation	90
Troubleshooting	91, 93

U

Unit	3, 20, 47, 104
Unit conversion	104
Unpacking	7

V

Vibration	5
-----------------	---

W

Weighing	19, 50
----------------	--------

Z

Zero range	56
Zero tracking	46

Shimadzu Corporation

SHIMADZU CORPORATION. International Business Department

3. Kanda-Nishikicho 1-chome, Chiyoda-ku, Tokyo 101-8448, Japan
Phone: 81(3)3219-5641 Fax: 81(3)3219-5710

SHIMADZU SCIENTIFIC INSTRUMENTS, INC.

7102 Riverwood Drive, Columbia, Maryland 21046, U.S.A.
Phone: 1(410)381-1227 Fax: 1(410)381-1222 Toll Free: 1(800)477-1227

SHIMADZU EUROPA GmbH

Albert-Hahn-Strasse 6-10, 47269 Duisburg, F.R. Germany
Phone: 49(203)7687-0 Fax: 49(203)7666-25

SHIMADZU (ASIA PACIFIC) PTE LTD.

79 Science Park Drive #02-01/08, CIntech IV Singapore Science Park I, Singapore 118264, Singapore
Phone: 65-6778-6280 Fax: 65-6779-2935

SHIMADZU SCIENTIFIC INSTRUMENTS (OCEANIA) PTY. LTD.

Units F, 10-16 South Street Rydalmere N.S.W. 2116, Australia
Phone: 61(2)9684-4200 Fax: 61(2)9684-4055

SHIMADZU SCIENTIFIC INSTRUMENTS (TAIWAN) CO., LTD.

11F, No. 37, Dongxing Rd., Xinyi Dist., Taipei City 11070, Taiwan
Phone: 886-2-8768-1880 Fax: 886-2-8768-1883

SHIMADZU DO BRASIL COMÉRCIO LTDA.

AV. Tambore, 576 - Tambore - Barueri, Brasil CEP 06.460-000
Phone: 55(11)2134-1677 Fax: 55(11)3611-2209

SHIMADZU (HONG KONG) LIMITED

Suite 1028 Ocean Center, Harbour City, Tsim Sha Tsui, Kowloon HONG KONG
Phone: (852)2375-4979 Fax: (852)2199-7438

SHIMADZU (CHINA) CO., LTD.

Block E, No.570 West Huaihai Road, Shanghai, 200052 P.R. of China
Phone: 86(21)2201-3888 Fax: 86(21)2201-3666

SHIMADZU MIDDLE EAST & AFRICA FZE

Warehouse No. RA08UC02, Jebel Ali, Dubai, P.O. Box 262081 United Arab Emirates
Phone: 971(4)883-6668 Fax: 971(4)883-6808

URL <https://www.shimadzu.com/>