

ELECTRONIC BALANCE

BL SERIES

**BL320S(L), BL620S(L),
BL3200S(L), BL220H(L),
BL320H(L), BL2200H(L),
BL3200H(L)**

INSTRUCTION MANUAL

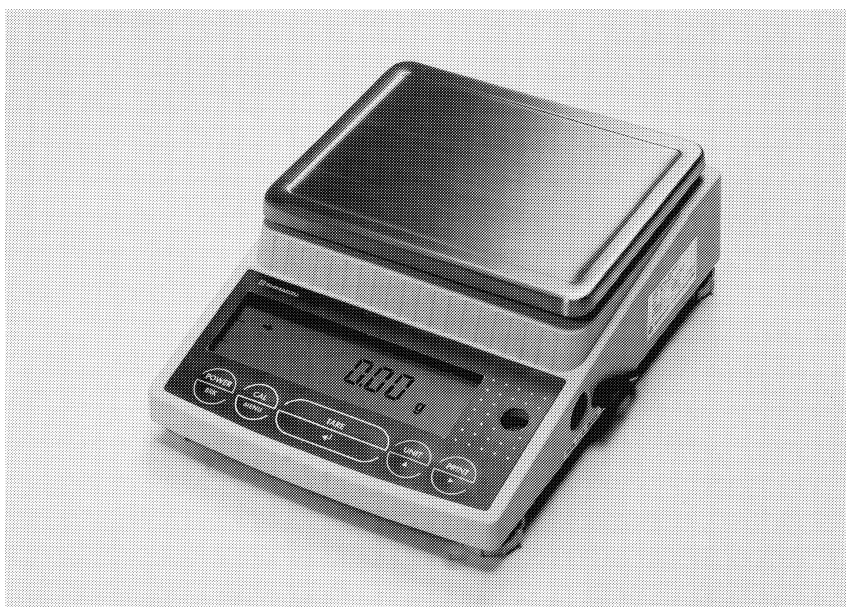

SHIMADZU CORPORATION
ANALYTICAL & MEASURING INSTRUMENTS DIVISION

KYOTO, JAPAN

ELECTRONIC BALANCE

BL SERIES

**BL320S(L), BL620S(L),
BL3200S(L), BL220H(L),
BL320H(L), BL2200H(L),
BL3200H(L)**

INSTRUCTION MANUAL

**READ AND UNDERSTAND THIS MANUAL BEFORE
OPERATION. SAVE THIS MANUAL.**

SHIMADZU CORPORATION
ANALYTICAL & MEASURING INSTRUMENTS DIVISION
KYOTO, JAPAN

Requests

- Provide this manual to the next user in the event that the instrument is transferred.
- To ensure safe operation, contact your Shimadzu Balance representative for installation, adjustment, or reinstallation after moving the instrument to a different site.

Notices

- The content of this manual is subject, without notice, to modifications for the sake of improvement.
- Every effort has been made to ensure that the content of this manual was correct at the time of creation. However, in the event that any mistakes or omissions are discovered, it may not be possible to correct them immediately.
- The copyright of this manual is owned by Shimadzu Corporation. Reproduction and duplication of whole or part of the content without permission of the company are strictly prohibited.

© 2000-2008 Shimadzu Corporation. All rights reserved.

Notation Conventions



Note

This instruction manual uses the following notation conventions to indicate Safety Precautions and additional information.



Caution

Indicates a potentially hazardous situation that may result in injury to personnel or equipment damage.





Note

Provides additional information needed to properly use the balance.



Safety Precautions To be strictly observed





To ensure that you use the balance safely and correctly, read the following precautions carefully and observe them.

The levels of danger and damage that will arise if the balance is used incorrectly are classified and indicated as shown below.

 WARNING	<p>Indicates a potentially hazardous situation which, if not avoided, could result in serious injury or possibly death.</p>	 CAUTION	<p>Indicates a potentially hazardous situation which, if not avoided, may result in minor to moderate injury or equipment damage.</p>
--	---	--	---

Precautions are classified and explained by using one of the symbols below, depending on the nature of the precaution.

 Instructions	<p>Indicates an action that must be performed.</p>	 Prohibitions	<p>Indicates an action that must NOT be performed.</p>
---	--	---	--

 WARNING	
 Prohibitions	<p>Never disassemble, modify or attempt to repair this product or any accessory.</p> <p>You could sustain an electric shock or the product could operate abnormally. If you believe that the balance has failed, contact your Shimadzu representative.</p>
 Instructions	<p>Use the balance with the specified power supply and voltage.</p> <p>Using the balance with an incorrect power supply or voltage will lead to fire or trouble with the balance. Note also that if the power supply or voltage is unstable or if the power supply capacity is insufficient, it will not be possible to obtain satisfactory performance from the balance.</p>
 Instructions	<p>Use the correct weighing units.</p> <p>Using incorrect weighing units can lead to accidents as a result of weighing errors. Check that the weighing units are correct before starting weighing.</p>
 Prohibitions	<p>Do not use the balance outdoors or anywhere where it will be exposed to water.</p> <p>You could sustain an electric shock or the product could operate abnormally.</p>

CAUTION



Prohibitions

Avoid locations where the balance will be exposed to any of the following.

This could cause accidents or poor performance.

- Air flow from an air conditioner, ventilator, door or window
- Extreme temperature changes
- Vibration
- Direct sunlight
- Corrosive or flammable gases
- Dust, electromagnetic waves or a magnetic field

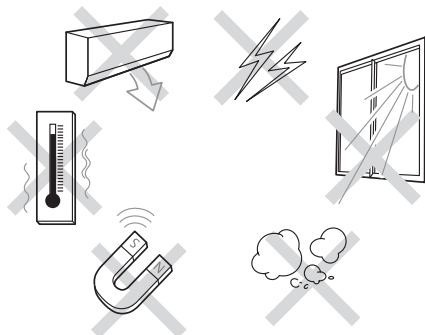

Instructions

Install the balance on a strong and stable flat table or floor.

Placing the balance in an unstable site could lead to injury or trouble with the balance. When selecting the installation site, take into account the combined weight of the balance and the item to be weighed.



Instructions

After a power outage, turn the power back ON.

When a power outage occurs, the power is shut off automatically. Therefore, begin operation from 2. INSTALLATION (4) (📖 page 4) again.



Instructions

Treat the balance with care and respect.

The balance is a precision instrument. Subjecting it to impacts could cause it to fail. When moving the balance, remove pan and pan supporter. Grasp it firmly with both hands to carry it.

If the balance has to be stored for a long time, store it in the packaging box in which it was delivered.



Prohibitions

Do not connect anything other than peripheral devices specified by Shimadzu to the balance's connector.

If you do, the balance may stop working normally.

In order to avoid trouble, always connect peripheral devices in accordance with the directions in this manual.



Instructions

If you detect anything abnormal (e.g. a burning smell) disconnect the AC adapter immediately.

Continuing to use the balance with an abnormality could lead to fire or an electric shock.

Action for Environment (WEEE)

To all user of Shimadzu equipment in the European Union:

Equipment marked with this symbol indicates that it was sold on or after 13th August 2005, which means it should not be disposed of with general household waste. Note that our equipment is for industrial/professional use only.

Contact Shimadzu service representative when the equipment has reached the end of its life.

They will advise you regarding the equipment take-back.

With your co-operation we are aiming to reduce contamination from waste electronic and electrical equipment and preserve natural resource through re-use and recycling.

Do not hesitate to ask Shimadzu service representative, if you require further information.



WEEE Mark

Declaration of Conformity

Manufacturer's Name: SHIMADZU CORPORATION
Analytical & Measuring Instruments Division
Address : 1, Nishinokyo-Kuwabara-cho, Nakagyo-ku,
Kyoto 604-8511, Japan

declares in sole responsibility that the following product

Product Name **Electronic Balance**
Model Name **BL series**
P/N **Depend on configuration. See Appendix 1.**

referred to in this declaration conforms with following directives and standards

EMC Directive 2004/108/EC

EN 55022:2006 (Class B)

EN 55024:1998 + amendment A1:2001 + amendment A2:2003

EN 61000-3-2:2000 + amendment A2:2005

EN 61000-3-3:1995 + amendment A1:2001 + amendment A2:2005

Low Voltage Directive 2006/95/EC

EN 60950:2001

The last two digits of the year in which CE marking was affixed for Low Voltage Directive 2006/95/EC are 03.

- Note 1) This declaration becomes invalid if technical or operational modifications are introduced without manufacturer's consent.
- Note 2) This declaration is valid if this product is used alone or in combination with the accessories of this product which are mentioned in attached Appendix 1 or other instruments which fulfill with the requirement of mentioned directive.
- Note3) Importer/Distributor and Authorised Representative in EU is as follows:
SHIMADZU EUROPA GmbH
Address :Albert-Hahn-Strasse 6-10, 47269 Duisburg, F.R. Germany

Quality Assurance Department
Analytical & Measuring Instruments Division



Appendix 1

Product Name : Electronic Balance

Model No.	P/N
With AC adapter	
BL-320S	321-61465-52
BL-620S	321-61465-53
BL-3200S	321-61465-55
BL-220H	321-61465-42
BL-320H	321-61465-43
BL-2200H	321-61465-44
BL-3200H	321-61465-45
Without AC adapter	
BL-320S	321-61465-32
BL-620S	321-61465-33
BL-3200S	321-61465-35
BL-220H	321-61465-22
BL-320H	321-61465-23
BL-2200H	321-61465-24
BL-3200H	321-61465-25

CONTENTS

1.	COMPONENTS AND THEIR NAMES.....	1
2.	INSTALLATION.....	3
3.	WARM-UP.....	4
4.	CAUTION NOTES.....	5
5.	MESURING PROCEDURE.....	5
6.	MENU SELECTION.....	6
6.1	Menu selection when “ <i>F u n c . S E L</i> ” is selected.....	8
6.2	Menu selection when “ <i>i n t F R C E</i> ” is selected.....	10
7.	SENSITIVITY CALIBRATION.....	11
7.1	Setting the value of sensitivity calibration weight.....	11
7.2	Sensitivity Calibration.....	13
8.	REGISTRATION, CANCEL, AND CHANGE OF UNIT.....	14
9.	% SETTING.....	15
10.	PCS (No. of pieces) SETTING.....	16
11.	PERFORMANCE CHECKS.....	17
12.	MAINTENANCE.....	18
13.	TROUBLESHOOTING.....	19
14.	SPECIFICATIONS.....	20
15.	PARTS LIST.....	21
16.	PERIPHERAL DEVICES.....	22
16.1	The EP-60A Electronic Printer.....	22
16.2	The IFB-102A RS-232C Interface.....	23
16.3	Input/output Format.....	25
16.4	Command Code.....	26
17.	Detailed Information on Unit Conversion.....	27

1. COMPONENTS AND THEIR NAMES

Components

Included with every balance are one of the following items.

- Balance body
- Pan
- Inspection certificate
- AC adapter (option)
- Pan supporter
- Breeze guard (Only type, BL220H (L) and BL320H (L)).
- protection cover
- Instruction manual

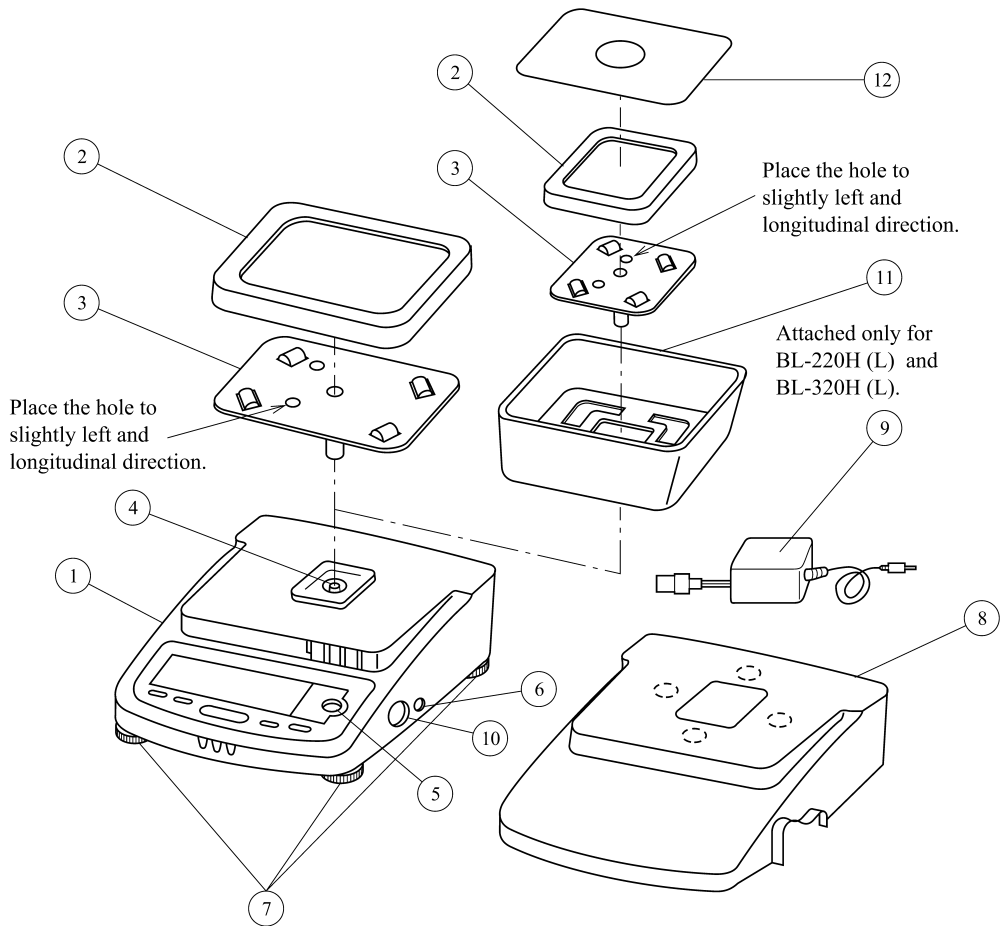

- | | | |
|---|---|-----------------------|
| ① Balance body | ② Pan | ③ Pan supporter |
| ④ Pan shaft | ⑤ Level gauge | ⑥ Power jack |
| ⑦ Level screws (3 places) | ⑧ Protection cover | ⑨ AC adapter (option) |
| ⑩ Data I/O connector | ⑪ Breeze guard (Only BL220H (L) and BL320H (L)) | |
| ⑫ Breeze guard cover (Only BL220H (L) and BL320H (L)) | | |

Display and keypad

Display

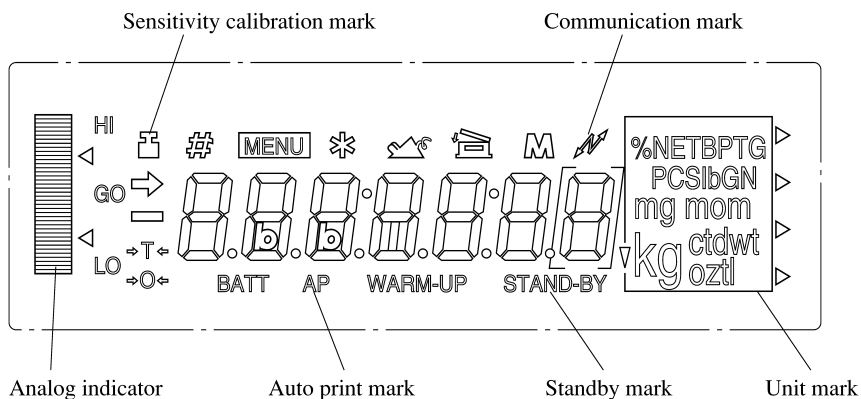

Keypad

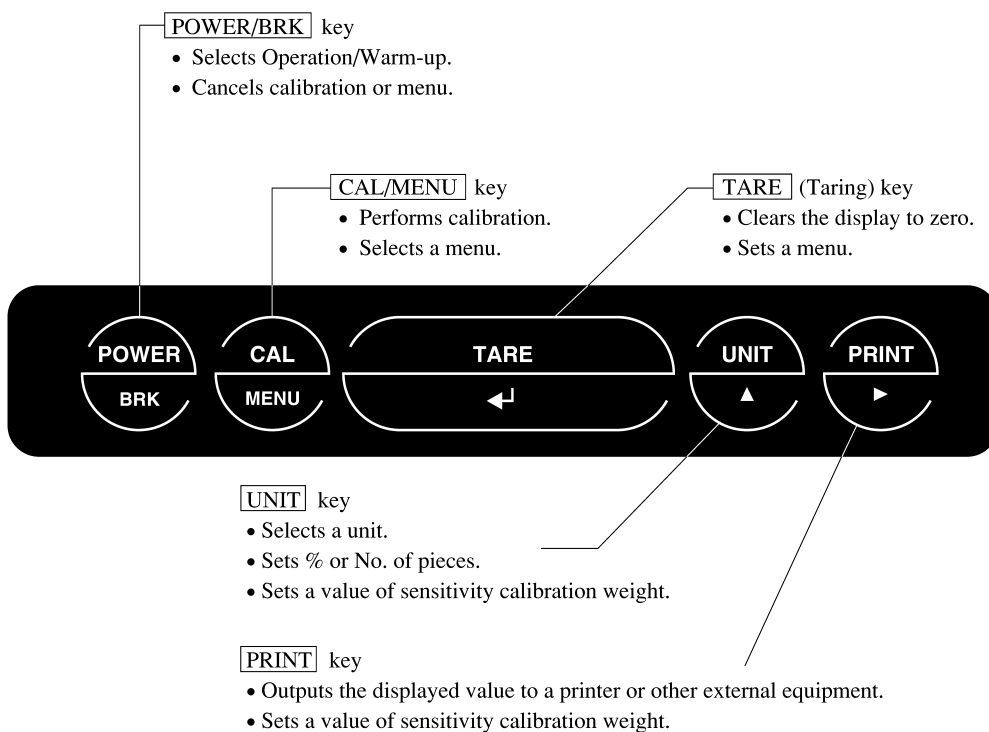

2. INSTALLATION

Check power voltage

 **Caution**

 **Caution**

 **Caution**

 **Caution**

 **Caution**

Installation site

 **Caution**

 **Note**

 **Note**

 **Note**

Installation (1)

(2)

- Use only the AC adapter that supplies the output of 12VDC or the AC adapter provided by the distributor who is authorized by Shimadzu Corporation.
- Check the power supply voltage.
- Check that the supplied power voltage satisfies the displayed value on the AC adaptor.
- In order to prevent electric shock when connecting the power, use a 3P plug with a grounding line or a 2P plug after connecting the grounding wire to the screw at the back of the case.
- Do not place anything that makes it difficult to pull the AC adapter off the outlet.

Avoid installing the balance in a place where:

- It is exposed to corrosive gas or flammable gas;
- It is exposed dust, wind, vibration, electromagnetic waves, or a magnetic field;
- It is exposed to direct sunlight or a sudden change in temperature; or
- It is exposed to extremely high or low temperature or humidity.

Remove the protection seals (4 places) from the protection cover and then put it on the balance body.

Turn the level screw so that the air bubble on the level gauge is positioned at the center of the red circle. Make sure that the balance never jolt.

For easy adjustment, insert the level

screw on the right back forcibly to the balance body. Then while lightly pressing the balance top with your hand, adjust the horizontal level with the level screws on the right front and left front.

Finally, in order to make the balance stable, adjust the right back screw to touch the floor.

This procedure allows you to level the balance quickly.

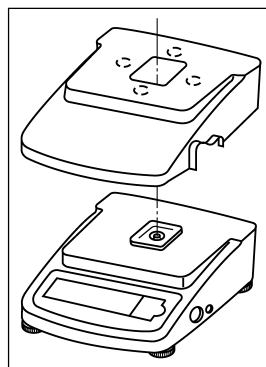

- (3) Place the pan supporter on the pan shaft and then the pan on the pan supporter.
- (4) Plug the AC adapter into the outlet.
The balance shows *o F F* after self-checking.
- (5) Press the **POWER/BRK** key. All displays light for one minute. Then the display automatically shows "zero" and the balance enters measurement ready state.
- (6) Press the **POWER/BRK** key again. The standby mark lights up and the balance enters standby state.
- (7) Warm up the balance.
- (8) Calibrate the sensitivity. Refer to "7. SENSITIVITY CALIBRATION".
- (9) Check the performance. Refer to "11. PERFORMANCE CHECKS"

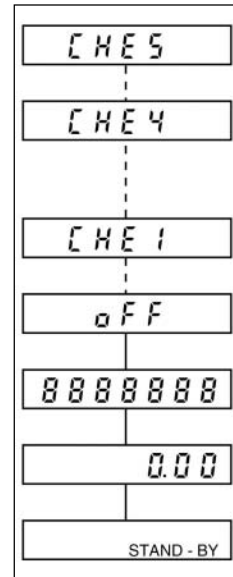

3. WARM-UP

- Apply power in advance for one hour or more. This will allow you to immediately make an accurate measurement.
- Even if the balance is not used, keep the standby mark lit (warm-up state) by pressing the **POWER/BRK** key without disconnecting the AC adapter.
- If the balance is not used for one month or more, disconnect the AC adapter.

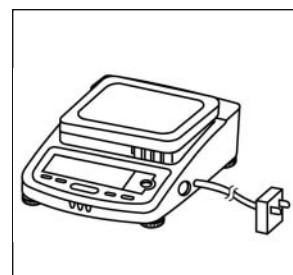

4. CAUTION NOTES

Do not.....

- put water, metal pin or any thing in the balance;
- open the balance case;
- leave anything exceeding the weighing capacity on the pan;
- expose the balance to anything magnetized;
- connect anything other than the specified equipment to the connector on the rear side of the balance; and.
- give a shock to the pan.

5. MEASUREMENT PROCEDURE

Preparation for Weighing

Making a measurement mode

- (1)
- (2)

Warm up the balance.

Press the POWER/BRK key. The standby mark goes off and all displays light. Check that there is no segment which is not lit.

The balance shows zero and enters the measurement mode

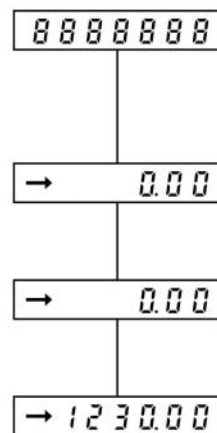

Measurement

- (1)
- (2)
- (3)

When using a tare, load the tare on the pan and press the TARE key after a stability mark is lit.

Check that the display shows zero.

Load a sample. When the stability mark is lit, read the display. If the total mass of the sample and tare exceeds the weighing capacity, oL will be displayed.

- Tare..... A sample container or other.
- Stability mark (→)..... Lights when the displayed value falls within the stability band. When the load change is slow, the displayed value will fluctuate with the stability mark lit.

6. MENU SELECTION

This balance is designed to permit selection of the measuring conditions to compensate for vibration and other conditions present at the installation site. This feature permits greater weighing efficiency and accuracy, and is referred to as “Menu Selection”.

Also in BL series, setting the balance to “*Standard*” (standard measurement mode) makes a normal measurement and requires no other setting.

The menu in the BL series consists of three classifications. Basically press the **TARE** key to go to lower hierarchy, and press the **POWER/BRK** key to return to upper hierarchy. Continuously pressing the **POWER/BRK** key returns the display to weight display from each hierarchy with single operation.

- | | |
|-------------|---|
| Step | <p>(1) Press the CAL/MENU key during the weight display.</p> <p>(2) “<i>CAL</i>” will be displayed.</p> <p>(3) Every time the CAL/MENU key is subsequently pressed, the display be changed in the order shown below.</p> <p>(4) Select the desired condition and press the TARE key. Then, it will be set or enter into the lower hierarchy.</p> |
|-------------|---|

0.000	Weight display
CAL	Sensitivity calibration mode
St b S t	Currently set condition
St n d	Standard mode
S A m P L E	Sample pouring mode
H i - S t b	High stability mode
F u n c. S E L	Enters second hierarchy menu. Advanced measurement, unit registration, and individual setting mode ⇒ Refer to Section 6.1 “Menu selection when “ F u n c. S E L ” is selected”.
C A L S E t	Enters second hierarchy menu. Setting the value of sensitivity calibration weight ⇒ Refer to Section 7.2 “Setting the value of sensitivity calibration weight”.
i n t F A C E	Enters second hierarchy menu. Input/output format setting mode ⇒ Refer to Section 6.2 “Menu selection when “ i n t F A C E ” is selected”.
0.000	Weight display

- If the measurement is done at severe measurement environment and the stability of the display is not so good, set the balance to “ H i - S t b ” (high-stability mode).
- When the high-speed sample pouring mode is executed, or the small amount of sample pouring is done, set the balance to “ S A m P L E ” (sample mode).

6.1 Menu selection when "Func. SEL" is selected

Pressing the TARE key when the "Func. SEL" is displayed at 1st hierarchy menu enters 2nd hierarchy menu.

In this menu, ON/OFF of zero tracking, setting the stability detection band, registration/cancel of unit, ON/OFF of auto print, and ON/OFF of analog display are made.

Key operation and each setting are made as follows.

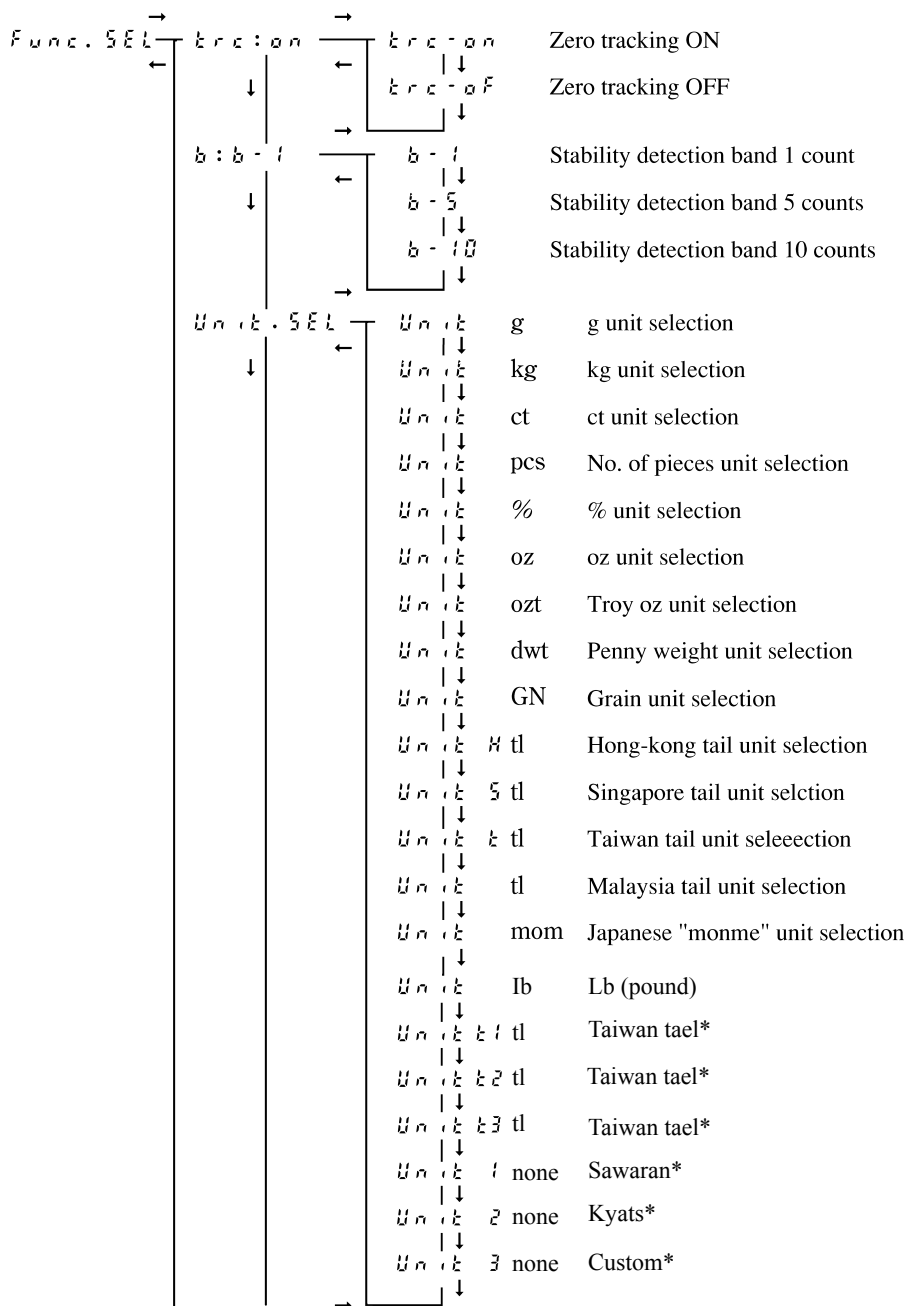

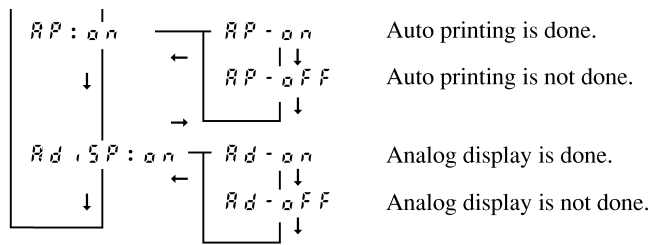

(→) : Press the **TARE** key.

(←) : Press the **POWER/BRK** key.

(↓) : Press the **CAL/MENU** key.

- When set to **b - 1**, satisfactory for most use, the stability mark lights when the display stays within +/-1 unit (the resolution value of the balance) for a fixed period time.
- When the display shows “**t r c **: b : b - *, AP **: Ad, SP **:**”, the currently set conditions are displayed on **.
- Zero tracking eliminates zero drift, and should be on (**t r c - on**) for normal weighing. When measuring weight changes over time, or when slowly adding a liquid or powder to the balance, turn off (**t r c - off**) the zero tracking feature.

* It can be selected in special Area only.

6.2 Menu display when *intFACE* is selected

Pressing the TARE key when the “*intFACE*” is displayed at 1st hierarchy menu enters 2nd hierarchy menu.

In this menu, the input/output format can be set.

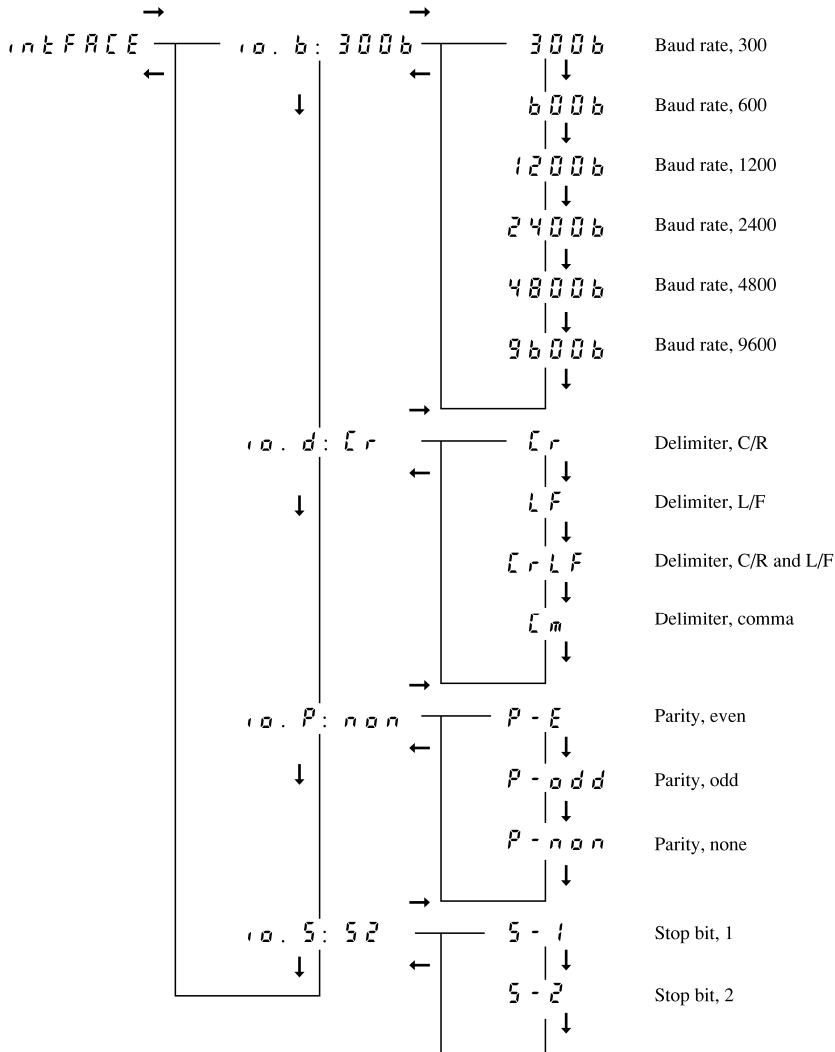

- (→) : Press the TARE key.
- (←) : Press the POWER/BRK key.
- (↓) : Press the CAL/MENU key.

- When the display shows “*io.b* :**, *io.d* :**, *io.P* :**, *io.S* :**”, the currently set conditions are displayed on **.

7. SENSITIVITY CALIBRATION

The electronic balance measures mass by electronicity compensating for terrestrial gravitation. Since gravitation varies slightly in different regions, span calibration (sensitivity calibration) is required when the balance is installed. Temperature also effects balance accuracy, and calibration must be performed whenever a significant change occurs. It is good practice to calibrate the balance whenever the balance is moved or unexpected shock is applied to the balance such that an article drops on the pan.

7.1 Setting the value of sensitivity calibration weight

In this balance, the value for sensitivity calibration weight can be set freely within the specified range. Using the weight having known value, sensitivity calibration can be made.

Set the weight value using at sensitivity calibration as follows.

- | | | |
|-------------|------------|--|
| Step | (1) | Following the menu selection, press the CAL/MENU key to make the display “CAL SET”. |
| | (2) | Press the TARE key to set the balance to weight set mode. |
| | (3) | The weight value currently set is displayed and the digit to be set blinks. When the weight value is not changed, press the TARE key. |
| | (4) | Pressing the PRINT key shifts the blinking digit. |
| | (5) | Pressing the UNIT key counts up the blinking displayed value. |
| | (6) | Repeats the steps (4) and (5) to set the weight value. |
| | (7) | When aborting the setting, press the POWER/BRK key. Then “Abort” is displayed for several seconds, the balance stops the setting of weight value and returns to weight display. |

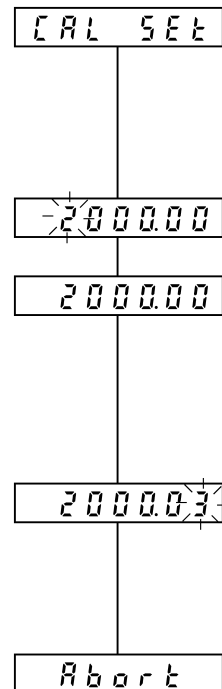

- (8) After the setting of weight value is completed, press the TARE key.
- (9) “ 5 E t ” is displayed for several seconds and the balance returns to weight display.
- (10) When setting the weight value exceeding the specified range, “ E r r 2 0 ” is displayed and then the balance returns to weight display.
- The settable weight value is follows.

BL320S (L)	More than 150g and less than weighing capacity	BL320H (L)	More than 150g and less than weighing capacity
BL620S (L)	More than 300g and less than weighing capacity	BL2200H (L)	More than 1000g and less than weighing capacity
BL3200S (L)	More than 1500g and less than weighing capacity	BL3200H (L)	More than 1500g and less than weighing capacity
BL220H (L)	More than 100g and less than weighing capacity		

7.2 Sensitivity Calibration

Perform the sensitivity calibration as follows.

- | | | | |
|-------------|--|--|--|
| Step | | <p>(1) Warm up the balance well. Refer to “3. WARM-UP”.</p> <p>(2) Check leveling.</p> <p>(3) Unload the sample on the pan and press the TARE key to zero the display.</p> <p>(4) Following the menu selection, press the CAL/MENU key to display “CAL”.</p> <p>(5) Press the TARE key to start the sensitivity calibration.</p> <p>(6) The set weight value appears and blinks.</p> <p>(7) Make sure that the stability mark is lit.</p> <p>(8) Place the calibration weight on the pan. At this time, the stability mark will once disappear.</p> <p>(9) When the stability mark is lit again, press the TARE key.</p> <p>(10) The display shows zero and blinks. Make sure that the stability mark is lit.</p> <p>(11) Unload the weight.</p> <p>(12) When the stability mark is lit again, press the TARE key.</p> <p>(13) “CAL End” is displayed for several seconds and the balance returns to weight display. This completes the sensitivity calibration.</p> <p>(14) If the different weight is used for this sensitivity calibration, “CAL E4” is displayed for several seconds and the balance returns to weight display. Check the weight and retry the sensitivity calibration.</p> | |
|-------------|--|--|--|

8. REGISTRATION, CANCEL, AND CHANGE OF UNIT

Step for

registration (1)

Press the **CAL/MENU** key and select the *F u n c . S E L* display.
(Press the **TARE** key.)

(2)

Press the **CAL/MENU** key and select the *U n i t . S E L* display.
(Press the **TARE** key.)

(3)

The registrable unit is displayed by every pressing the **CAL/MENU** key. The registerable units are three kinds which are selected from the following 14 kinds.

g, kg, ct, pcs, %, oz, ozt, dwt, GN, Hong-kong tail, Singapore tail, Taiwan tail, Maraysia tail, and Japanese "monme"

However, % and pcs (No. of pieces) cannot be registered simultaneously. The stability mark is lit on the unit display currently registered.

(4)

Press the **TARE** key on the unit display to be registered. That unit is registered.

When three kinds of unit are already registered, a new registration deletes the oldest registration among the three registered units. However, % and pcs (No. of pieces) cannot be registered simultaneously. Then deletes unnecessary one.

(5)

Continuously pressing the **POWER/BRK** key returns the display to weight display.

Step for cancel (1)

Carry out the same operation described (1) to (3) above to set unit display. Selecting the same one of the unit display which is currently registered (stability mark is lit) cancels the registration.

Step for change (1)

Pressing the **UNIT** key changes the unit which is already registered.

However, even if the unit of % and pcs is already registered, the display does not change to this unit unless making a setting of reference value.

9. % SETTING

This balance serves percent (%) display by setting the reference sample to 100%.

- | | | | |
|-------------|------------|--|---|
| Step | (1) | Register the % unit. (Refer to “8. Registration, cancel, and change of unit”). | <div style="border: 1px solid black; padding: 2px; display: inline-block;">0.000</div> |
| | | When % unit has been already registered, it is not necessary to register again. | |
| | (2) | Place the tare on the pan and press the TARE key. | <div style="border: 1px solid black; padding: 2px; display: inline-block;">5 E t 100%</div> |
| | (3) | Load the reference sample. | <div style="border: 1px solid black; padding: 2px; display: inline-block;">5 E t</div> |
| | (4) | Continuously press the UNIT key to display “ 5 E t 100% ”. | |
| | (5) | After the stability mark is lit, press the TARE key. | <div style="border: 1px solid black; padding: 2px; display: inline-block;">E r r 2 0</div> |
| | (6) | “ 5 E t ” is displayed for several seconds and the balance enters the % unit display.
Minimum displayed value changes as follows depending on reference sample weight (REF.)
Reference sample weight (REF.) is count value which minimum displayed value rearranges one count.
If the % conversion is not possible, “ E r r 2 0 ” is displayed for several seconds and the balance returns to weight display. | |

Type H

REF. < Minimum displayed value × 100	% conversion impossible
Minimum displayed value × 100 < REF. < Minimum displayed value × 1000	100%
Minimum displayed value × 1000 < REF. < Minimum displayed value × 10000	100.0%
Minimum displayed value × 10000 < REF. < Minimum displayed value × 100000	100.00%
Minimum displayed value × 100000 < REF.	100.000%

Type S

REF. < Minimum displayed value × 100	% conversion impossible
Minimum displayed value × 100 < REF. < Minimum displayed value × 1000	100%
Minimum displayed value × 1000 < REF. < Minimum displayed value × 10000	100.0%
Minimum displayed value × 10000 < REF.	100.00%

10. PCS (No. of pieces) SETTING

This balance can perform No. of pieces measurement (unit PCS).

No. of standard pieces is 10 pcs, 20 pcs, 50 pcs, or 100 pcs. When the No. of pieces is increased, the accuracy is improved.

- | | | | |
|-------------|------------|--|--|
| Step | (1) | Register the PCS unit following the unit registration. (Refer to “8. Registration, cancel, and change of unit”).

When PCS unit has been already registered, it is not necessary to register again. | <div style="border: 1px solid black; padding: 2px; width: fit-content; margin: 0 auto;">0.000</div> <div style="border: 1px solid black; padding: 2px; width: fit-content; margin: 0 auto;">Set 20^{PCS}</div> |
| | (2) | Place the tare on the pan and press the TARE key. | <div style="border: 1px solid black; padding: 2px; width: fit-content; margin: 0 auto;">Set</div> |
| | (3) | Load the standard sample with required pieces. | <div style="border: 1px solid black; padding: 2px; width: fit-content; margin: 0 auto;">Err 20</div> |
| | (4) | Check that the stability mark is lit. | |
| | (5) | When pressing the UNIT key continuously, the display will change as follows:

“ Set 10 ^{PCS} ”, “ Set 20 ^{PCS} ”,
“ Set 50 ^{PCS} ”, and “ Set 100 ^{PCS} ” | |
| | (6) | Select the desired PCS display and press the TARE key. | |
| | (7) | “ Set ” is displayed for several seconds and the balance enters the PCS unit display.

When the reference sample weight is less than “readability x No. of set pieces”, the PCS setting is not made.

In this case, “ Err 20 ” is displayed for several seconds and the balance returns to weight display. | |

11. PERFORMANCE CHECKS

Conduct performance checks in a room where the temperature does not change suddenly. These checks are used to determine if the balance conforms to specifications, and should be performed with the greatest care.

Preparation

- Warm up the balance well.
- Set the measurement condition as follows:
 - *S t a n d*
 - *b - 1*
 - *t r c - o f f*

Repeatability

(1)

Load and unload 10 successive times, an weight which is near the capacity of the balance. Then record the following items:

X_i : Displayed value when the weight is loaded after stability mark is lit.

Y_i : Displayed value when the weight is unloaded after stability mark is lit.

(2)

Calculate the standard deviation of σ_x and σ_y using the formulas shown right.

(3)

Balance operation is normal when the standard deviation is less than 1.5 times the value specified.

$\text{Load} : X_1, X_2, \dots X_i, \dots X_{10}$
 \downarrow
 $\text{Unload} : Y_1, Y_2, \dots Y_i, \dots Y_{10}$

$$\sigma_x = \sqrt{\frac{\sum_{i=1}^{10} (X_i - \bar{X})^2}{9}}$$

or

$$\sigma_y = \sqrt{\frac{\sum_{i=1}^{10} (Y_i - \bar{Y})^2}{9}}$$

where \bar{X}, \bar{Y} : Average value

Eccentric error

(1)

Prepare a sample which weights approximately 1/4 of the balance capacity and move it on the pan in the order as shown right. Record the results of X1 to X5 in this order.

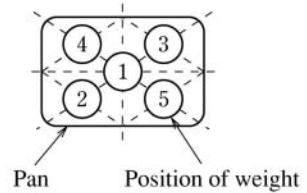

(2)

If the difference (eccentric error) between readings at the center position and the off center positions is as follows:

BL320H (L), 3200H (L), : 7counts

BL H series: 4 counts

BL S series: 2 counts

12. MAINTENANCE

When fouled:

- When the balance becomes dirty, wipe it off using a soft cloth with a small amount of mild detergent.
- Organic solvents or chemical dusters should not be used as they may damage painted surfaces and the display panel.
- When the balance is placed in a dusty or dirty environment, use the protection cover of standard accessory.
- The pan can be washed with water. Dry the pan sufficiently and mount to the balance.

13. TROUBLESHOOTING

For countermeasures having an asterisk, contact the nearest Shimadzu sales or service center.

When	What trouble	Cause -> Countermeasure
Before weighing	<ul style="list-style-type: none"> • Nothing is displayed by connecting the AC adapter to the outlet. • E r r 0 5 is displayed. 	<ul style="list-style-type: none"> • The AC adapter is disconnected. • The electrical board is turned OFF. • There is an internal error in the balance. => *
During weighing	<ul style="list-style-type: none"> • o L is displayed. • - o L is displayed. • The display fluctuates. • The display does not change from zero even if a sample having the weight near readability is loaded. • The display slowly changes when small amount of sample is loaded. (Normal: readability/1 sec.) • o F F has appeared suddenly. • Data communication cannot be made. 	<ul style="list-style-type: none"> • The mass on the pan is too heavy. • Sensitivity is not correct. • The pan or the pan supporter is not in place. • Influence from vibration or wind => Improve the installation site. => Change the measurement mode to High-stability mode. • Influence from electric noise or electromagnetic wave => Maintain a proper distance from the noise source. • Zero tracking works. => Refer to "6. Menu Selection". • The averaging processing is in High-stability mode. => Change the measurement mode if necessary. • There has been an instantaneous power failure. => Press the POWER/BRK key (the balance enters weight display mode). • Setting of communication parameter is wrong. => Refer to "16.4 Setting the input/output format". • Wiring of RS-232C cable is wrong.
During PCS or % setting	<ul style="list-style-type: none"> • E r r 2 0 has displayed. 	<ul style="list-style-type: none"> • Set value exceeds the specified range. => Refer to "9. % setting" and "10. PCS setting".
During sensitivity calibration	<ul style="list-style-type: none"> • Does not proceed to next step. (The stability mark does not light) • C A L E 4 has displayed. 	<ul style="list-style-type: none"> • Influence from vibration or wind => Improve the installation site. => Change the measurement mode to High-stability mode. • The weight used for sensitivity calibration is wrong. => Check the weight and retry the sensitivity calibration. • There is an internal error in the balance. => *

14. SPECIFICATIONS

Model	BL320S (L)	BL620S (L)	BL3200S (L)
Weighing capacity	320g	620g	3200g
Readability	0.01g	0.01g	0.1g
Standard deviation	0.006g	0.01g	0.06g
Linearity	0.01g	0.02g	0.1g
Calibration weight ^(*)	200g 300g	500g 600g	2000g 3000g
Pan diameter (mm)	100×100	160×124	
Main body size (mm)	Approx. 170 (W)× 240 (D) × 75 (H) mm		
Main body weight	Approx. 2.2 kg		
Stability of sensitivity (10°C - 35°C)	±10ppm/°C		
Applicable temperature range	5~40°C		
Power supply	AC adapter: 100~250VAC, 47~63Hz, Balance : 12VDC, 0.1A ^(*)		

Model	BL220H (L)	BL320H (L)	BL2200H (L)	BL3200H (L)
Weighing capacity	220g	320g	2200g	3200g
Readability	0.001g		0.01g	
Standard deviation	0.001g		0.01g	
Linearity	0.002g	0.003g	0.02g	0.03g
Calibration weight ^(*)	200g	300g	2000g	3000g
Pan diameter (mm)	100×100 (With the guard)		160×124	
Main body size (mm)	Approx.170 (W)×240 (D)×114 (H) mm		Approx. 170 (W) ×240 (D)×75 (H) mm	
Main body weight	Approx. 2.2 kg			
Stability of sensitivity (10°C - 35°C)	±3ppm/°C	±5ppm/°C (10~30°C)	±3ppm/°C	±5ppm/°C (10~30°C)
Applicable temperature range	5~40°C			
Power supply	AC adapter: 100~250VAC, 47~63Hz, Balance : 12VDC, 0.1A ^(*)			

*1 : Refer to “7.1 Setting the Sensitivity Calibration Weight”.

*2 : 12VDC, 1A FOR BL-L (Backlight Type)

15. PARTS LIST

Optional accessories

Peripheral devices

Parts name	Parts No.	Remarks
Printer EP-60A	321-42008-10	
Printer EP-80	321-62675-01	
RS-232C interface IFB-102A	321-41167-10	
Calibration weigh (OIML F1 class in the box)	200g 321-53446	For BL220H (L), 320H (L)
	500g 321-53447	For BL320S (L) For BL620S (L)
	2kg 321-53449	For BL2200H (L), 3200H (L) For BL3200S (L)

Maintenance parts

Parts name	Parts No.	Remarks
Pan (small): For 320S (L), 220H (L), 320H (L)	321-54847	
Pan (Large): For 620S (L), 3200S (L), 2200H (L), 3200H (L)	321-54846	
Pan supporter (small): For 320S (L), 220H (L), 320H (L)	321-53908-11	
Pan supporter (Large): For 620S (L), 2200H (L)	321-53908-01	
Pan supporter (Large): For 3200S (L), 3200H (L)	321-53908-02	
Guard	321-53901	
Guard cover	321-55654	
Protection cover	321-53902	
Level screw	321-53530	
AC adapter		option

16. PERIPHERAL DEVICES

16.1 The EP-60A Electronic Printer

Connection

When connecting this balance to the EP-60A, first be sure to pull up the AC adapter for the balance and EP-60A. Then connect to data I/O connector as shown below.

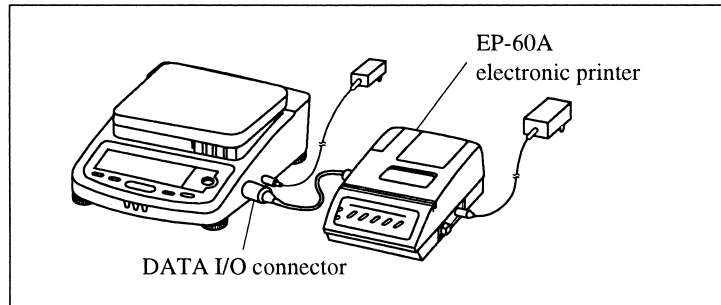

Functions

Manual printing

Autoprint

The displayed value is printed whenever the **PRINT** key is pressed.

In the g display of the balance, when the display is within zero \pm 3 count, the display is stabilized when the sample over 20 counts of g display is loaded, the balance automatically prints out. Unload this sample and wait for the display falls into within zero \pm 3 counts, then load a next sample.

Statistic

calculation

Pressing the **STAT** key statistically calculates and prints the data until next pressing of the **STAT** key.

See Instruction Manual for Electronic Printer EP-60A for further details.

16.2 The IFB-102A RS-232C Interface

The IFB-102A is used when the balance is connected to a personal computer.

Connection

When connecting the IFB-102A to the balance, be sure to pull up the AC adapter for the balance. Then insert the plug of IFB-102A into the DATA I/O connector of the balance.

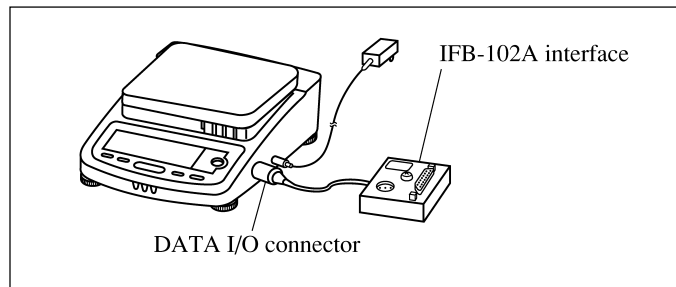

Signal

Pin No.	Signal	I/O	Function
1	FG		Ground
2	TXD	Output	Data output
3	RXD	Input	Data Input
4	RTS		
5	CTS		
6	DSR	Input	Transmitting is possible with (+) polarity.
7	SG		Ground
20	DTR	Output	Receiving is possible with (+) polarity

Example of connection

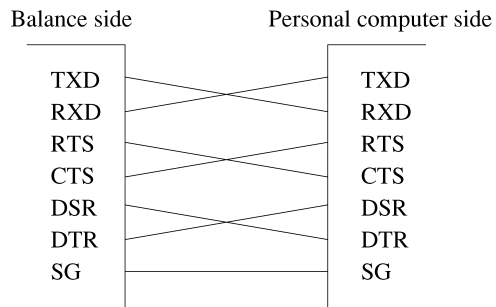

The above connection is one of examples. This may be different slightly depending on the personal computer connected to be balance.

Example of programming

The following example deals with such a program that the display value of balance is being displayed on the personal compute screen whenever the (SPACE) key of personal computer is pressed.

Baud rate: 1200 bps

Parity: none

Delimiter: CR

(" " means space.)

• **IBM/PCAT**

```

10  OPEN  "COM1, 1200, N, 8, 1"  AS  #1
20  Z$=INKEY$
30  IF  Z$=" "  THEN  20
40  PRINT  #1, " D05"
50  INPUT  #1, A$
60  PRINT  A$
70  GOTO  20
  
```

• **NEC PC-98**

```

10  OPEN  "COM : N81NN"  AS  #1
(20 line and under the same IBM/PC/AT)
  
```

Setting baud rate (1200BPS) by personal computer's memory switch.

16.3 Input/output Format

␣ means space and DL means delimiter.

Input data

Command code + DL

Refer to “16.5 Command Code”.

Output data

- For mass display

S- ␣ 1000.00g ␣ DL

Unit

At 1-byte: Unit + ␣

At 2-byte: Unit

At 3-byte: Unit

Polarity

At plus: Space (␣)

At minus: -

Stability information (only at output with stability information)

At stable: S

At unstable: U

- For σL , $-\sigma L$ display

U- ␣ ␣ ␣ ␣ σL ␣ ␣ ␣ ␣ DL

Polarity

At plus: Space ()

At minus: Minus (-)

Stability information (only at output with stability information)

At stable: S

At unstable: U

Data format

- ASCII (JIS) code
- Baud rate, parity, and delimiter change depending on menu selection.

16.4 Command Code

Described in this section are the command codes which can be used when your BL balance is connected to a computer via the IFB-102A RS-232C interface.

 **Caution**

The use of characters other than those described here will cause errors in weighing and data transfer procedures. If an improper code is mistakenly entered, disconnect the balance power cable for 10 seconds, then reconnect.

Command code	Function	Description
T	Taring	Equivalent to the TARE key
D05	Print (output once)	Equivalent to the PRINT key
D06	Autoprint	Refer to “16.1 The EP-60A Electronic Printer”.
D01	Continuous output	Continuous output of data in the balance at every approx. 100 ms. For less than 1200 bps, it becomes approx. 150 ms.
D09	Output stop	Autoprint or continuous output is canceled.
D07	Single output with stability information	Printing is made once with stability information.
D03	Continuous output with stability information	Continuous printing is made with stability information.
Q	ON/OFF selection	Toggles between standby state and measurement state.
{. }	Echo back	Characters from these command codes until delimiter are received and transmitted by every character. By use this command, message of personal computer is able to print out EP-60A. Characters length is under 16 characters, including delimiter.

17. Detailed information on Unit Conversion

Order in menu	Display			Unit	Conversion coefficient (1g=)	Minimum display in the unit (models with minimum display of 0.01g)
	Center section (segmented character display)	Unit display section	Illuminated triangular symbols in the right end row of the display; numbered from 1 to 4 from the top.			
1	Unit	g	none	g	1	0.01
2	Unit	kg	none	kg	0.001	0.00001
3	Unit	ct	none	carat	5	0.05
4	Unit	pcs	none	piece counting	_____	_____
5	Unit	%	none	percentage	_____	_____
6	Unit	oz	none	Oz(ounce)	0.035274	0.0005
7	Unit	ozt	none	Ozt(troy ounce)	0.0321507	0.0005
8	Unit	dwt	none	dwt(pennyweight)	0.643015	0.01
9	Unit	GN	none	GN(Grain)	15.4324	0.2
10	Unit H	tl	1	Hong Kong tael	0.0267173	0.0005
11	Unit S	tl	2	Singapore tael	0.0264554	0.0005
12	Unit t	tl	1,2	Taiwan tael	0.266667	0.0005
13	Unit	tl	4	Malaysia tael	0.0264600	0.0005
14	Unit	mom	none	momme	0.266667	0.005
15	Unit	lb	none	Lb(pound)	0.00220462	0.00005
16	Unit t1	tl	3,4	Taiwan tael	0.0266667	0.0001
17	Unit t2	tl	1,2,3	Taiwan tael	0.0266667	0.0002
18	Unit t3	tl	2,3,4	Taiwan tael	0.0266667	0.001
19	Unit 1	none	1	Sawaran	0.1250156	0.001
20	Unit 2	none	2	Kyats	0.0602409	0.001
21	Unit 3	none	3	Custom	0.0857338	0.001

*Remark

No.16~21 : It can be selected in special Area only.

 **SHIMADZU CORPORATION****TOKYO OFFICE**

3, Kanda-Nishikicho 1-chome, Chiyoda-ku, Tokyo 101-8448, Japan
Phone: 81(3)3219-5641 Fax: 81(3)3219-5710
Cable Add.:SHIMADZU TOKYO
Overseas Telex No.: 0232-3291 (SHMDT J)

KYOTO OFFICE

1, Nishinokyo-Kuwabaracho, Nakagyo-ku, 604-8511 Japan
Phone: 81(75)823-1200 Fax: 81(75)812-3438
Cable Add.:SHIMADZU KYOTO
Overseas Telex No.: 05422-166 (SHMDS J)

SHIMADZU INTERNATIONAL TRADING (SHANGHAI) CO., LTD.

(Shanghai Office)
Flat 24F Shanghai Xin Hua Lian Building, NO. 755, Huai Hai Zhong
Road Shanghai 200020, People's Republic of China
Phone: 86(21)6472-8442 Fax: 86(21)6472-8648

SHIMADZU SCIENTIFIC INSTRUMENTS INC

7102, Riverwood Drive, Columbia, Maryland 21046, USA
Phone: 1(410)381-1227 Fax: 1(410)381-1222

SHIMADZU EUROPA GmbH

Albert-Halm-Strasse 6-10, D-47269 Duisburg, F. R. Germany
Phone: 49(203)7687-0 Fax: 49(203)7666-25

SHIMADZU (ASIA PACIFIC) PTE LTD.

16 Science Park Drive #01-01 The Pasteur Singapore Science Park,
Singapore 118227, Republic of Singapore
Phone: 65-778-6280 Fax: 65-779-2935

SHIMADZU DO BRASIL COMERCIO LTDA.

Avenida Marques de Sao Vicente, 1771-Barra Funda,
CEP 01139-003, Sao Paulo, SP, Brazil
Phone: 55(11)861-1688 Fax: 55(11)861-2209

OPERATION Of BL series 1/2

★MENU SELECTION

STEP

- (1) Press the **CAL/MENU** key during the weight display.
- (2) “CAL” will be displayed.
- (3) Every time the **CAL/MENU** key is subsequently pressed, the display be changed in the order shown below.
- (4) Select the desired condition and press the **TARE** key. Then, it will be set or enter into the lower hierarchy.

Weight display	0.000
<Sensitivity calibration mode>	CAL
<Currently set condition>	St bSt
<Standard mode>	Stnd
<Sample pouring mode>	SAMPLE
<High stability mode>	Hi - Stb
<Advanced measurement, unit registration, unit registration, and individual setting mode>	Func.SEL
<Setting the value of sensitivity calibration weight>	CAL SEL
<Input/output format setting mode>	INTFACE
Weight display	0.000

- If the measurement is done at severe measurement environment and the stability of the display is not so good, set the balance to “Hi - Stb” (high-stability mode).
- When the high-speed sample pouring mode is executed, or the small amount of sample pouring is done, set the balance to “SAMPLE” (sample mode).

★SENSITIVITY CALIBRATION

STEP

- (1) Warm up the balance well. Refer to “INSTRUCTION MANUAL”.
- (2) Check leveling.
- (3) Unload the sample on the pan and press the **TARE** key to zero the display.
- (4) Following the menu selection, press the **CAL/MENU** key to display “CAL”.
- (5) Press the **TARE** key to start the sensitivity calibration.
- (6) The set weight value appears and blinks.
- (7) Make sure that the stability mark is lit.
- (8) Place the calibration weight on the pan. At this time, the stability mark will once disappear.
- (9) When the stability mark is lit again, press the **TARE** key.
- (10) The display shows zero and blinks. Make sure that the stability mark is lit.
- (11) Unload the weight.
- (12) When the stability mark is lit again, press the **TARE** key.
- (13) “CAL End” is displayed for several seconds and the balance returns to weight display. This completes the sensitivity calibration.
- (14) If the different weight is used for this sensitivity calibration, “CALE4” is displayed for several seconds and the balance returns to weight display. Check the weight and retry the sensitivity calibration.

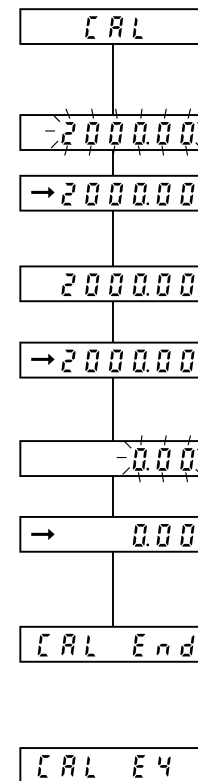

OPERATION Of BL series 2/2

★PCS SETTING

STEP

- (1) Register the PCS unit following the unit registration.
(Refer to the following.)
When PCS unit has been already registered, it is not necessary to register again.
- (2) Place the tare on the pan and press the **TARE** key.
- (3) Load the standard sample with required pieces.
- (4) Check that the stability mark is lit.
- (5) When pressing the **UNIT** key continuously, the display will change as follows:

“SEt 10^{PCS}”, “SEt 20^{PCS}”,
“SEt 50^{PCS}”, and “SEt 100^{PCS}”

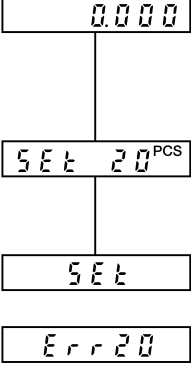
- (6) Select the desired PCS display and press the **TARE** key.
- (7) “SEt” is displayed for several seconds and the balance enters the PCS unit display. When the reference sample weight is less than “readability x No. of set pieces”, the PCS setting is not made.
In this case, “Err 20” is displayed for several seconds and the balance returns to weight display.

★% SETTING

STEP

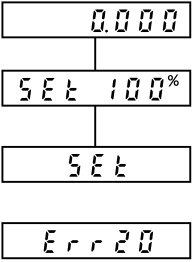
- (1) Register the % unit. (Refer to the following.)
When % unit has been already registered, it is not necessary to register again.
 - (2) Place the tare on the pan and press the **TARE** key.
 - (3) Load the reference sample.
 - (4) Continuously press the **UNIT** key to display “SEt 100%”.
 - (5) After the stability mark is lit, press the **TARE** key.
 - (6) “SEt” is displayed for several seconds and the balance enters the % unit display.
Minimum displayed value changes as follows depending on reference sample weight (REF.)
Reference sample weight (REF.) is count value which minimum displayed value rearranges one count.
If the % conversion is not possible, “Err 20” is displayed for several seconds and the balance returns to weight display.
- 

★REGISTRATION, CANCEL, AND CHANGE OF UNIT

Step for registration

- (1) Press the **CAL/MENU** key and select the *Funct. SEt* display.
(Press the **TARE** key.)
- (2) Press the **CAL/MENU** key and select the *Unit. SEt* display.
(Press the **TARE** key.)
- (3) The registrable unit is displayed by every pressing the **CAL/MENU** key.
The registrable units are three kinds which are selected from the following 14 kinds.
g, kg, ct, pcs, %, oz, ozt, dwt, GN, Hong-kong tail, Singapore tail, Taiwan tail, Maraysia tail, and Japanese “monme”
However, % and pcs (No. of pieces) cannot be registered simultaneously.
The stability mark is lit on the unit display currently registered.
- (4) Press the **TARE** key on the unit display to be registered. That unit is registered. When three kinds of unit are already registered, a new registration

deletes the oldest registration among the three registered units. However, % and pcs (No. of pieces) cannot be registered simultaneously. Then deletes unnecessary one.

- (5) Continuously pressing the **TARE** key returns the display to weight display.

Step for cancel

- (1) Carry out the same operation described (1) to (3) above to set unit display. Selecting the same one of the unit display which is currently registered (stability mark is lit) cancels the registration.

Step for change

- (1) Pressing the **UNIT** key changes the unit which is already registered.
However, even if the unit of % and pcs is already registered, the display does not change to this unit unless making a setting of reference value.