

Electronic Balance Instruction Manual

TW series

TW223L • TW323L • TW423L
TWC323L • TWC623L

TX series

TX223L • TX323L • TX423L
TX2202L • TX3202L • TX4202L
TXC323L • TXC623L

TXB series

TXB222L • TXB422L • TXB622L • TXB621L
TXB2201L • TXB4201L • TXB6201L • TXB6200L

Read the instruction manual thoroughly before you use the product. Keep this instruction manual for future reference.

 **SHIMADZU CORPORATION**
KYOTO JAPAN

ANALYTICAL & MEASURING INSTRUMENTS DIVISION

Name and Function of Components
Installation

Weighing
Outputting Weight Readings
Selecting the Display
Ending Weighing

Menu Settings
Calibration
Functions Relating to Taring
Adjusting Response and Stability
Setting Units
Application Function Mode
Comparator Function
Connection and Communication
with Peripheral Devices

Maintaining the Balance
Inspection
About Weights

What to Do If...
Responding to Messages...

Turning the Power ON and OFF
Backlight ON / OFF (TXB Only)
Changing the Password
GLP Output Function
Specifications
Maintenance Parts
List of Functions That Can Be Used
in Combination
Menu Map

BEFORE
WEIGHING

USING THE
BALANCE

USING MORE CONVENIENTLY

MAINTENANCE

TROUBLESHOOTING

FOR YOUR
INFORMATION

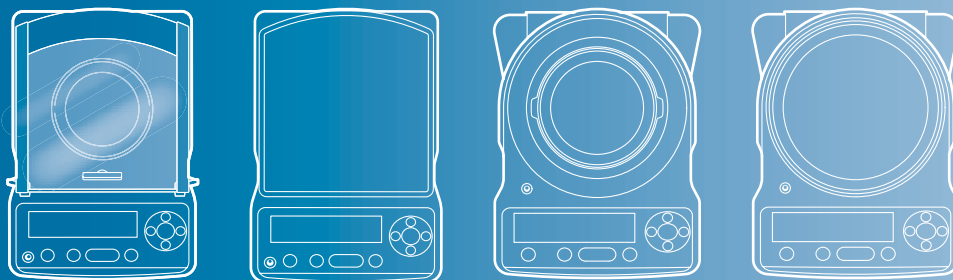

Requests

- Provide this manual to the next user in the event that the instrument is transferred.
- To ensure safe operation, contact your Shimadzu Balance representative for installation, adjustment, or reinstallation after moving the instrument to a different site.



Notices

- The content of this manual is subject, without notice, to modifications for the sake of improvement.
- Every effort has been made to ensure that the content of this manual was correct at the time of creation. However, in the event that any mistakes or omissions are discovered, it may not be possible to correct them immediately.
- The copyright of this manual is owned by Shimadzu Corporation. Reproduction and duplication of whole or part of the content without permission of the company are strictly prohibited.
© 2007-2009 Shimadzu Corporation. All rights reserved.
- "Microsoft", "Windows", "Windows Vista" and "Excel" are registered trademarks of Microsoft Corporation of the U.S.A. in the United States and other countries. All other company names and product names that appear in this manual are trademarks or registered trademarks of the companies concerned. Note that TM and ® indications are not used.
- The company names, organization names and product names in this manual are trademarks or registered trademarks of the companies and organizations concerned.
- Shimadzu does not guarantee that the WindowsDirect communication function will operate without problems on all PCs. Shimadzu will accept no responsibility for any trouble that arises as a result of using this function. You are recommended to back up all important data and programs in advance.

Introduction

Thank you for purchasing a Shimadzu TW/TX/TXB series electronic balance.

The TW/TX/TXB series models are high performance electronic balances that we confidently recommend based on over 80 years of precision balance manufacture. While these models are of course capable of fast and accurate weighing, the TW/TX models all use the Unibloc cells that Shimadzu started using for electronic balances in 1989, and the TXB models use our unique, newly developed and robust load cells, improving the reliability of the balances still further.

The new TW/TX/TXB series balances also feature operation keys for four directions, improving operating convenience and making the balances easier to use.

These balances also feature a variety of other functions that make it more convenient for customers to use them for their own applications, including the WindowsDirect communication function, which enables measuring results to be transferred to a PC without installing any software.

To ensure that you can make full use of the performance and functions of your TW/TX/TXB series balance, read this instruction manual carefully and use the balance correctly in accordance with the directions in the manual. When you have finished reading the manual, keep it in a safe place together with the balance so that you can refer to it at any time.

For information on the following points, please contact your Shimadzu Balance representative.

- Product warranty
- After service

How to Find the Information You Need

This manual allows you to search for a function or operating procedure in a number of ways.

- "Cover index" Search for the information by thumbing through the manual.
- "What You Can Do", page 6 Search for what you want to do.
- "Menu Map", page 150 Search quickly for the menu option you want to use.
- "Table of Contents", page 14 Search for information based on its order of appearance in the manual.
- "Index", page 154 Search for information based on a key word.

◆ Conventions used in menu operations

The instruction manual describes menu operations in a simplified form.

Example:

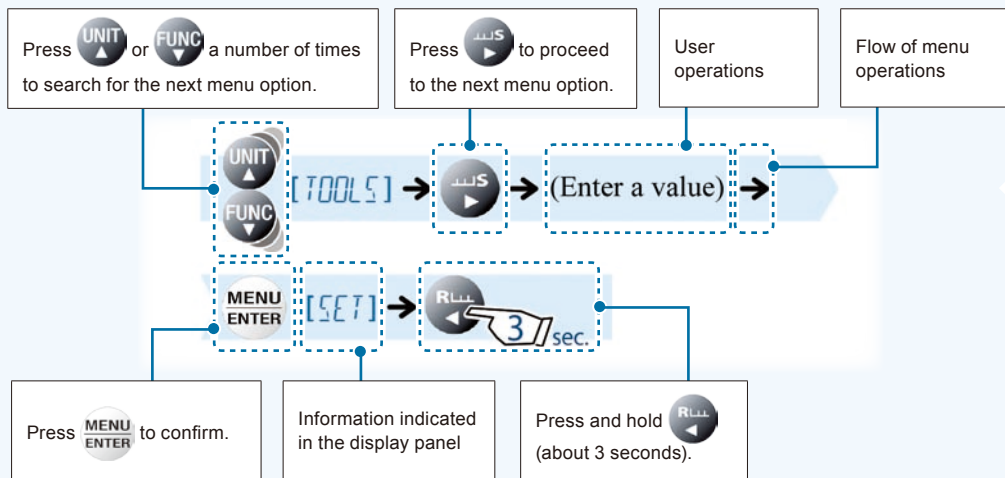

◆ Conventions used for the display panel

This instruction manual depicts the display panel in relation to particular operating procedures. The actions of the display panel (flashing, lighting up, confirmation) are shown in the following way.

• Flashing



• Lit



• Confirmation



◆ Example page

Linked to the cover index (right-hand pages only)

Index

Notes
Information to help use the balance correctly

Reference

Menu operation

Explanation of terms

Depiction of the display

WindowsDirect Communication Function

In any Windows application (e.g. Excel or the weight input window of an analytical device), the data entered from the keyboard is transferred to the cursor position just as if it had been entered from the keyboard.

What to do if...

- ◆ On installing communications software in the PC and attempting communications, it is not possible to use the WindowsDirect communication function even though the OS is Windows.
- ◆ Perform communications setting as described in "User-Specified Settings" (page 109).
- ◆ When transferring the balance from a PC, you must use command codes for programming (page 103).

Setting the Function

- ◆ Making the settings at the balance

- 1** Press **[F10]** for about 3 seconds in the weighing mode.
This opens the output menu.
- 2** Select WindowsDirect communication.
[WIN] → **[WIN]** (Select the output data format.)

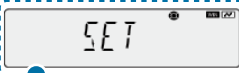
When "WIN" has been selected:
- 3** Confirm and return to the weighing mode.
[ENTR] **[SET]** → **[ENTR]**

This completes the setting procedure at the balance.

What is the WindowsDirect communication function?
The numerical value displayed at the balance can be transferred to the cursor position just as if it had been entered from the keyboard.

Continued on next page

95

Continued on next page

The symbol shown in the figure below appears at the head of the next page.

The title of the previous page appears here.



What You Can Do

This section lets you search for a method you would like to try or a function you want to know about.

Various weighing methods

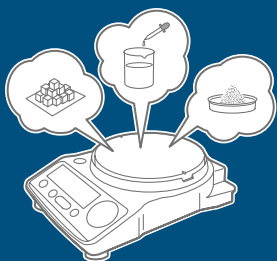

- I want to weigh up to a fixed quantity by adding increments of the same sample (item to be weighed: powder, liquid, etc.) a little at a time.

Pouring Mode ➔ page 77

- I want to make fine adjustments during weighing, like increasing the reaction speed of the display or stabilizing the display.

Easy Setting ➔ page 78

- I want to use the balance to count items.
- I want to set unit weights (the weight of a single piece of the item being weighed) for multiple samples in advance.

Piece Counting ➔ page 87

- I want to weigh in percentages.

Percentage Weighing ➔ page 92

- I want to weigh a fixed amount of each of a number of different samples (items to be weighed: powder, liquid, etc.) and to mix these samples according to a formula.

Formulation ➔ page 96

- I want to check excess or deficiency with respect to a target value and make "pass or fail" judgments accordingly.

Comparator Function ➔ page 102

- I want to adjust the conditions under which the stability mark lights up.

Adjusting the Stability Mark ➔ page 79

Zero point, and taring

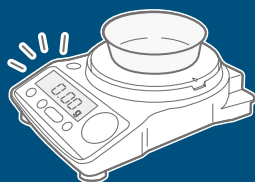

- I want to stabilize the display at zero when an empty sample container is placed on the pan.

Zero Tracking Function ➔ page 71

- I want to automatically return the display to zero after weighing.

Auto Zero Function ➔ page 72

- I want to automatically tare the balance (set the display to zero) after outputting a weight reading.

Auto Tare Function ➔ page 74

- I want to tare the balance without waiting for the stability mark to light up.

Zero / Tare Timing Change Function ➔ page 75

Calibration

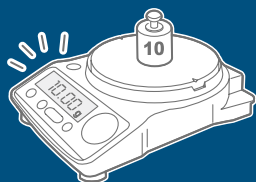

- I want to adjust the balance so that it is very accurate after stabilization.
Span Calibration and Adjustment ➔ page 56
- I want to carry out calibration and output a record.
Leaving a Record of Calibration ➔ page 67
- I want to check the degree of drift in the balance's sensitivity.
Calibration Check ➔ page 60

Printing / output



- I want to send data to a PC (e.g. to Excel).
WindowsDirect Communication Function ➔ page 111
- After weighing, I want to output automatically upon stabilization.
Auto Print Function ➔ page 106
- I want to output data continuously.
Continuous Output Function ➔ page 108
- I want to output data either immediately or after stabilization.
Output Timing Change Function ➔ page 129
- I want to change the format of the decimal point (comma or period) in the output data.
Selecting the Decimal Point Display Symbol ➔ page 42
- I want to add the balance model name, ID and other information to weight readings.
GLP Output Function ➔ page 142

Miscellaneous

- I want to display weights in units other than g (grams).
Switching Units ➔ page 41
Setting the Units ➔ page 82
- I want the power to turn off automatically when I am not using the balance.
Auto Power-Off Function ➔ page 138
- I want to go directly into weighing mode when the power is switched ON.
Setting the Startup Display ➔ page 139

Safety Precautions

To be strictly observed

To ensure that you use the balance safely and correctly, read the following precautions carefully and observe them.

The levels of danger and damage that will arise if the balance is used incorrectly are classified and indicated as shown below.



CAUTION

Indicates a potentially hazardous situation which, if not avoided, may result in minor to moderate injury or equipment damage.

Precautions are classified and explained by using one of the symbols below, depending on the nature of the precaution.



Instructions

Indicates an action that must be performed.



Prohibitions

Indicates an action that must NOT be performed

CAUTION



Prohibitions

Never disassemble, modify or attempt to repair this product or any accessory.

You could sustain an electric shock or the product could operate abnormally.
If you believe that the balance has failed, contact your Shimadzu representative.

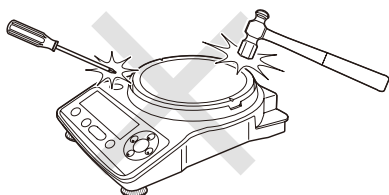

Prohibitions

Do not use the balance outdoors or anywhere where it will be exposed to water.

You could sustain an electric shock or the product could operate abnormally.

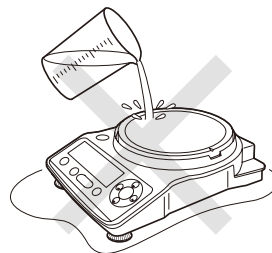

Instructions

Use the balance with the specified power supply and voltage.

Using the balance with an incorrect power supply or voltage will lead to fire or trouble with the balance.
Note also that if the power supply or voltage is unstable or if the power supply capacity is insufficient, it will not be possible to obtain satisfactory performance from the balance.



Instructions

If you detect anything abnormal (e.g. a burning smell) disconnect the AC adapter immediately.

Continuing to use the balance with an abnormality could lead to fire or an electric shock.



Prohibitions

Do not connect anything other than peripheral devices specified by Shimadzu to the balance's connector.

If you do, the balance may stop working normally.
In order to avoid trouble, always connect peripheral devices in accordance with the directions in this manual.



Prohibitions

Do not use the balance anywhere exposed to explosive, combustible or corrosive gases.

This could cause fire or trouble.

Precautions on Use



Prohibitions

Avoid locations where the balance will be exposed to any of the following.

You may not be able to obtain correct weight readings.

- Air flow from an air conditioner, ventilator, door or window
- Extreme temperature changes
- Vibration
- Direct sunlight
- Dust, electromagnetic waves or a magnetic field

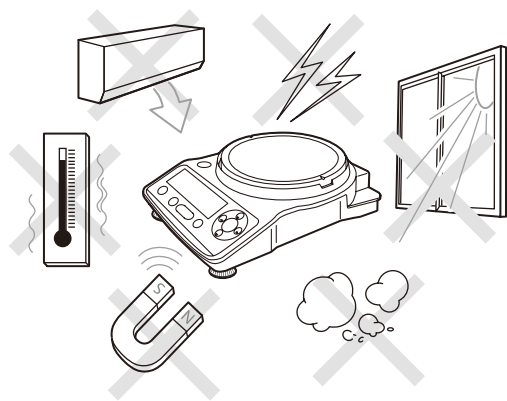

Instructions

Install the balance on a strong and stable flat table or floor.

Placing the balance in an unstable site could lead to injury or trouble with the balance.

When selecting the installation site, take into account the combined weight of the balance and the item to be weighed.

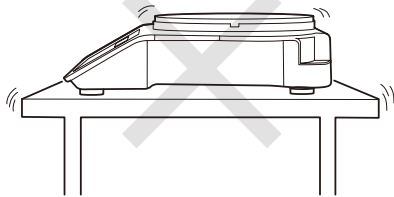

Instructions

Treat the balance with care and respect.

The balance is a precision instrument. Subjecting it to impacts could cause it to fail.

When moving the balance, remove pan and pan supporter. Grasp it firmly with both hands to carry it.

If the balance has to be stored for a long time, store it in the packaging box in which it was delivered.

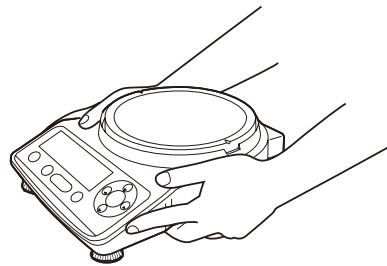

Instructions

After a power outage, turn the power back ON.

When a power outage occurs, the power is shut off automatically. Therefore, begin operation from "Turning the Power ON" (🔌 page 31) again.



Instructions

Use the correct weighing units.

Using incorrect weighing units can lead to accidents as a result of weighing errors.

Check that the weighing units are correct before starting weighing.

This Declaration of Conformity is valid only for models that bear the CE mark on the main body of the balance.

Declaration of Conformity

Manufacturer's Name: SHIMADZU CORPORATION
Analytical & Measuring Instruments Division
Address : 1, Nishinokyo-Kuwabara-cho, Nakagyo-ku,
Kyoto 604-8511, Japan

declares in sole responsibility that the following product

Product Name **Electronic Balance**
Model Name **TW , TX and TXB series**
P/N **Depend on configuration. See Appendix 1 and 2.**

referred to in this declaration conforms with following directives and standards

EMC Directive 2004/108/EC
EN 55022:2006 (Class B)
EN 55024:1998 + amendment A1:2001 + amendment A2:2003
EN 61000-3-2:2006
EN 61000-3-3:1995 + amendment A1:2001 + amendment A2:2005
Low Voltage Directive 2006/95/EC
EN 60950:2001

The last two digits of the year in which CE marking was affixed for Low Voltage Directive 2006/95/EC are 03.

- Note 1) This declaration becomes invalid if technical or operational modifications are introduced without manufacturer's consent.
Note 2) This declaration is valid if this product is used alone or in combination with the accessories of this product which are mentioned in attached Appendix 1 or other instruments which fulfill with the requirement of mentioned directive.
Note3) Importer/Distributor and Authorised Representative in EU is as follows:
SHIMADZU EUROPA GmbH
Address :Albert-Hahn-Strasse 6-10, 47269 Duisburg, F.R. Germany

Kyoto, JAPAN 28 July 2009
Place and date of issue

Koji Okada
Signature
Koji Okada
Name
General Manager of Quality Assurance Department
Analytical & Measuring Instruments Division
Title



Electromagnetic Compatibility

Descriptions in this section apply to all models:

TW , TX , TXB series

This product complies with European standard EN55022 : 2006 , class B for electromagnetic interference (Emissions) and minimum requirement for electromagnetic susceptibility (Immunity).

EN55022 Emissions (Electromagnetic Interference)

This is a class B product.

When this product causes an electromagnetic disturbance to devices being used near this product, create an appropriate distance between those devices and this product in order to eliminate the disturbance.

EN55024 Immunity (Electromagnetic Susceptibility)

Test conditions are as follows.

EN 61000-4-2	Electrostatic Discharge:	Air: 8 kV, Contact: 4 kV
EN 61000-4-3	Radiated, Radio-Frequency, Electromagnetic Field:	3 V/m
EN 61000-4-4	Transient/Burst (Electrical Fast Transients):	1 kV to AC power line and ground
EN 61000-4-5	Voltage Surge:	1 kV line to line, 2 kV line to ground
EN 61000-4-6	Conducted RF Immunity:	3 V
EN 61000-4-8	Power Frequency Magnetic Field Immunity:	1 A/m
EN 61000-4-11	Voltage Variations/Dips/Interrupts:	>95% drop

Compliance with these standards does not ensure that the product can operate at a level of electromagnetic interference that is stronger than the level tested. Interference stronger than the values specified above may cause the product to malfunction.

When installing or using this product, especially in an industrial location:

Locate the product away from any device emitting strong levels of electromagnetic noise.

Use a power source that is separated from the power source of any device emitting strong levels of electromagnetic noise.

To prevent static electricity:

Prior to touching the product, the operator should be sure to discharge the static electricity stored in their body by first touching a grounded metallic structure.

Do not touch any terminals or connectors that are not connected to cables while the product is turned ON.

Shimadzu Balances and 21 CFR Part 11

21 CFR Part 11

21 CFR Part 11, Electronic Records, Electronic Signatures, Final Rule (often referred to as Part 11) is the United States Food and Drug Administration (FDA) regulation affecting computer resources and electronic records that are used for any document that is required to be kept and maintained by FDA regulations.

Requirements concerning computer resources security are key elements in Part 11.

The controls implemented as a result of security related requirements are intended to result in trusted records.

Shimadzu CLASS-Balance Agent

Shimadzu provides a means for compliance with 21 CFR Part 11 with Shimadzu CLASS-Balance Agent software, part of a comprehensive laboratory data management system, Shimadzu CLASS Agent.

Ask your Shimadzu representative about it.

Shimadzu WindowsDirect

When Shimadzu balances are integrated with laboratory software by means of our WindowsDirect function, no communication software is required or used.

The Shimadzu balance functions as a primary device in the system, just as a keyboard, mouse or other data entry hardware does.

For this reason, system validation and compliance may be greatly simplified with the use of Shimadzu balances.

Two-way Communication

Shimadzu balances have always been computer friendly and they can be set up for bi-directional communication as part of a fully automated production system or LIMS.

This manual includes the command codes and information needed by programmers to integrate Shimadzu balances with their software.

Action for Environment (WEEE)

To all user of Shimadzu equipment in the European Union:

Equipment marked with this symbol indicates that it was sold on or after 13th August 2005, which means it should not be disposed of with general household waste. Note that our equipment is for industrial/professional use only.

Contact Shimadzu service representative when the equipment has reached the end of its life. They will advise you regarding the equipment take-back.

With your co-operation we are aiming to reduce contamination from waste electronic and electrical equipment and preserve natural resource through re-use and recycling.

Do not hesitate to ask Shimadzu service representative, if you require further information.

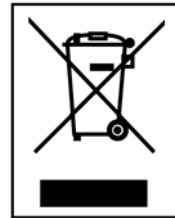

WEEE Mark

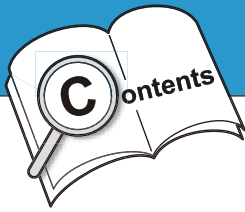

Table of Contents

1 BEFORE WEIGHING 20

Name and Function of Components	20
■ TW/TX Series	20
■ TXB Series	21
■ Operation Keys	22
■ Menu Operation Keys	22
■ Display Panel	23
Installation	24
■ Choosing the Installation Site	24
■ Unpacking and Delivery Inspection	26
■ Installing the Components	27
■ Adjusting the Level of the Balance	29
■ Turning the Power ON	31
■ Warming Up	33
■ Performing Span Calibration	34

2 USING THE BALANCE 38

Weighing	38
Outputting Weight Readings	40
Selecting the Display	41
■ Switching Units	41
■ Selecting the Minimum Number of Displayed Digit	41
■ Selecting the Decimal Point Display Symbol	42
Ending Weighing	43
■ Turning the Power OFF	43

3 MENU SETTINGS 46

What Is the Menu?	46
■ The Structure of the Menu	46
■ Menu Map	47
■ Instruction Manual	47
■ Menu Operation Key Symbol	47
Basic Menu Operations	48

Entering Numerical Values	49
■ Changing the Numerical Value	49
■ Changing the Position of the Decimal Point	50
Convenient Functions for Menu Setting	51
■ Returning to the Default Settings (Menu Reset)	51
■ Prohibiting Changes to the Menu Settings (Menu Lock)	52
■ Outputting the Menu Setting Information	53

4 CALIBRATION 54

Before Starting Calibration.....	54
Span Calibration and Adjustment	56
Calibration Check	60
Calibration of the Internal Weight (TW Only)	64
Leaving a Record of Calibration	67
■ Example Printout of a Calibration Record	67
■ Setting Output of a Calibration Record	68
■ Setting a Balance ID	69

5 FUNCTIONS RELATING TO TARING 70

Zero Tracking Function	71
Auto Zero Function	72
Auto Tare Function	74
Zero / Tare Timing Change Function	75

6 ADJUSTING RESPONSE AND STABILITY 76

Selecting the Weighing Mode	77
■ Selecting the General Weighing Mode	77
■ Selecting the Pouring Mode	77
Easy Setting of Response and Stability	78

Adjusting the Stability Mark	79
■ Setting the Stability Detection Range	79
■ Setting the Stability Mark Lighting Timing	80

7 SETTING UNITS 82

■ Units That Can Be Displayed and Conversion Factors	82
Selecting Units to Display	83
Setting User-Specified Units	84
■ Conversion Factors	84
■ Minimum Indication	85

8 APPLICATION FUNCTION MODE 86

Counting Pieces by Weight (Piece Counting)	87
■ Preparation for Piece Counting (Including Setting the Unit Weight)	87
■ Counting Numbers of Pieces	90
■ Changing a Unit Weight, or Adding a New Unit Weight.	91
Percentage Weighing	92
■ Preparation for Percentage Weighing	92
■ Weighing Percentages	95
Formulation	96
■ Performing Formulation	96
■ Outputting Component Numbers	99
■ Outputting the Gross Weight	100

9 COMPARATOR FUNCTION 102

Target Mode	102
Checkweighing Mode	104

10 CONNECTION AND COMMUNICATION WITH PERIPHERAL DEVICES 106

Convenient Functions Relating to Output	106
■ Printing / Outputting Automatically (Auto Print Function)	106
■ Printing / Outputting Continuously (Continuous Output Function)	108
WindowsDirect Communication Function	111
■ What Is the WindowsDirect Communication Function?	111
■ Setting the Function	111
■ Troubleshooting the WindowsDirect Communication Function	116
Connecting to a PC (RS-232C)	117
■ Cable Connection Method	117
■ Data Format	118
■ Command Codes	120
Connecting to a Printer	124
Communication Settings	125
■ Standard Settings (MODE)	126
■ User-Specified Settings	126
Output Timing Change Function	129

11 MAINTENANCE 130

Maintaining the Balance	130
■ Removing the Glass Door	131
Inspection	132
■ Daily Inspections	132
■ Periodic Inspections	133
About Weights	134
■ Types of Weight and Their Selection	134

12 TROUBLESHOOTING 136

What to Do If.....	136
Responding to Messages	137

13 FOR YOUR INFORMATION 138

Turning the Power ON and OFF	138
■ Auto Power-Off Function	138
■ Setting the Startup Display	139
Backlight ON/OFF (TXB Only)	140
Changing the Password	141
GLP Output Function	142
■ Setting the GLP Output Function	142
■ Setting a Balance ID	144
Specifications	145
■ TW/TX Series	145
■ TXB Series	146
Maintenance Parts	147
■ TW/TX Series	147
■ TXB Series	148
List of Functions That Can Be Used in Combination	149
Menu Map	150
■ Reading the Menu Map	150
■ Main Menu	151
■ Data Output Menu	152
■ Unit Setting Menu	153
■ Calibration Menu	153
■ Zero / Tare Menu	153

MEMO

BEFORE
WEIGHING

USING THE
BALANCE

USING MORE CONVENIENTLY

MAINTENANCE

TROUBLESHOOTING

FOR YOUR
INFORMATION

1

BEFORE WEIGHING

Name and Function of Components

TW/TX Series

The TW/TX Series comprises toploading electromagnetic balances with UniBloc weighing mechanism.

◆ Main body

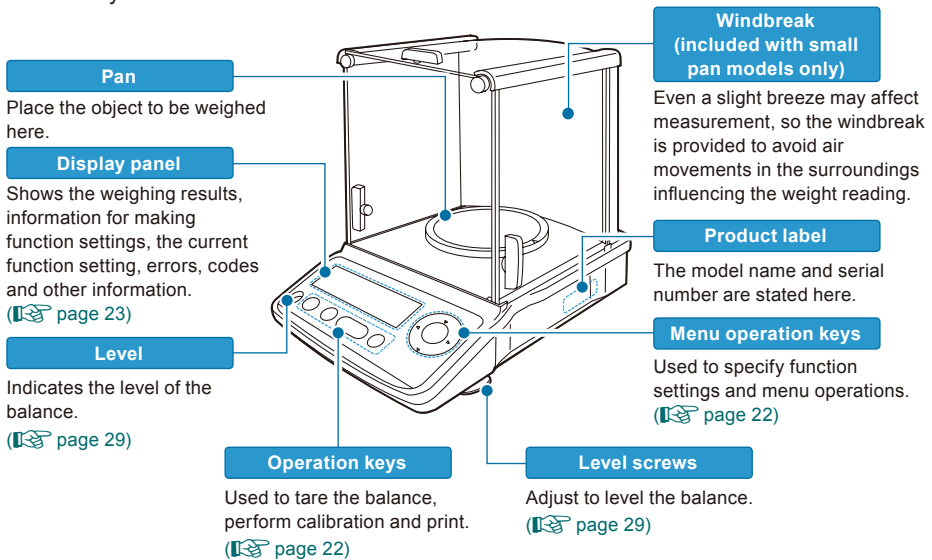

◆ Back of the unit

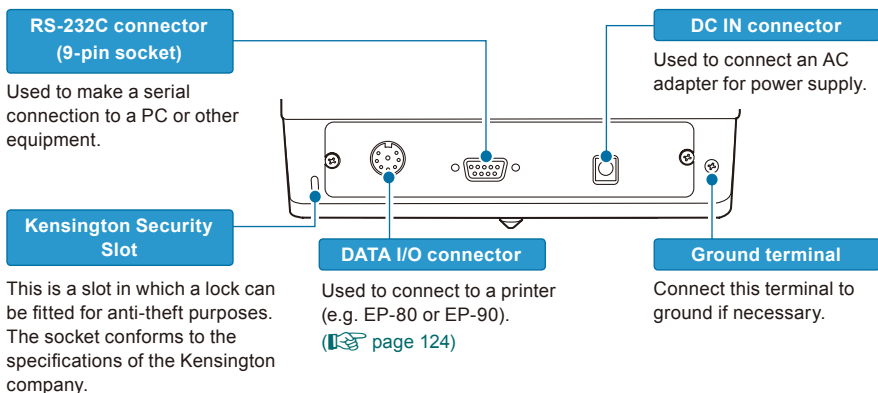

TXB Series

The TXB Series comprises load cell type toploading balances that can be powered by batteries as well as AC power.

◆ Main body

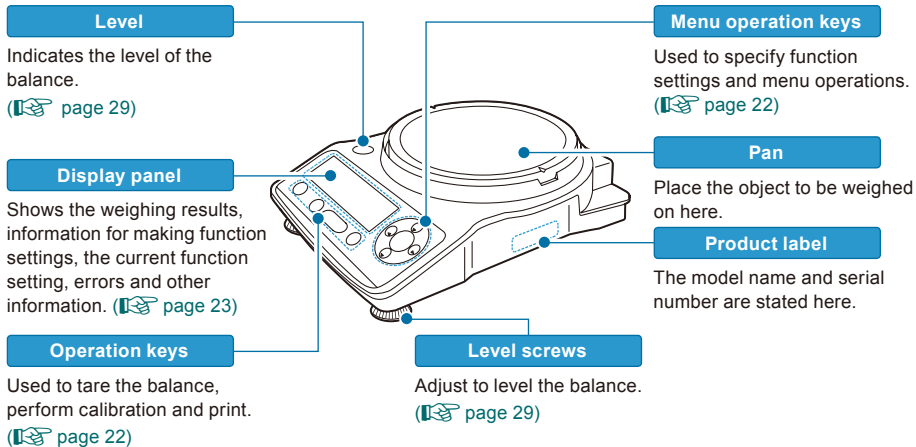

◆ Underside of the unit

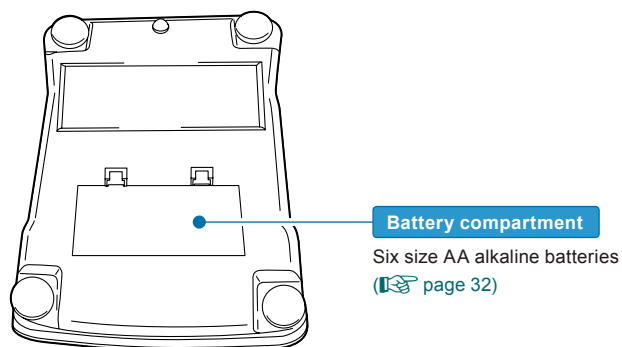

◆ Back of the unit

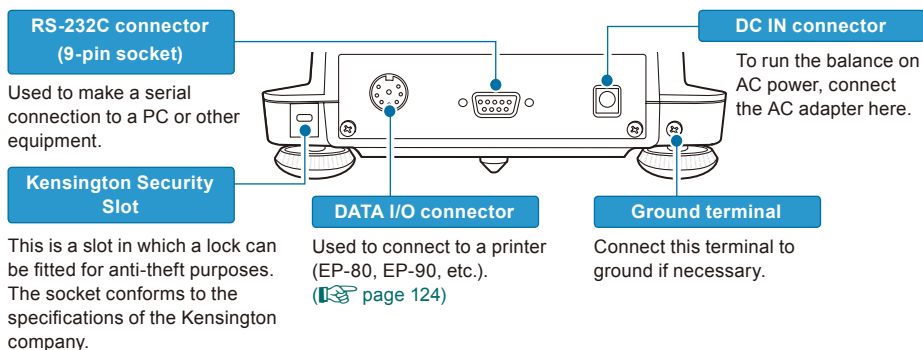

▽ Continued on next page

1 BEFORE WEIGHING

▽ Name and Function of Components

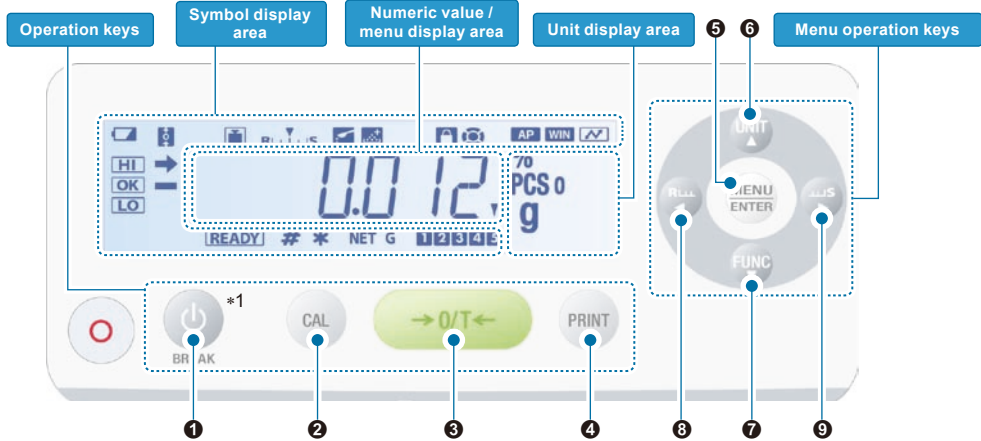

*1 With the TXB series,  is provided.

Operation Keys

No.	Key	During Weighing		During Menu Operation
		Press Once and Release ...	Press and Hold for About 3 Seconds ...	
1	[BREAK]	Switch between the operation and standby modes	-	Suspends calibration / numerical value entry.
2	[CAL]	Performs calibration	Enters the calibration menu	-
3	[O/T]	Tares the balance (setting it to zero)	Opens the zero / tare menu	-
4	[PRINT]	Outputs the weight reading to a peripheral device (printer or PC)	Opens the data output menu	-

Menu Operation Keys

No.	Key	During Weighing		During Menu Operation
		Press Once and Release ...	Press and Hold for About 3 Seconds ...	
5	[MENU/ENTER]	Displays the main menu	Shows the menu displayed last	Confirms and sets the displayed entry
6	[UNIT] ▲	<ul style="list-style-type: none"> In the weighing mode: Used to select the unit When piece counting: Displays the unit weight When performing percentage weighing: Displays the reference weight 	<ul style="list-style-type: none"> In the weighing mode: Opens the unit setting menu When piece counting: Used to select the item number When performing percentage weighing: Used to select the percentage reference 	<ul style="list-style-type: none"> Scrolls backward through menu options When entering numerical values: Increases the value
7	[FUNC] ▼	Switches between the weighing mode and the application function mode	Selects the minimum number of displayed digits	<ul style="list-style-type: none"> Scrolls forward through menu options When entering numerical values: Reduces the value
8	[Res] ◀	The response of the display is increased.	-	<ul style="list-style-type: none"> Takes you to a higher level in the menu hierarchy When entering numerical values: Moves the focus one digit to the left Suspends menu operation
9	[Stb] ▶	The stability of the display is increased.	-	<ul style="list-style-type: none"> Takes you to a lower level in the menu hierarchy When entering numerical values: Moves the focus one digit to the right

Display Panel

Display	Name	Description	See:
	Battery symbol	Lights up when the power supply voltage is low, for example when the battery voltage is low.	Page 33
	Zero tracking symbol	Lit when the zero tracking function is set ON.	Page 71
	Weight symbol	This symbol is lit during calibration.	Page 57 Page 62
	Easy setting indicator	Indicates what level the response and stability are currently set to.	Page 78
	Pouring symbol	Lit when the pouring mode is set.	Page 77
	Formulation symbol	Lit during mixing measurement (formulation) operations.	Page 96
	Menu lock symbol	Lit while the menu is locked.	Page 52
	Menu operation key symbol	During menu operation, indicates which of the menu operation keys can be used.	Page 47
	Auto print symbol	Lit when the auto print function is set.	Page 108
	Win symbol	Lit when the WindowsDirect communication function has been set.	Page 112
	Communication symbol	Indicates that data is being exchanged with an external device.	-
	Comparator symbol	When the comparator function (Checkweighing) has been set, indicates the comparison judgment.	Page 102
	Stability mark	Lit when the weight reading is stable. Lit when the option currently set in menu setting is displayed.	Page 48 Page 79
	Minus symbol	Lit when the weight reading is negative.	-
	Ready symbol	Lit during the standby mode (TW/TX Series only). During weighing, lit to indicate the ready to weigh status, for example when using the formulation function.	Page 43 Page 96
	Number symbol	Lit when it is possible to enter numerical values.	Page 49
	Hold symbol	Lit when a value that is not the real-time weight reading (for example the indication of the unit weight in piece counting) is displayed.	Page 90 Page 95
	Net weight symbol	Indicates that the weight reading displayed in mixing measurement (formulation) is the net weight of the current component with the weight of the container and prior components. Also indicates that a measuring operation is in progress.	Page 97
	Gross weight symbol	Indicates that the weight reading displayed in mixing measurement (formulation) is the total weight of all of the components of the mixture with the weight of the container subtracted.	Page 97
	Item number indication	Shows the item number in the piece counting mode.	Page 90
	Inverse triangle symbol	When this symbol is lit when changing the position of the decimal point in the conversion factor with the of user-specified units, numerical values can be entered without a decimal point.	Page 50
	Piece counting symbol	Lit while the piece counting mode is in effect.	Page 90
	Specific percentage weighing symbol	Lit when the specific percentage reference has been set for percentage weighing.	Page 94
	Percentage weighing symbol	Lit during percentage weighing.	Page 95

Installation

Choosing the Installation Site

The measuring performance of the balance is greatly influenced by the environment where it is installed.

Observe the following points to ensure safe and accurate weighing.

⚠ Caution



Prohibitions

Do not use the balance anywhere exposed to explosive, combustible or corrosive gases.

This could cause fire or trouble.

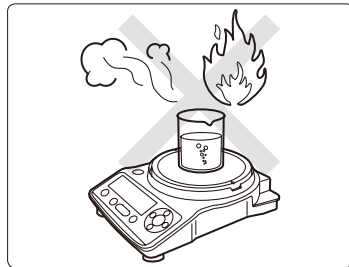

Instructions

Use the correct power supply and voltage with the balance.

Using an incorrect power supply or voltage with the balance will lead to fire or trouble with the balance.

Note also that if the power supply or voltage is unstable or if the power supply capacity is insufficient, it will not be possible to obtain satisfactory performance from the balance.

Precautions on Use



Prohibitions

Avoid locations where the balance will be exposed to any of the following.

- Air flow from an air conditioner, ventilator, door or window

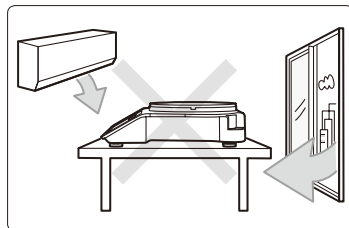

Precautions on Use



Prohibitions

Avoid locations where the balance will be exposed to any of the following.

- Extreme temperature changes

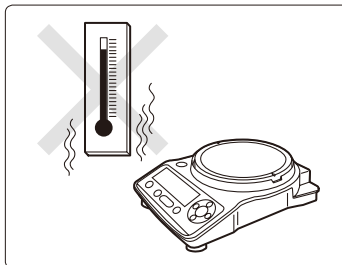

- Vibration from surroundings or nearby equipment

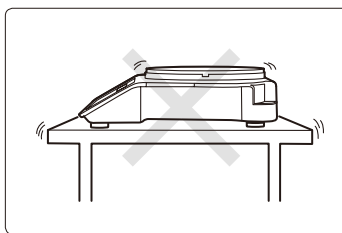

- Direct sunlight

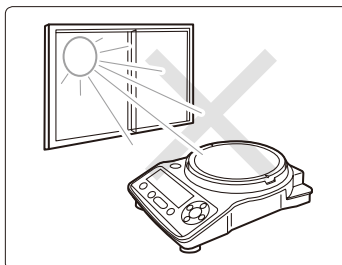

- Dust, electromagnetic waves or a magnetic field

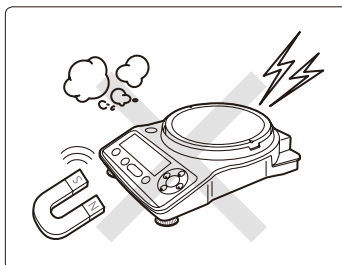

Instructions

Install the balance on a strong and stable flat table or floor.

Placing the balance in an unstable site could lead to injury or trouble with the balance. When selecting the installation site, take into account the combined weight of the balance and the item to be weighed.





Unpacking and Delivery Inspection

The items packed will differ depending on the model of balance ordered.



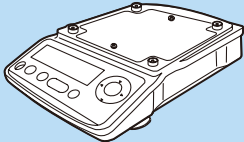
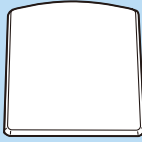

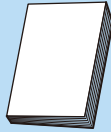
Check that all of the items indicated below are included in the package, and that nothing has been damaged.

The numbers in the boxes [] indicate the quantity of each item.

◆ TX Series (large pan model) TX***2L

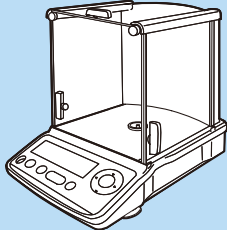
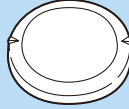
<input type="checkbox"/> Balance main body [1]	<input type="checkbox"/> Pan [1]	<input type="checkbox"/> Pan supporter cap [4]
		
<input checked="" type="checkbox"/> Instruction manual [1]	<input type="checkbox"/> Menu map sheet [1]	
		

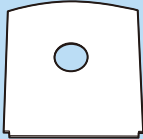
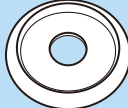
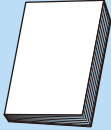
◆ TW/TX Series (small pan model) TW**3L, TX**3L TW/TX Series (carat model) TWC**3L, TXC**3L

<input type="checkbox"/> Balance main body (with windbreak) [1]	<input type="checkbox"/> Pan [1]	
		
<input type="checkbox"/> Pan supporter [1]	<input type="checkbox"/> Underplate [1]	<input type="checkbox"/> Pan ring [1] (TWC**3L, TXC**3L only)
		
<input checked="" type="checkbox"/> Instruction manual [1]	<input type="checkbox"/> Menu map sheet [1]	<input type="checkbox"/> Pan with grip [1] (TWC**3L, TXC**3L only)
		

◆ TXB Series (large pan model)
TXB***1L, TXB***0L

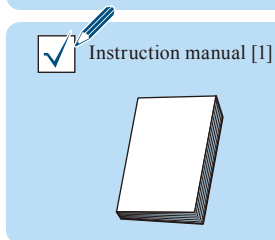
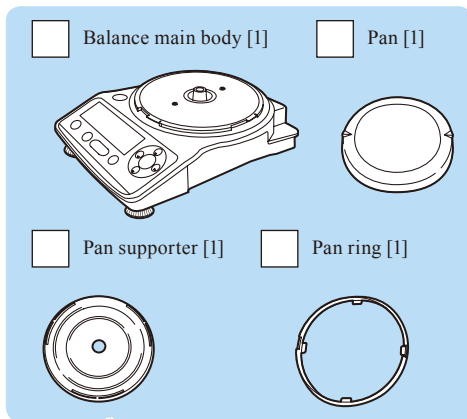

◆ TXB Series (small pan model)
TXB**2L, TXB**1L

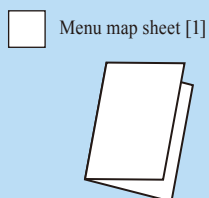
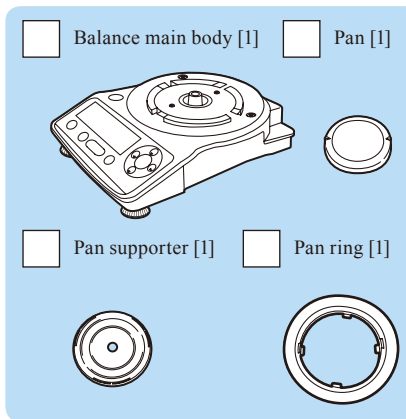

Installing the Components

The procedure for fitting the components differs depending on the model of the balance.

◆ TX Series (large pan model) TX***2L

1 Fit the four pan supporter caps.

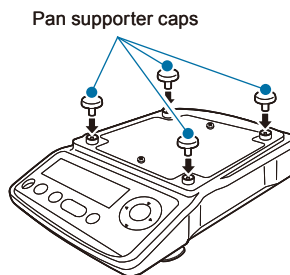

2 Place the pan on the pan supporters.

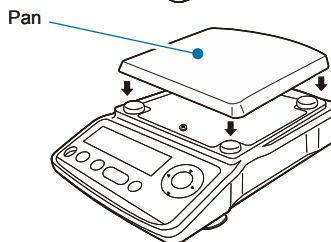

▽ Installation

- ◆ TW/TX Series (small pan model) TW**3L, TX**3L
TW/TX Series (carat model) TWC**3L, TXC**3L

1 Fit the underplate.

Open the glass door and insert the underplate slowly while tilting it. Be careful not to knock against the surroundings.

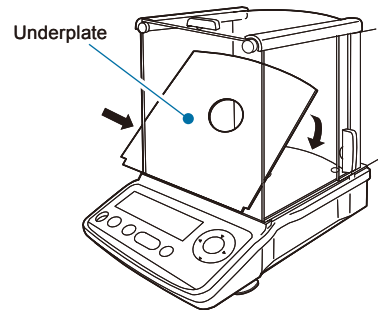

2 Fit the pan ring.

(TWC**3L, TXC**3L only)

3 Place the pan supporter.

4 Place the pan on the pan supporters.

Align the two pan notches with the left and right on the balance main body.

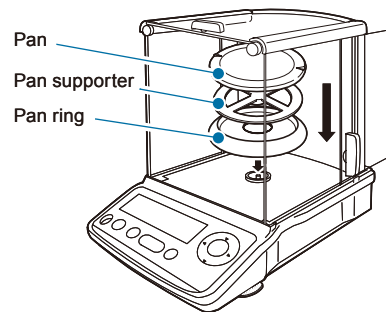

- ◆ TXB Series (common to large pan models and small pan models)

1 Fit the pan ring.

① Align the two pan ring notches with the left and right on the balance main body, and engage the four projections on the pan ring in notches in the balance main body.

Notches in the pan ring

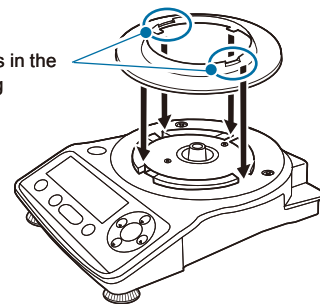

② Turn the pan ring counterclockwise until it clicks into place.

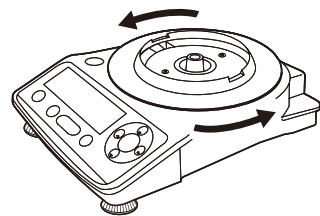

⚠ Caution



Instructions

Turn the pan ring until it clicks into place.

If the pan ring is not turned sufficiently, it will come into contact with the pan, and the display of the balance will become unstable.

2 Place the pan supporter.

3 Place the pan on the pan supporter.

Align the two pan notches with the left and right on the balance main body.

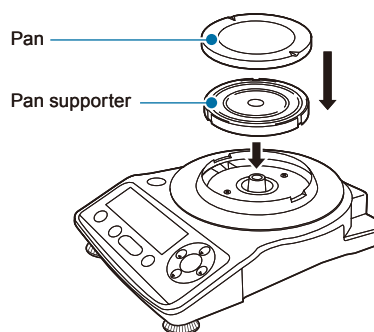

Adjusting the Level of the Balance

The level of this balance is maintained by three-point support involving a single fixed foot at center rear on the underside of the main body and two level screws on left and right at the front of the underside of the main body.

The large pan model also has level screws on left and right at the back, but they are used in an auxiliary role to prevent the balance from tilting when a heavy sample is placed on the pan.



Operation of the level screws

Turning the level screws clockwise, as viewed from above, extends them and raises the balance, while turning them counterclockwise retracts them and lowers the balance.

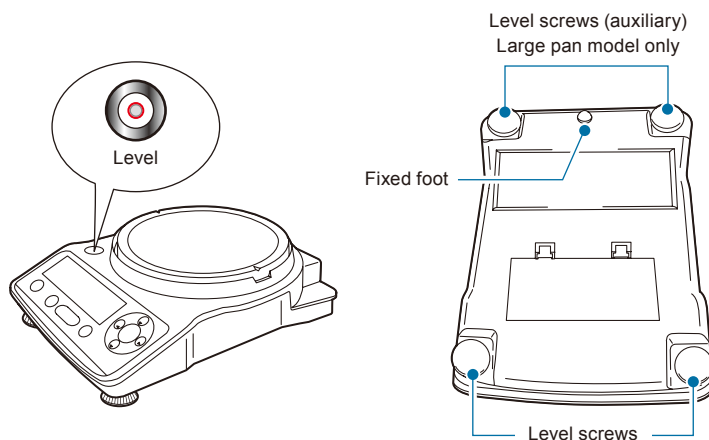

Level the balance by following the procedure below.

1 Turn all the level screws (total of four at front and rear) counterclockwise as viewed from above until they come to a gentle stop.





The balance will now be tilting toward the front, with the auxiliary level screws at the back of the large pan model lifted off the installation surface.

1 BEFORE WEIGHING

▽ Installation





2 Adjust the two level screws at the front so that the air bubble in the level becomes centered in the left/right direction.

At this stage it doesn't matter if the air bubble isn't centered in the front/rear direction.

If the air bubble is left of center 	➔	Turn the front right level screw clockwise. 
If the air bubble is right of center 	➔	Turn the front left level screw clockwise. 

3 Turn both the level screws at the front in the same direction at the same time to center the air bubble in the level in the front/back direction.

Adjust so as to bring the air bubble into the center of the circle.

On turning the two level screws at the front in the clockwise direction... 	➔	The bubble moves toward the front. 
On turning the two level screws at the front in the counterclockwise direction... 	➔	The bubble moves toward the back. 

With the large pan model...

4 Turn both of the auxiliary level screws at the rear clockwise to extend them to the point where they make light contact with the installation surface.

Note that if you overextend the auxiliary level screws at the rear the balance will become unstable.

Turning the Power ON

1 Insert the plug of the AC adapter into the DC IN connector on the back of the balance.

2 Connect the AC adapter to the power outlet (with the TXB series, press ).

The display will automatically go through the changes indicated below, ending with the OFF display.

The first information displayed is the software version number. Depending on the product, this may differ from the example shown below.

(This is the balance's self check display.)

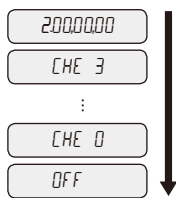

For the TW series...

An operation check on the internal weight mechanism is performed automatically. During this check, a small motor noise will be heard.



If "ERR H" is displayed...

See "Responding to Messages" ( page 137).

3 Press  ( with the TXB series).

All segments will light up momentarily, then the gram display will be shown.

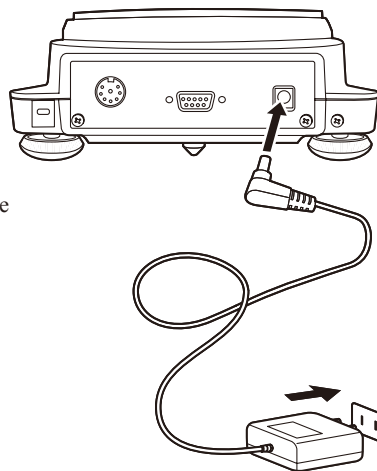

1 BEFORE WEIGHING

▽ Installation

◆ Using batteries (TXB Series only)

1 Remove the pan and pan supporter.

⚠ Caution



Prohibitions

Do not remove the pan ring.

Attempting to do so could break it. The pan ring protects the weighing mechanism when the balance is turned over.

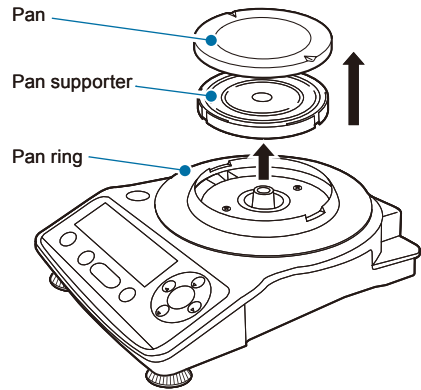

2 Turn the balance upside down.

3 Press the two catches on the battery compartment simultaneously in the direction indicated by the arrows.

The cover will come off.

⚠ Caution



Prohibitions

Do not open covers where a seal is affixed.

On no account open the covers inside the battery compartment that have seals affixed to them.

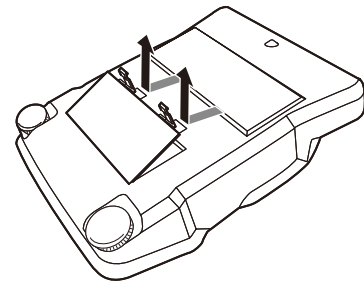

4 Insert the batteries and replace the cover.

Take care to insert the batteries with the correct polarity.

5 Press

The display will automatically go through the changes indicated below, ending with the OFF display.

(This is the balance's self check display.)

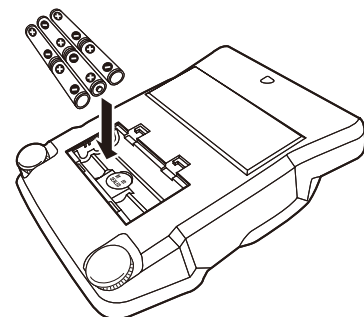

6

Press



The whole display will light up momentarily, then the gram display will be shown. If  (the battery symbol) lights up at this point, the probable cause is that the battery voltage is low.

Replace the batteries with new ones.



If you are not going to use the balance for a long time (a month or longer)...

In order to prevent damage by liquid leakage from the batteries, remove them from the battery compartment.

 "Turning the Power OFF", page 43

Warming Up

Before performing span calibration on the balance or measuring its accuracy, you must ensure that it is in a stable state.

When stabilizing the balance, it is important that its temperature is stable.

Put the balance in weighing mode (for example showing the gram display) and leave it with the power ON for at least an hour (two hours for the carat models TWC**3L and TXC**3L) in advance of calibration.

This is called "warming up".

With the TW/TX Series...

Warming up is also accomplished in the standby mode.

For details on the standby mode, see "Turning the Power OFF" ( page 43).

(* The standby mode is a function available with the TW/TX Series only. It is not featured on the TXB series.)

With the TXB Series...

When the auto power-off function operates, the power is shut off completely.

Before warming up for calibration, cancel the auto power-off function so that it cannot operate.

For details on the auto power-off function, see "Auto Power-Off Function" ( page 138).

■ Performing Span Calibration

Always perform span calibration for a balance after moving it. Weights are required for span calibration of the TX and TXB series. For details on weights, see "About Weights" (👉 page 134).

Before performing span calibration, warm up the balance in advance.

Also, carry out the adjustment at a location where there are few people moving around and there is no air flow or vibration.

◆ TW Series

1 Press

Calibration using the internal weight starts automatically.



If "WAIT" is displayed...

The calibration record is being output. When output has finished, span calibration will start automatically.



If "BUSY" is displayed...

There is something placed on the pan. When this item is taken off the pan, span calibration will start automatically. To cancel scan calibration, press .



If "ERR H" is displayed...

See "Responding to Messages" (👉 page 137).



If "ERR C" is displayed...

Span calibration was not completed for one of the following reasons.

- ◆ There is too large a discrepancy between the zero point of the balance and the sensitivity.
- ◆ A container has been placed on the pan.
- ◆ The pan is not on the balance.
- ◆ There is too large a discrepancy in the value of the internal weight.

Press  and redo the operation from the beginning. If even on doing this the same display reappears, calibrate the internal weight (👉 page 64).



* This may not be displayed.



"END" will be displayed and the balance will return to the weighing mode.

⚠ Caution



Instructions

If calibration doesn't end normally and the balance stops, do not move it nor leave it as it is.

Moving the balance in such a condition may cause failure because the internal weight is not held correctly.

Before moving the balance, be sure to turn the power on and start it up correctly (so that the internal weight is correctly held).

◆ TX/TXB Series

1

Press 

The weight value will flash.





If "WAIT" is displayed...

The calibration record is being output. When output has finished, span calibration will start automatically.



If "BUSY" is displayed...



There is something placed on the pan. Take the item off the pan and follow the procedure below.

To cancel scan calibration, press 
( with the TXB series).



If no operation is performed within 60 seconds...

"ERR C" (calibration error) is displayed.

Press  ( with the TXB series) and repeat the operation from the beginning.

2 Enter the weight value.

If necessary, change the weight value to match the weight that will be used for calibration. If there is no need to change it, proceed to step 3.

MENU ENTER (If necessary enter the weight value.) MENU ENTER

 "Entering Numerical Values", page 49

For details on the weight values that can be entered, see "Specifications" ( page 145).



With models that don't feature the windbreak

3 Place the calibration weight on the pan.



Wait until the flashing weight value display changes to a flashing zero.



If "ERR C" is displayed...

Span calibration was not completed for one of the following reasons.

- ◆ There is too large a discrepancy between the zero point of the balance and the sensitivity.
- ◆ A container has been placed on the pan.
- ◆ The pan is not on the balance.
- ◆ The wrong weight has been placed on the pan.
- ◆ No operation has been performed within 60 seconds of the flashing weight value or zero display.

Press   with the TXB series) and repeat the operation from the beginning.

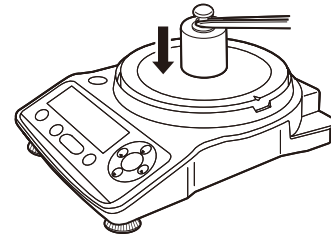

4 Take the weight off the pan.

"END" will be displayed and the balance will return to the weighing mode.

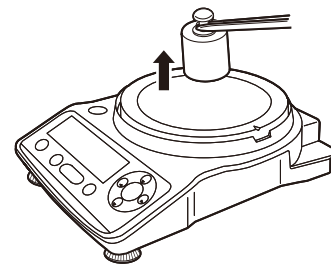

With models that feature the windbreak

3 Place the calibration weight on the pan.

Open the glass door in the windbreak, place the weight on the pan, and shut the glass door again.

Wait until the flashing weight value display changes to a flashing zero.



Shut the glass door fully.

After placing a weight on the pan or removing a weight from the pan, check that the glass door is fully shut.

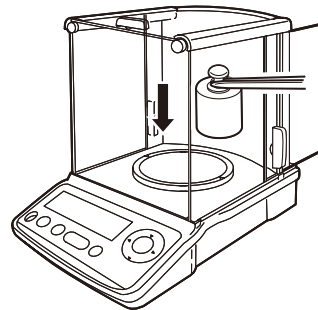

4 Take the calibration weight off the pan.

Open the glass door in the windbreak, remove the weight from the pan and shut the glass door again.

"END" will be displayed and the balance will return to the weighing mode.

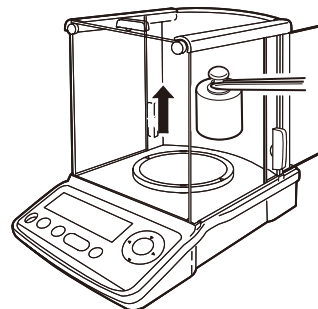

The procedure described above is the default standard span calibration procedure.

For details, see "4. CALIBRATION" (📖 page 54).

2 USING THE BALANCE

Weighing

1 Enter the weighing mode.



What is the weighing mode?

The balance is in the state where it indicates the units (for example grams) of the weight on the pan.

To establish the weighing mode, follow the steps below depending on the current status of the balance.

Status of the Balance	To Establish the Weighing Mode....
The display is off.	Press (with the TXB series). When the "OFF" indication appears or all segments are lit, press any key.
"OFF" indication, all segments lit, or READY (ready symbol) lit	Press any key.
The application function mode is established.	Press
A menu indication is displayed.	Press for about 3 seconds.
The balance is accepting numerical value entry.	Press (with the TXB series) to cancel numerical value entry, then press for about 3 seconds.

With models that don't feature the windbreak

2 Place a container on the pan.

3 Once the display has stabilized (→ has lit), press

The indication changes to zero.

4 Insert the sample (item to be measured) into the container.

5 When the display has stabilized, (the stability mark) lights up, read the display.

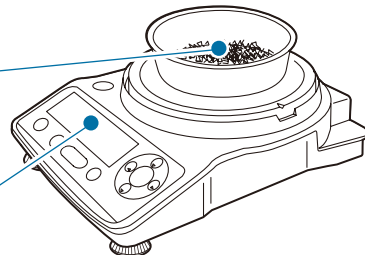
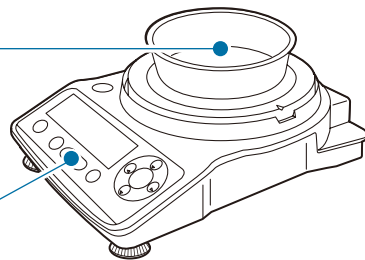



If an indication like "OL" or "-OL" appears during measurement...

See "Responding to Messages" (👉 page 137).

With models that feature the windbreak

2 Place a container on the pan.

Open the glass door in the windbreak, place the container on the pan and shut the glass door again. With the TXC323L and TXC623L, the pan with grip supplied as a standard accessory can be used.

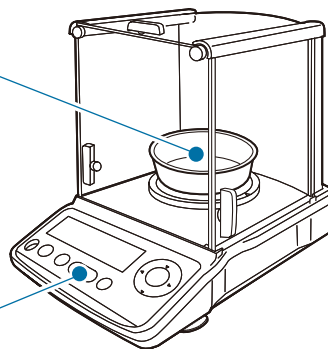

3 Once the display has stabilized (→ has lit), press

The indication changes to zero.

4 Insert the sample (item to be measured) into the container.

Open the glass door of the windbreak, place the sample (item to be weighed) on the pan and shut the glass door again.

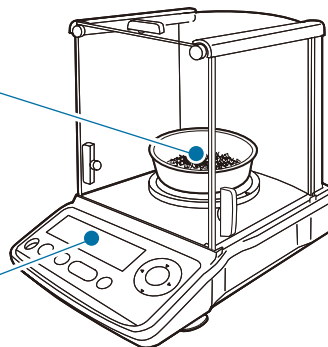

5 When the display has stabilized, → (the stability mark) lights up, read the display.



Shut the glass door fully.

Check that the glass door is fully shut before reading the balance display.



With the TWC**3L, TXC**3L...

Avoid doing the following:

- ◆ Putting your hand inside the glass door of the windbreak
- ◆ Touching the container or sample with bare hands
- ◆ Weighing samples (items to be weighed) of different temperatures

The heat will lead to convection, and this may make the balance display unstable.

Use forceps or gloves to carry containers and samples.

When dealing with samples (items to be weighed) at different temperatures, eliminate the temperature difference by leaving the samples around the pan inside the glass door before weighing.

Outputting Weight Readings

When the balance is connected to a PC and a printer (option), you can output a weight reading, settings, and so on for each measurement. The WindowsDirect communication function (👉 page 111) is convenient for output to a PC.

- When the GLP output function (👉 page 142) is set to OFF, only the weight reading is output.
- When the GLP output function (👉 page 142) is set to ON, the following information is output.

Example printout from printer
(When the GLP output function is set to ON)

The diagram shows a rectangular printout area with a wavy bottom edge. On the left, there are labels with lines pointing to specific fields in the printout. The printout itself contains the following text:

• SHIMADZU CORP.
• TYPE TX323L
• SN D465412345
• ID 1234

• 300.000g
-SIGNATURE-

Labels on the left:

- Name of manufacturer
- Balance model name
- Balance serial number
- Balance ID
- Weight reading
- The person who carried out measurement signs here.

Selecting the Display

Switching Units

You can display different units from among those set to be available.

1 Press **UNIT** in the weighing mode.

Repeatedly pressing this key will cycle you through the registered units.

When the balance is shipped from the factory, the only unit registered is grams (for TWC**3L and TXC**3L, "g" and "ct" only).

To be able to switch to other units, you must first register the units you wish to use.

 "Selecting Units to Display", page 83

When user-specified units have been selected, the characters and symbols that indicate the units don't light up.

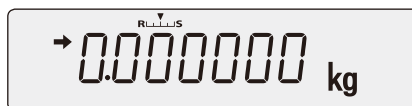

Unit display after restarting

When the power is turned off and back on, the balance starts up displaying the units that were in use before the power was turned off.

Selecting the Minimum Number of Displayed Digit

If necessary, the minimum number of displayed digit can be reduced by one digit.

1 Press **FUNC** for about 3 seconds.

The minimum number of displayed digit will be reduced by one.



2 Press **FUNC** again for about 3 seconds.

The minimum number of characters displayed will return to the original setting.



Display after selection

The decimal place doesn't change. Note also that when one digit is removed the display area for the final digit appears as a blank.

▽ Selecting the Display

■ Selecting the Decimal Point Display Symbol

The decimal point can be displayed as either "." (a period) or "," (a comma).

1 Press  in the weighing mode.

This opens the main menu.

2 Select decimal point display setting.

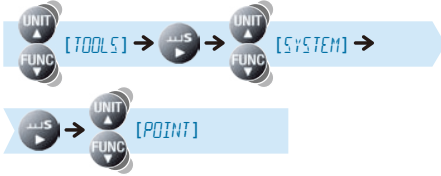

3 Select the decimal point display symbol.

To select "." (period):



To select "," (comma):

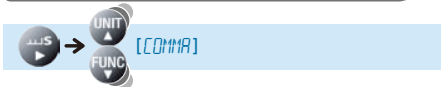

When outputting to the ER-50/EP-60A electronic printer (old type)...

Do not select "," (comma). The printer may not print it correctly.

4 Confirm and return to the weighing mode.



The way the decimal is displayed has now changed.



• To select the period



• To select the comma



Selecting the decimal point display symbol

When the decimal point display is changed, the decimal point changes accordingly in data output to external devices such as printers.

Ending Weighing

Turning the Power OFF

1 Establish the weighing mode.

 "Weighing", page 38

2 Press 

If the status described below is not established, press  again.

With the TW/TX Series...

READY (the ready symbol) will light and the standby mode will be established.

Normally, leave the balance on standby in this state until the next weighing.

To shut the power off completely, disconnect the AC adapter.

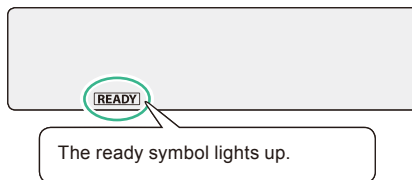

? What is the standby mode?

This is the status in which the balance stands by, saving electricity although it can still be used right away.

On pressing  in the weighing mode the display is turned off, **READY** (the ready symbol) is lit and the power saving status (standby mode) is established.

During the standby mode, the interior of the balance is powered and in the warming-up status, ready for immediate use.

(* The standby mode is a function featured with the TW/TX Series only.)

With the TXB Series...

The power is shut off. The standby mode is not established.

Normally, leave the balance in this state until the next weighing.

If batteries are installed in the balance and it is not going to be used for a long time, remove the batteries.

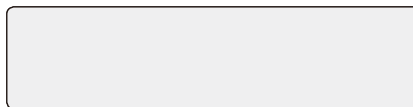

▽ Ending Weighing

Caution



Prohibitions

While [WAIT] or [SET] is displayed, on no account disconnect the AC adaptor or remove the batteries.

There is a risk that data in the scale will be corrupted.

BEFORE
WEIGHING

USING THE
BALANCE

USING MORE CONVENIENTLY

MAINTENANCE

TROUBLESHOOTING

FOR YOUR
INFORMATION

MEMO

3 MENU SETTINGS

What Is the Menu?

With the TW/TX/TXB series, the menu is used to efficiently select the right functions for the user's application.

The Structure of the Menu

The menu is divided into five groups according to the setting made.

Menu Group	Description
Main menu	Used to set the application function mode, comparator, stability adjustment, etc.
Calibration menu	Used to set the details for calibration
Zero / tare menu	Used to set the details for taring
Data output menu	Used to set the functions for transmitting data to a PC or outputting them to a printer
Unit setting menu	Used to set which units may be displayed in weighing mode

You can open each menu group by pressing the various operation keys and menu operation keys.

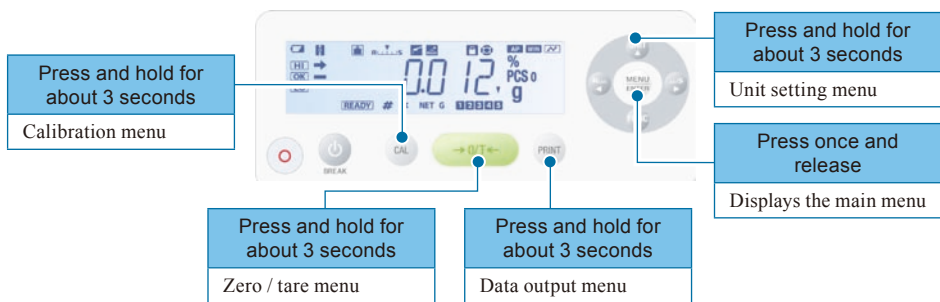

Within each menu group are a number of hierarchical menu levels.

You can move between levels in the menu hierarchy by pressing **RECALL** and **ENTER**.

You can scroll through the options within each level of the hierarchy by pressing **UNIT** or **FUNC**.

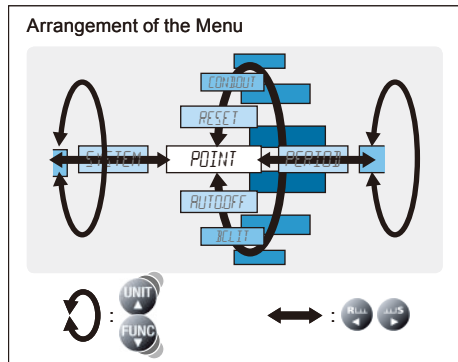

Menu Map

The menu map represents the organization of the menu options graphically to make it easy to understand.

It is useful for quickly accessing the menu option you want to use.

For more on the menu map, see "Menu Map" (📖 page 150) and "Menu Map Sheet".

Instruction Manual

The instruction manual describes specific parts of the menu operations in a simplified form.

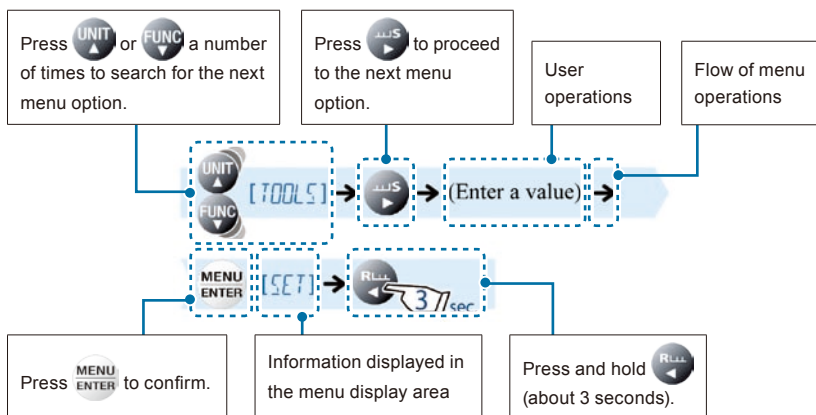

Menu Operation Key Symbol

On entering menu operation,  (the menu operation key mark) lights up.

The keys represented by lid segments can be used.

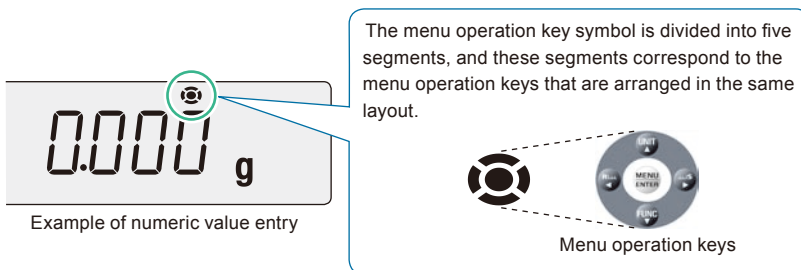

Basic Menu Operations

1 Open the target menu from the weighing mode.

The method used to open a menu option differs depending on the group.

For details on the methods used for menu opening from each group, see "The Structure of the Menu" (👉 page 46).

2 Set menu options by pressing the menu operation keys.

The menu operation keys are used to set functions and to enter numerical values.

For details on how to operate the menu operation keys, see "What Is the Menu?" (👉 page 46).

For details on the operating procedure for entering numerical values, see "Entering Numerical Values" (👉 page 49).

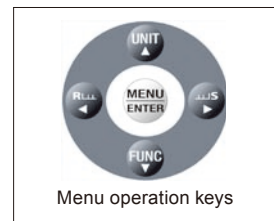

For a menu option that is already set...

➡ (the stability mark) appears in the menu display.

3 Confirm and return to the weighing mode.

The operation after confirming the menu selection differs depending on the menu, and you will either be returned to the weighing mode automatically or will need to do it manually.

To return manually, press  3/sec. for approximately 3 seconds.



If you open the menu again...







The recently set menu option will be displayed first.

Note also that, when the set menu option is displayed, ➡ (the stability mark) also appears.

Entering Numerical Values

Numerical values sometimes have to be entered for menu settings, for example the weight value of a calibration weight, condition values for operating functions, the balance ID, passwords, etc.

◆ Operations of the operation keys

Operation Key	Operation During Numerical Value Entry
	Confirms the entered numerical value
	Increases the value of the digit to be entered (the flashing digit) Pressing this key while the decimal point is flashing shifts the decimal point to the left.
	Decreases the value of the digit to be entered (the flashing digit) Pressing this key while the decimal point is flashing shifts the decimal point to the right.
	Shifts the digit to be entered (the flashing digit) one digit to the left
	Shifts the digit to be entered (the flashing digit) one digit to the right
	Cancels entry

■ Changing the Numerical Value

As an example, here is the procedure for changing "120.000 g" to "200.000 g".

- 1 Enter the numeric value entry mode.

(the number symbol) lights and the leftmost digit (highest digit) in the range where the value can be changed flashes.



- 2 Press  once.

The numerical value of the flashing digit increases by one, so that it changes from "1" to "2".



- 3 Press 

The flashing shifts to the second digit from the left.



▽ Entering Numerical Values

- 4** Press  twice.
The numerical value of the second digit from the left decreases two times, so that it changes from "2" to "1" to "0".



- 5** Press .
This confirms the entered numerical value. The indication shown to the right remains displayed for several seconds, then the display automatically moves on to the next step.



■ Changing the Position of the Decimal Point

The position of the decimal point can only be changed when entering a conversion factor with the user-specified units.

 "Conversion Factors", page 84



As an example, here is the procedure for shifting the position of the decimal point one digit to the left, to change the displayed value from "100.000" to "10.0000".

- 1** Establish the numeric value entry mode.
(the number symbol) lights and the leftmost digit (highest digit) in the range where entry (change) is possible flashes.





- 2** Press  several times until the decimal point flashes.



- 3** Press  or  several times.
This will move the decimal point to the left or right.



To set a numerical value with no decimal point...

Press  several times until  (the inverse triangle symbol) flashes.

- 4** Press .
This confirms the entered numerical value. The indication shown to the right remains displayed for several seconds, then the display automatically moves on to the next step.



Convenient Functions for Menu Setting

Returning to the Default Settings (Menu Reset)

If you want to return the menu settings to the default settings, reset the menu.

The default settings are indicated by asterisks in the menu map (👉 page 150) and on the menu map sheet.

1 Press  in the weighing mode.

This opens the main menu.

2 Select menu reset.

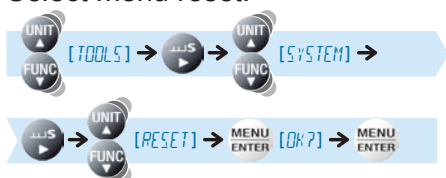

RESET

OK?

3 Enter the password.

The password is set to "9999" before shipment. If the default setting is not changed, enter "9999".

👉 "Entering Numerical Values", page 49

👉 "Changing the Password", page 141

P- 00:10
#

4 Confirm.

 [WAIT] [SET]

The default menu settings are reinstated and the balance automatically returns to weighing mode.

WAIT

SET

Prohibiting Changes to the Menu Settings (Menu Lock)

In order to ensure that the menu settings are not changed by mistake, the person managing the balance controls the password and can prohibit menu operation.

The default password is "9999". To change the password, see "Changing the Password" (👉 page 141).



Operation in the menu lock status

Even when the menu is locked it is possible to perform calibration (CAL), change the weight value, and switch the weighing mode and application function mode (FUNC).

- 1 Press **MENU ENTER** 3 sec. until the display changes (about three seconds) while "OFF" is displayed after supplying power or while in the standby mode.



With the TXB series the balance doesn't go into the standby mode.

If the "OFF" display doesn't appear, see "Setting the Startup Display" (👉 page 139).

- OFF display after supplying power



- Standby mode



- 2 Enter the password.

👉 "Entering Numerical Values", page 49



- 3 Press **MENU ENTER**

The password will be accepted. The menu will be locked and the display will return to the indication in step 1.

If the password is wrong...

The error message shown to the right will be displayed and the display will return to the indication in step 1.



The menu lock symbol will light up.



- 4 Confirm.

On entering the weighing mode...

🔒 (the menu lock symbol) is shown in the display.

On pressing any menu operation key...

"LOCKED" is displayed and menu operation is not possible.





Releasing the menu lock

To release the menu lock, perform steps **1** through **3** again.

Outputting the Menu Setting Information

You can output the menu settings to make a record of the balance settings.

- 1 Connect the balance to a PC or printer (option).

"10. CONNECTION AND COMMUNICATION WITH PERIPHERAL DEVICES", page 106

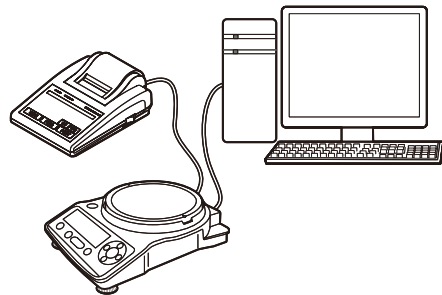

- 2 Press in the weighing mode. This opens the main menu.

- 3 Select output of menu setting information.

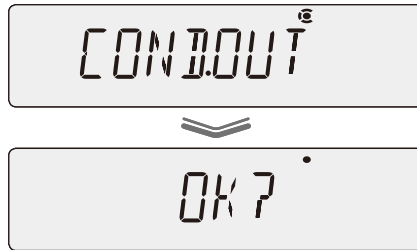
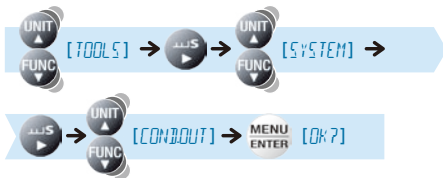

To output the settings, proceed to step **4**.

To cancel, press (with the TXB series).

- 4 Confirm.



On confirmation, the menu setting information is output to the PC or printer.

On completion of output, the balance returns to weighing mode.

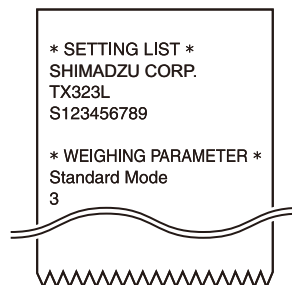

4 CALIBRATION

In order to weigh accurately with an electronic balance, the balance must be calibrated after it has been moved or if the room temperature has changed substantially.

You are also advised to carry out calibration routinely (before use every day).

Before Starting Calibration...

Two kinds of calibration operation are possible with the TW/TX/TXB series: "span calibration" and the "calibration check", and for each of them you can select the use of either the internal weight (TW only) or the external weight.

By registering either of these for **CAL**, the registered operation can be started by just pressing **CAL**.

Span calibration	Adjust to achieve correct balance sensitivity using either the internal weight (TW only) or the external weight. Drift in the sensitivity is corrected (default setting).
Calibration check	Investigate the drift in the balance's sensitivity by using either the internal weight (TW only) or the external weight.



The operation to calibrate the internal weight itself cannot be registered in **CAL**.

To calibrate the internal weight itself, refer to "Calibration of the Internal Weight (TW Only)" (page 64).

Use the following procedure to set the preferred operation for **CAL**.

- Press **CAL** for about 3 seconds.
This opens the calibration menu.
- Select either "span calibration" or "calibration check".

Example of registering "span calibration using the internal weight"



Example of registering "span calibration using the external weight"



Example of registering a "calibration check using the internal weight"

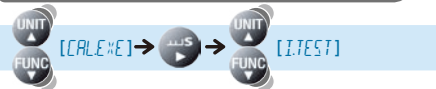

Example of registering a "calibration check using the external weight"

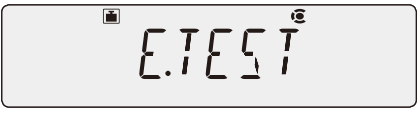
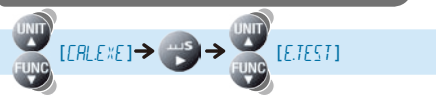

3 Confirm and return to the weighing mode.



"Span calibration" or "calibration check", whichever was selected in step 2, is set for CAL and the balance returns to the weighing mode.

- When "span calibration using the external weight" has been selected



When executing "span calibration", see "Span Calibration and Adjustment" (page 56).
When executing a "calibration check", see "Calibration Check" (page 60).

Span Calibration and Adjustment

Adjust to achieve correct balance sensitivity using either the internal weight (TW only) or the external weight.



Set the relevant "span calibration" in **CAL** in advance by following the procedure in "Before Starting Calibration ..." (👉 page 54). (As the default setting, "span calibration using the internal weight" is set for TW, and "span calibration using the external weight" is set for TX.)

◆ Span calibration using the internal weight (TW series only) **I.CAL**

1 Press **CAL**

Span calibration using the internal weight will start automatically.

 If "WAIT" is displayed...
The calibration record is being output. When output has finished, span calibration will start automatically.

 If "BUSY" is displayed...
There is something placed on the pan. When this item is taken off the pan, the span calibration will start automatically. To cancel the span calibration, press .

 If "ERR H" is displayed...
See "Responding to Messages" (👉 page 137).

 If "ERR C" is displayed...
Span calibration was not completed for one of the following reasons.

- ◆ There is too large a discrepancy between the zero point of the balance and the sensitivity.
- ◆ A container has been placed on the pan.
- ◆ The pan is not on the balance.
- ◆ There is too large a discrepancy in the value of the internal weight.

Press  and redo the operation from the beginning. If even on doing this the same display reappears, calibrate the internal weight (👉 page 64).



* This may not be displayed.



"END" will be displayed and the balance will return to the weighing mode.

⚠ Caution



Instructions

If calibration doesn't end normally and the balance stops, do not move it nor leave it as it is.

Moving the balance in such a condition may cause failure because the internal weight is not held correctly.

Before moving the balance, be sure to turn the power on and start it up correctly (so that the internal weight is correctly held).

◆ Span calibration using the external weight **E.CAL**

1 Press **CAL** in the weighing mode.

When the GLP output function ( page 142) has been set to ON, initially the indication "WAIT" is displayed, then the balance model name and other information is output.

After a little while  (the weight symbol) lights up and the weight value of the weight to be placed on the pan flashes.



If "WAIT" is displayed...

The calibration record is being output. When output has finished, span calibration will start automatically.



If "BUSY" is displayed...

There is something placed on the pan. Take the item off the pan and follow the procedure below.

To cancel scan calibration, press  (with the TXB series).





If no operation is performed within 60 seconds...

"ERR C" (calibration error) is displayed.

Press  (with the TXB series) and repeat the operation from the beginning.

2 Enter the calibration weight value.

If necessary change the weight value displayed to match the weight that will be used for calibration. If there is no need to change it, proceed to step 3.

 (Enter a weight value if necessary.) 

 "Entering Numerical Values", page 49

For details on the range of weight values that can be used, see "Specifications" ( page 145).



With models that don't feature the windbreak

3 Place the calibration weight on the pan.

Wait until the flashing weight value display changes to a flashing zero.



4 Take the calibration weight off the pan.



"END" will be displayed and the balance will return to the weighing mode.



If "ERR C" is displayed...

Calibration has failed for one of the reasons given below.

- ◆ There is too large a discrepancy between the zero point of the balance and the sensitivity.
- ◆ A container has been placed on the pan.
- ◆ The pan is not on the balance.
- ◆ The wrong weight has been placed on the pan.
- ◆ No operation has been performed within 60 seconds of the flashing weight value or zero display.

Press  ( with the TXB series) and repeat the operation from the beginning.

With models that feature the windbreak

3 Place the weight on the pan.

Open the glass door in the windbreak, place the weight on the pan, and shut the glass door again. Wait until the flashing weight value display changes to a flashing zero.



Shut the glass door fully.

After placing a weight on the pan or removing a weight from the pan, check that the glass door is fully shut.

4 Take the calibration weight off the pan.

Open the glass door in the windbreak, remove the weight from the pan and shut the glass door again.

"END" will be displayed and the balance will return to the weighing mode.



With the TWC**3L, TXC**3L...

Avoid doing the following:

- ◆ Putting your hand inside the glass door of the windbreak
- ◆ Touching the container or sample with bare hands
- ◆ Weighing samples (items to be weighed) of different temperatures

The heat will lead to convection, and this may make the balance display unstable.

You are recommended to use forceps or gloves to carry containers and samples.

When dealing with samples (items to be weighed) at different temperatures, eliminate the temperature difference by leaving the samples around the pan inside the glass door before weighing.

BEFORE
WEIGHING

USING THE
BALANCE

USING MORE CONVENIENTLY

MAINTENANCE

TROUBLESHOOTING

FOR YOUR
INFORMATION

Calibration Check

This means checking for drift in the sensitivity of the balance by using the internal weight (TW only) or the external weight.

Set "calibration check" for **CAL** in advance by following the procedure in "Before Starting Calibration ..." (👉 page 54). (As the default setting, "span calibration" is set.)

◆ Calibration check using the internal weight (TW series only) **I.TEST**

1 Press **CAL**

A calibration check using the internal weight will start automatically, and the sensitivity drift will be displayed.



If "WAIT" is displayed...

The calibration record is being output. When output has finished, span calibration will start automatically.





If "BUSY" is displayed...

There is something placed on the pan. When this item is taken off the pan, the calibration check will start automatically.

To cancel the calibration check, press



If there is no need to change the sensitivity drift...

On pressing   with the TXB series) "ABORT" is displayed and calibration check ends.

👉 "What is sensitivity drift?", page 63



If "ERR H" is displayed...

See "Responding to Messages" (👉 page 137).







If "ERR C" is displayed...

The calibration check has failed for one of the reasons given below.

- ◆ There is too large a discrepancy between the zero point of the balance and the sensitivity.
- ◆ A container has been placed on the pan.
- ◆ The pan is not on the balance.
- ◆ There is too large a discrepancy in the value of the internal weight.

Press  and redo the operation from the beginning. If even on doing this the same display reappears, calibrate the internal weight ( page 64).

2

Press  CAL

"END" will be displayed. The sensitivity drift is adjusted and the balance will return to the weighing mode.



Caution



Instructions

If calibration doesn't end normally and the balance stops, do not move it nor leave it as it is.

Moving the balance in such a condition may cause failure because the internal weight is not held correctly.

Before moving the balance, be sure to turn the power on and start it up correctly (so that the internal weight is correctly held).

BEFORE
WEIGHING

USING THE
BALANCE

USING MORE CONVENIENTLY

MAINTENANCE

TROUBLESHOOTING

FOR YOUR
INFORMATION



◆ Calibration check using the external weight **E.TEST**



1 Press **CAL** in the weighing mode.

 (the weight symbol) will light up and the value of the weight that should be placed on the pan will flash.



 **If "WAIT" is displayed...**
The calibration record is being output. When output has finished, span calibration will start automatically.



 **If "BUSY" is displayed...**
There is something placed on the pan. Take the item off the pan and follow the procedure below.
To cancel calibration check, press  ( with the TXB series).



 **If no operation is performed within 60 seconds...**
"ERR C" (calibration error) is displayed. Press  ( with the TXB series) and repeat the operation from the beginning.

2 Enter the calibration weight value.

If necessary change the weight value displayed to match the weight that will be used for calibration. If there is no need to change it, proceed to step **3**.



 (Enter a weight value if necessary.) 

 "Entering Numerical Values", page 49
For details on the range of weight values that can be used, see "Specifications" ( page 145).

3 Place the calibration weight on the pan.

Wait until the flashing weight value display changes to a flashing zero.





With models that feature the windbreak...



After placing a weight on the pan or removing a weight from the pan, check that the glass door is fully shut.



If "ERR C" is displayed...

Calibration check has failed for one of the reasons given below.

- ◆ There is too large a discrepancy between the zero point of the balance and the sensitivity.
- ◆ A container has been placed on the pan.
- ◆ The pan is not on the balance.
- ◆ The wrong weight has been placed on the pan.
- ◆ No operation has been performed within 60 seconds of the flashing weight value or zero display.

Press  ( with the TXB series) and repeat the operation from the beginning.

4

Take the calibration weight off the pan.

The sensitivity drift is displayed.



If there is no need to change the sensitivity drift...

On pressing  ( with the TXB series) "ABORT" is displayed and calibration check ends.

5

Press 

"END" will be displayed. The sensitivity drift is adjusted and the balance will return to the weighing mode.



What is sensitivity drift?

The sensitivity drift is the amount by which the balance weight reading is off the true value when a weight close to the weighing capacity is placed on the pan. For example, with the TX323L (weighing capacity of 320 g, minimum display digit of 0.001 g), if a 300 g weight is placed on the pan after a drift of "–0.005 g" has been indicated, the weight reading will be "299.995 g".

To correct sensitivity drift by adjustment, perform "span calibration" ( page 56).

Calibration of the Internal Weight (TW Only)

In the TW series, the weight for calibration is built in. The internal weight itself is calibrated on shipment from the factory, but it is possible to recalibrate it using external weights. This is called **P.CAL**. For the range of values for the external weights that can be used, refer to "Specifications" (👉 page 145).

1 Press  for about 3 seconds.
 This opens the calibration menu.

2 Select calibration of the internal weight.

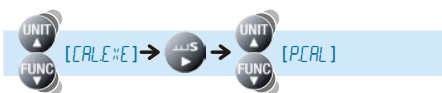

3 Enter the administrator's password.
 👉 "Entering Numerical Values", page 49
 👉 "Changing the Password", page 141



4 Press .
 The password is acknowledged and the reference weight value for calibration flashes.





 If "WAIT" is displayed...
 The calibration record is being output.
 When output has finished, span calibration will start automatically.

If the password is wrong...
 The error message shown to the right will be displayed and the display will return to the indication in step **1**.



5 If necessary, enter a weight value.

If no change is to be made, proceed to step 6 without doing anything.

 (If necessary, enter a weight value.) 

 "Entering Numerical Values", page 49

For the range of weight values that can be used, refer to "Specifications" ( page 145).

6 Place the weight on the pan.

Wait until the flashing weight value indication changes to a flashing zero indication.



If "ERR C" is displayed...

The internal weight has not been calibrated for one of the following reasons.

- ◆ The wrong weight has been placed on the pan.
- ◆ No operation has been performed within 60 seconds of the flashing weight value or zero display.

Press  and repeat the operation from the beginning.



BEFORE
WEIGHING

USING THE
BALANCE

USING MORE CONVENIENTLY

MAINTENANCE

TROUBLESHOOTING

FOR YOUR
INFORMATION

▽ Calibration of the Internal Weight (TW Only)

7 Take the calibration weight off the pan.

Open the glass door of the windbreak, take the weight off the pan, and close the glass door.



If "BUSY" is displayed...

There is something placed on the pan. When this item is taken off the pan, internal weight calibration will start automatically.

To cancel internal weight calibration, press 



If "ERR H" is displayed...

See "Responding to Messages" ( page 137).



If "ERR C" is displayed...

The internal weight has not been calibrated for one of the following reasons.

- ◆ There is too large a discrepancy between the zero point of the balance and the sensitivity.
- ◆ A container has been placed on the pan.
- ◆ The pan is not on the balance.
- ◆ There is too large a discrepancy in the value of the internal weight.

Press  and repeat the operation from the beginning.



* This may not be displayed.



"END" is displayed, then span calibration using the internal weight starts.

When span calibration using the internal weight ends, the balance returns to the weighing mode.

 "Span Calibration and Adjustment" page 56

Caution



Instructions

If calibration doesn't end normally and the balance stops, do not move it nor leave it as it is.

Moving the balance in such a condition may cause failure because the internal weight is not held correctly.

Before moving the balance, be sure to turn the power on and start it up correctly (so that the internal weight is correctly held).

Leaving a Record of Calibration

You can leave a record of execution of calibration and set an ID for a balance to facilitate management of multiple balances.

Example Printout of a Calibration Record

You can output a record of execution of calibration to a PC or printer (option).

The WindowsDirect communication function ( page 111) is useful for output to a PC.

The output calibration record includes the following items.

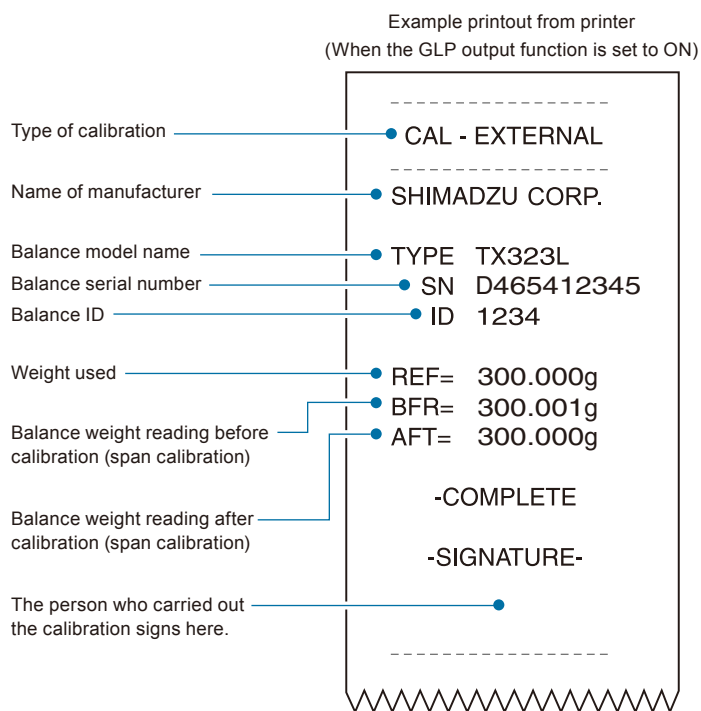

Outputting the date and time

Since the TW/TX/TXB series doesn't incorporate a clock function, it is not possible to output the date and time from the balance.

■ Setting Output of a Calibration Record

Output of the calibration record can be set by turning the GLP output function (👉 page 142) ON and OFF.

1 Press  **3** sec. for about 3 seconds.
This opens the calibration menu.

2 Select the GLP output function.

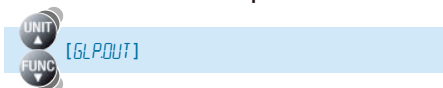

Stability Mark	GLP Output Function
Lit	ON
Unlit	OFF

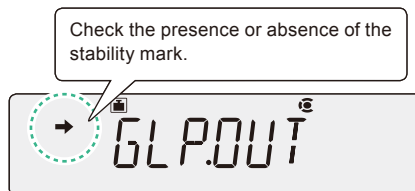

3 Change the setting.

Pressing  alternately sets the ON and OFF settings.

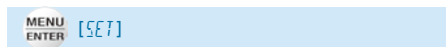

4 Return to the weighing mode.

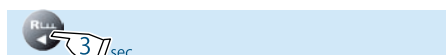

■ Setting a Balance ID

When managing multiple balances, you can set a four-digit management number (ID) for each balance which will be indicated as part of calibration records output.

1 Press  in the weighing mode.

This opens the main menu.

2 Select setting of a balance ID.

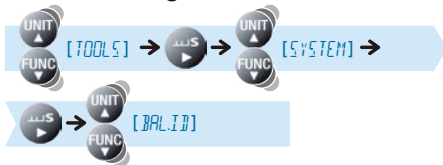

3 Enter the required numerals (max. 4 digits).

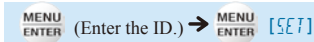

 "Entering Numerical Values", page 49

The default ID is "0000".





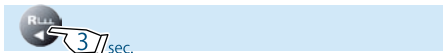

4 Return to the weighing mode.



5 FUNCTIONS RELATING TO TARING

The TX/TXB series has the following functions relating to the zero point and taring.
Make use of these functions in accordance with the weighing environment and the application.

Zero / Taring Functions

<h4 style="text-align: center; margin: 0;">Zero tracking function</h4> <p>Fluctuations in the zero point that occur immediately after turning the power ON and as a result of temperature changes are compensated for, so the zero indication is maintained.</p> <p style="text-align: right;"> page 71</p>	<h4 style="text-align: center; margin: 0;">Auto zero function</h4> <p>Drift of the zero point that occurs as a result of material left on the pan after measurement is automatically compensated for.</p> <p style="text-align: right;"> page 72</p>
<h4 style="text-align: center; margin: 0;">Auto tare function</h4> <p>After outputting a weight reading, taring is executed automatically.</p> <p style="text-align: right;"> page 74</p>	<h4 style="text-align: center; margin: 0;">Zero / tare timing change function</h4> <p>After waiting for  (the stability mark) to light up, zero point setting / taring is executed.</p> <p style="text-align: right;"> page 75</p>



What is taring?

This is a function whereby the weight of the container placed on the pan is subtracted to set the display to zero, so that only the weight of the sample placed inside the container is indicated.



What is the zero point?

This means the state where nothing is placed on the pan, zero is indicated, and weighing can be started.

Zero Tracking Function

When the zero tracking function is set, when the indication is zero (including when taring is performed) the fluctuations in the zero point that occur immediately after turning the power ON and due to temperature changes and other factors are compensated for and the zero indication is maintained. (In the default setting the zero tracking function is ON.)

1 Check  (the zero tracking symbol) in the weighing mode.

Zero Tracking Symbol	Zero Tracking Function
Lit	ON
Unlit	OFF

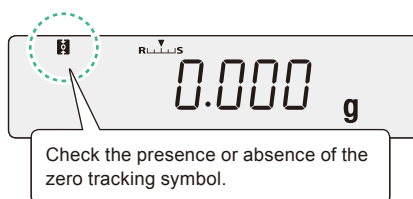

If you proceed to the next step while zero tracking is ON, it goes OFF.

2 Press 

This opens the main menu.



Setting from the zero / taring menu

You can also press  for about 3 seconds and make the setting from the zero / taring menu.

3 Select the zero tracking function.

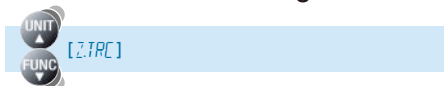

4 Confirm the ON or OFF selection.

The ON or OFF status will be selected and the balance will automatically return to the weighing mode.

After setting "ON",  (the zero tracking symbol) lights up.



When the setting has been made from the zero / taring menu

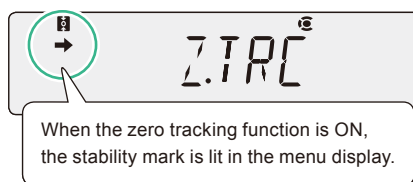
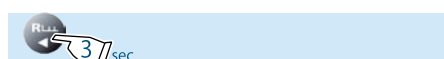

Auto Zero Function

When the auto zero function is set, any drift of the zero point that occurs as a result of material left on the pan after weighing is automatically compensated for so that zero is displayed.

Note that the auto zero function cannot be used in combination with formulation.

1 Press  for about 3 seconds in the weighing mode.

This opens the zero / taring menu.

2 Select the auto zero function.

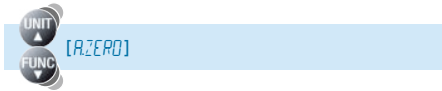



Check the presence or absence of the stability mark.



What is the current situation?

Stability Mark	Auto Zero Function
Lit	ID is ON
Unlit	ID is OFF

What do you want to do?

To set or Update...	To Cancel...
Press  and go to step 3.	Press  and go to step 4.
Press  and go to step 3.	Go to step 4.

3 Enter the value for the range for automatic compensation to the zero point (auto zero range).

(Enter the zero range value.) →  [SET]

 "Entering Numerical Values", page 49

If there is anything with a weight lower than or equal to the auto zero range value left on the pan after weighing the sample, it will automatically be compensated for and the zero point will be established when  (the stability mark) lights up.



When ON is set the stability mark is lit.



Auto zero range value

The auto zero range value is only effective in the units that are displayed when the value is entered.

If other units are later selected, change (update) the setting for the zero range value by following the procedure from step 1 while these new units are displayed.

The upper limit value for the zero range is 99 d. 1 d is the minimum indication in the displayed units.

For example, for a balance with a minimum indication of 0.001 g, the situation is as follows.

Units	Minimum Indication	Upper Limit Value for the Zero Range
g	0.001 g	0.099 g
ct	0.01 ct	0.99 ct

4

Return to the weighing mode.



BEFORE WEIGHING

USING THE BALANCE

USING MORE CONVENIENTLY

MAINTENANCE

TROUBLESHOOTING

FOR YOUR INFORMATION

Auto Tare Function

When the auto tare function is set, the balance is automatically tared after the weight reading has been output, and the indication at that point is set to zero.

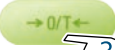
- 1** Press  for about 3 seconds in the weighing mode.

This opens the zero / taring menu.

- 2** Select the auto tare function.

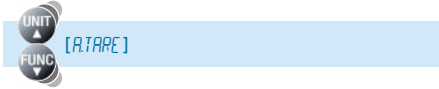

Stability Mark	Auto Tare Function
Lit	ON
Unlit	OFF

- 3** Change the setting.

Pressing  alternately sets the ON and OFF settings.



- 4** Return to the weighing mode.

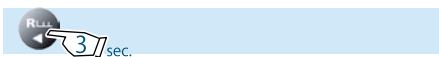





Check the presence or absence of the stability mark.



When ON is set the stability mark is lit.

Zero / Tare Timing Change Function

The zero / tare timing change function allows you to select whether setting of the zero point / taring is executed without waiting for  (the stability mark) to light up, or after waiting for  (the stability mark) to light up after pressing .

This function can also be applied to operations under the auto zero function and the auto tare function. (The default setting is for execution without waiting for  (the stability mark) to light up.)

1 Press  for about 3 seconds in the weighing mode.

This opens the zero / taring menu.

2 Select the zero / tare timing change function.



Stability Mark	Zero / Tare Timing Change Function
Lit	The balance doesn't wait for stability
Unlit	The balance waits for stability.



Check the presence or absence of the stability mark.

3 Change the setting.

Pressing  alternately selects the "wait for stability" and "don't wait for stability" settings.

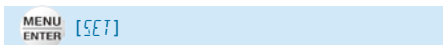

When "don't wait for stability" is selected, the stability mark lights up.

4 Return to the weighing mode.

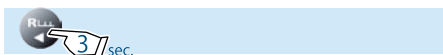

6 ADJUSTING RESPONSE AND STABILITY



The response and stability of the balance can be adjusted in several ways in accordance with the installation environment (degree of vibration and so on) and the weighing application (whether solid objects / clumps or poured liquids / powders are being weighed).

- Stability: The degree to which the weight reading is stable, with little fluctuation
- Response: The speed of the reaction to changes in the weight on the pan

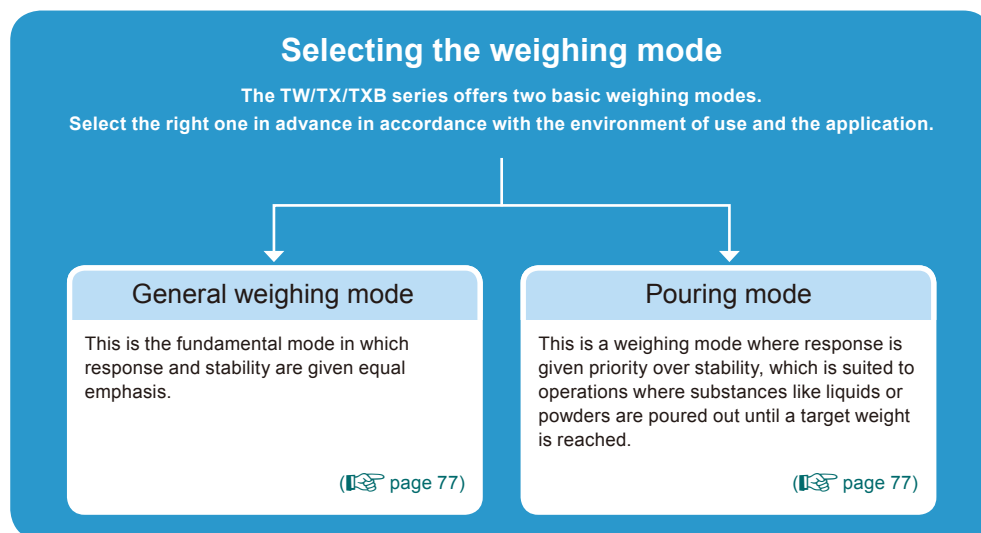
Set the optimum conditions for your application by following the procedure below.



Adjusting the response and stability in real time

The ratio of response to stability and stability can be changed in stages by pressing  and .

"Easy Setting of Response and Stability"  page 78

Adjusting → (the stability mark)

The conditions for making → (the stability mark) light up (the stability detection range and the stability mark lighting timing) can be adjusted.

"Adjusting the Stability Mark"  page 79

Selecting the Weighing Mode

TW/TX/TXB series balances have the following two types of weighing mode.

Set the right mode in advance depending on the environment of use and the weighing application.

Selecting the General Weighing Mode

This is the fundamental mode in which response and stability are given equal emphasis.

1 Press  in the weighing mode.

This opens the main menu.

2 Select the general weighing mode.



The balance has been set in the general weighing mode.



Selecting the Pouring Mode

This is the weighing mode suited to pouring out a sample (substance being weighed such as a powder or liquid) until a target weight is reached.

The update of the display is fast and the final value can be stabilized for reading.

1 Press  in the weighing mode.

This opens the main menu.

2 Select the pouring mode.



The pouring mode is established and  (the pouring symbol) lights up.

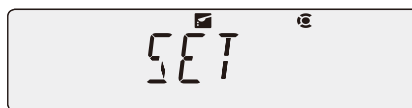

Easy Setting of Response and Stability

During weighing, the response and stability of the weighing mode can be adjusted in stages in accordance with the installation environment and the weighing application.

The TW/TX/TXB series balances feature excellent response and stability, but since response and stability are generally antagonistic, if one is prioritized it will to some extent weaken the characteristics of the other.

Easy Setting allows quick adjustment to match your preference, requirements or particular application.

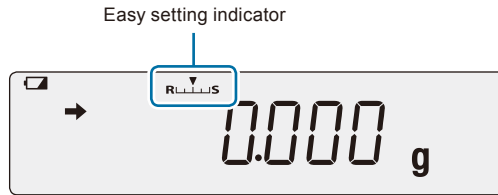

Priority Given to Response	↔	Priority Given to Stability
 R L L L L S	Easy setting indicator	 R L L L L S
Press The more times you press this key, the further ▼ (the level indicator) moves to the R side, increasing the response of the display in stages.	Operation	Press The more times you press this key, the further ▼ (the level indicator) moves to the S side, increasing the stability of the display in stages.
<ul style="list-style-type: none"> • When you want to weigh things quickly • When you want to improve working efficiency • When weighing out target quantities of a liquid or powder or when making a formulation 	For these circumstances...	<ul style="list-style-type: none"> • When you want to weigh things with confirmed accuracy • When the display is unstable • When the balance is used in a location where there is a constant and relatively large vibration • When the balance is subject to constant air movements and the indication wavers

Adjusting the Stability Mark

The stability mark is a symbol (➡) that is displayed when it is determined that the weight reading has stabilized.

The following settings adjust conditions for lighting up of ➡ (the stability mark).

- Stability detection range
- Stability mark lighting timing

Normally there is no need to change these settings. (Change the settings if, for example, you want to relax the conditions and make ➡ (the stability mark) light more easily because the environment is unstable, or to speed up operation if stability is used to automatically print or output data.



Lighting up of ➡ (the stability mark)

The lighting up of ➡ (the stability mark) indicates the fact that the weight reading is stable. If the load is being changed slowly, or due to the settings relating to stability detection, the weight reading may change while ➡ (the stability mark) remains lit, or ➡ (the stability mark) may light temporarily and then the weight reading may change.

Setting the Stability Detection Range

The stability detection range is a value set as a count of the smallest digit that is displayed, and the display is judged to be stable if fluctuation in the weight reading is within this count during a fixed time.

(The default setting for the stability detection range is 1 count (1d).)

Effect of reducing the stability detection range

It takes some time for ➡ (the stability mark) to light up, but after it has lit the weight reading is stable (improvement in reliability).

Effect of increasing the stability detection range

➡ (the stability mark) can be made to light more quickly but the weight reading is liable to fluctuate after it has lit (improvement of weighing and data output speeds).

1 Press  in the weighing mode.

This opens the main menu.

2 Select setting of the stability detection range.

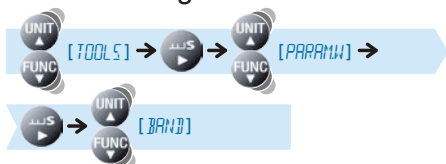

6 ADJUSTING RESPONSE AND STABILITY

▽ Adjusting the Stability Mark

3 Select the value for the stability detection range.

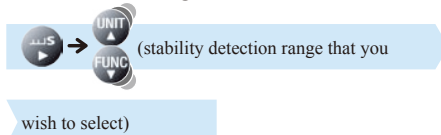

Select the stability detection range from among the following options depending on the weighing application and purpose: 0.5d, 1d, 10d, 50d, 100d, 1000d.

4 Confirm and return to the weighing mode.



The stability detection range has now been set.

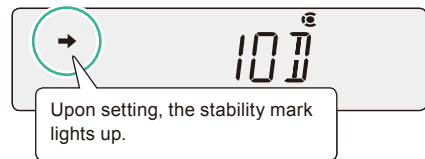





If data output is slow...

There are factors in the installation environment and the sample that make the display unstable. If data output triggered by stability detection is very slow, increase the stability detection range.

Setting the Stability Mark Lighting Timing

The timing according to which  (the stability mark) lights can be set in accordance with the application and required accuracy.

Effect of speeding up the timing for lighting up of the stability mark	At the same time as stability is detected,  (the stability mark) lights up. The weight reading after  (the stability mark) lights up becomes more susceptible to fluctuation since many samples can be weighed in succession and the working time can be used more efficiently (improvement of weighing speed).
Effect of setting the stability mark lighting timing to the standard setting	When stability is detected and remains detected for a fixed time,  (the stability mark) lights up.  (the stability mark) lighting judgments become stricter and the weight reading is stable after it has lit, so highly accurate weighing is possible (improvement of reliability of data).

1

 Press  in the weighing mode.

This opens the main menu.

2

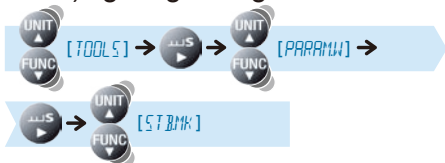
 Select setting of  (the stability mark) lighting timing.

3

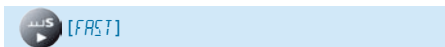
 Check the lighting timing setting.



Stability Mark	Stability Mark Lighting Timing
Lit	Fast
Unlit	Standard



Check the presence or absence of the stability mark.

4

 Change  (the stability mark) lighting timing.

Pressing  alternately sets the "fast" and "standard" settings.

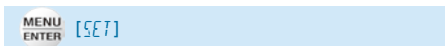

When the timing is set to "fast" the stability mark lights up.

5

 Return to the weighing mode.

7 SETTING UNITS

TW/TX/TXB series balances can be made to indicate weights in units other than the basic units of grams by switching units with the  key in the weighing mode.

You must register the units you will require in advance.

On shipment from the factory, the only unit registered is g (grams) (for the TWC**3L and TXC**3L, it is g and ct only).

 "Switching Units", page 41

Units That Can Be Displayed and Conversion Factors

Some of the units below cannot be selected in some countries due to legal restrictions.

Weight Unit (Weight Name)	Gram Conversion ^(*)	Conversion Factor ^(*)
g (gram)	1	1
mg (miligram) ^{*3}	0.001	1000
kg (kilogram) ^{*4}	1000	0.001
ct (carat) ^{*5}	0.2	5
mom (momme)	3.75	0.2666667
lb (pound)	453.592	0.00220462
oz (ounce)	28.34955	0.035274
ozt (troy ounce)	31.1035	0.0321507
dwt (pennyweight)	1.55517	0.643015
GN (grain)	0.064799	15.4324
HTI (Hong Kong tael)	37.429	0.0267173
STI (Singapore tael)	37.79936	0.0264554
TTI (Taiwan tael) ^{*6}	37.5	0.0266667
MTI (Malaysian tael)	37.79289	0.0264600
m (mesghal)	4.6083	0.216999
o (parts pound)	0.88592	1.12877
B (baht)	15.2	0.0657895
S (sawaran)	7.999	0.1250156
Ks (kyats)	16.606	0.0602191
T (tola)	11.664	0.0857339
User ^{*7}		Can be set as required by the user ^(*)

*1 If we take the value in the Gram conversion column to be "a", the formula is as follows.

"a" × balance weight reading (each unit) = value in gram units

*2 If we take the conversion factor to be "k", the formula is as follows.

"k" × value in gram units = balance weight value (selected units)

*3 mg cannot be selected on models whose minimum indication is 10 mg or greater.

*4 kg cannot be selected on the TWC**3L and TXC**3L.

*5 The minimum indication for ct (carat) may vary depending on the production lot even if they are the same model.

*6 There are five kinds of Taiwan tael (TTI-1 to TTI-4).

The conversion factor is the same, but the minimum indication is as follows.

TTI-1 A value 5 times that of TTI-2

TTI-2 The minimum value

TTI-3 A value twice that of TTI-2

TTI-4 A value 10 times that of TTI-2

*7 With user-specified units, the conversion factor (*2) and minimum indication can be set as required.

For details on the method for setting user-specified units, see "Setting User-Specified Units" ( page 84).

Selecting Units to Display

Select and set the units you require to display so that they can be called up by pressing  during weighing operation.

For details on user-specified units, see "Setting User-Specified Units" ( page 84).

- 1 Press  for about 3 seconds in the weighing mode.

This opens the unit setting menu.

- 2 Select the units to be called up and check if  (the stability mark) is displayed or not.

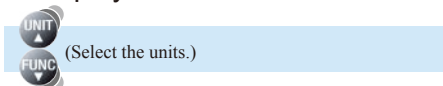

Stability Mark	Registering Units
Lit	ON
Unlit	OFF



Check the presence or absence of the stability mark.

- 3 Change the setting for units.

Pressing  alternately sets the ON and OFF settings.



To set or cancel other units, go to step 2.
To quit, go to step 4.



When ON is set the stability mark is lit.

- 4 Return to the weighing mode.



- 5 Press  to call up selected units.

 "Switching Units", page 41

Setting User-Specified Units

Conversion Factors

Numerical values (multipliers) by which the weight reading (in grams) is multiplied can be set without restriction.

1 Press  for about 3 seconds in the weighing mode.

This opens the unit setting menu.

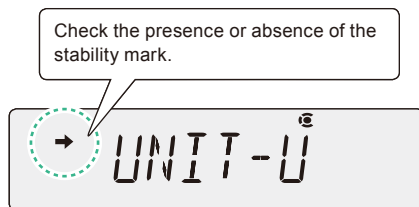
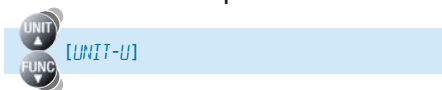

2 Select the user-specified units.



What is the current situation?

Stability Mark	User-Specified Units
Lit	Set
Unlit	Cancelled

What do you want to do?

To Set / Update	To Cancel
Press  and go to step 3 .	Press  and go to step 5 .
 and go to step 3 .	Go to step 5 .



3 Select setting of the conversion factor.

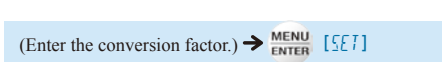

4 Enter the conversion factor.



 "Entering Numerical Values", page 49

 Changing the position of the decimal point
When entering a conversion factor, the position of the decimal point can be changed ( page 50).





Calculation formula for the conversion factor

If we take the conversion factor to be "k" the formula is as follows.

"k" × value in gram units = balance weight reading (user-specified units)

5 Return to the weighing mode.



6 Press to call up the user-specified units.

 "Switching Units", page 41



When user-specified units are called up, no indication of units is given.

Minimum Indication

You can set the minimum weight reading for the user-specified units.

Make the setting by replacing steps **3** and **4** of the conversion factor procedure ( page 84) with the following procedure.

3 Select setting of the minimum indication.



4 Enter the minimum indication.

(Enter the smallest indication.) →  [SET]

 "Entering Numerical Values", page 49



About the minimum weight reading for user-specified units...

This can be set to any required value but in some cases it will not be possible to guarantee the stability of the weight reading display.

8

APPLICATION FUNCTION MODE

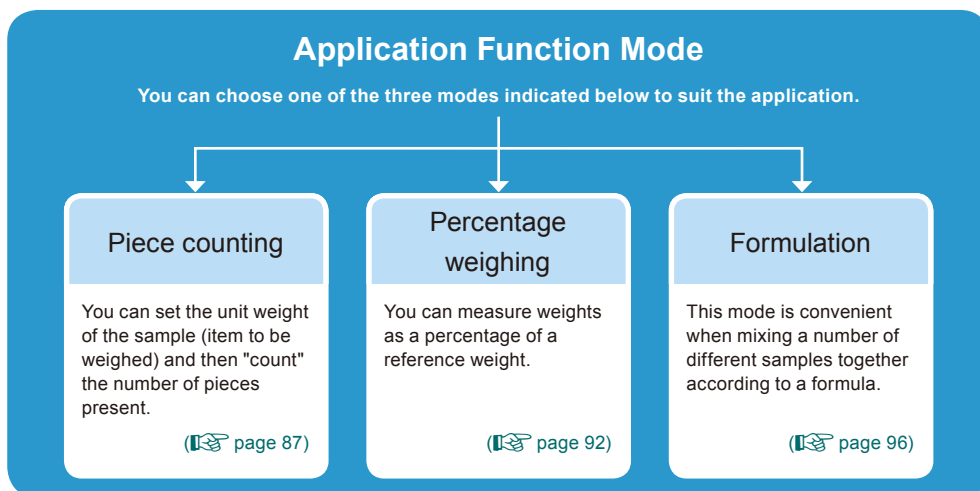

When the application function mode is set...

- ◆ Pressing **FUNC** alternately selects the weighing mode (gram or other unit indication) and the application function mode in use.
- ◆ It can be used in combination with the comparator function (📖 page 102).
- ◆ If the power is turned OFF and back ON the balance will start up in the weighing mode but the application function mode settings will be retained.
- ◆ Pressing **MENU/ENTER** displays the menu for setting the various application function modes. If you then press **UNIT** or **FUNC**, the top hierarchical level of the main menu appears. The flow of the operation for displaying the menu is shown below.

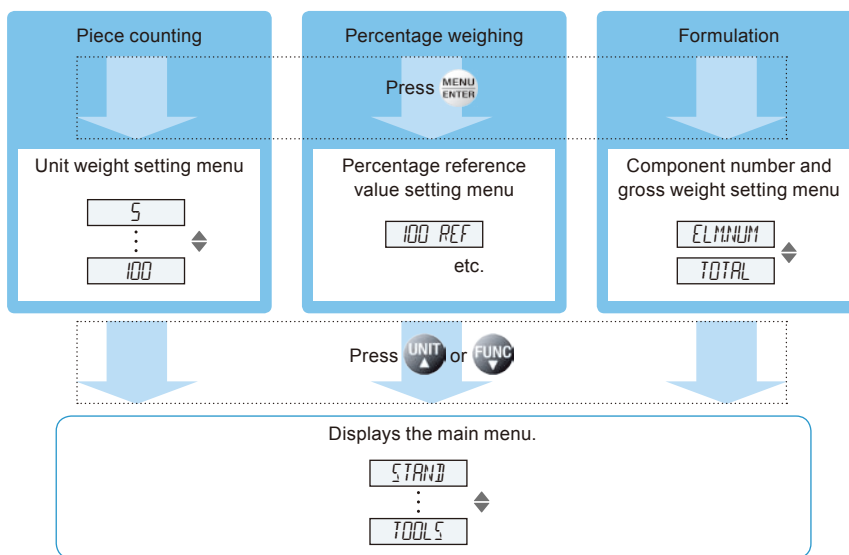

Counting Pieces by Weight (Piece Counting)

You can set the unit weight (weight of a single piece) of the item in advance and then display the number of pieces in the sample.

The unit weight is recorded by placing a sample on the pan that comprises the "number of pieces used for setting".

Unit weights for up to five different types of items can be set at the same time.



Points where care is necessary

- ◆ If the sample is spread out too much or unevenly in the container on the pan, accurate piece counting will not be possible.
- ◆ If a large quantity sample is to be weighed, and the quantity in the sample greatly exceeds the quantity used to set the unit weight, there may be a large counting error.



To minimize the counting error...

- ◆ In step **5** of "Preparation for Piece Counting", make the number of pieces used for setting the unit weight as large as possible.
- ◆ When actually measuring numbers of pieces, don't place a large quantity of the sample on the pan at one time but rather add a small portion at a time and, when the display has stabilized, press **FUNC** for at least 3 seconds to update the unit weight. Keep repeating this operation.

Preparation for Piece Counting (Including Setting the Unit Weight)

The preparations for piece counting are explained here. Only make the setting in the following circumstances.

- You are performing piece counting for the first time.
- You are switching from another application function mode to piece counting.

1 Press **MENU ENTER** in the weighing mode.

This opens the main menu.

2 Select piece counting.

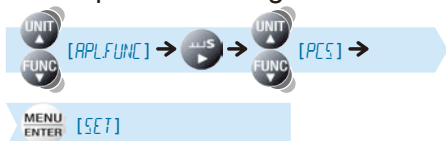

▽ Counting Pieces by Weight (Piece Counting)

3 Select the item number.

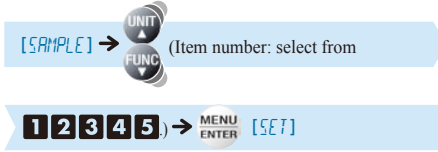

Five different unit weight settings (1 2 3 4 5) can be recorded.



4 Check the number of pieces indication.

The display will indicate whether a unit weight has already been set.

<p>When no unit weight has been set for the item number:</p> <p>[---]</p>	
<p>When a unit weight has already been set for the item number:</p> <p>(The number of pieces is indicated.)</p> <ul style="list-style-type: none"> To update the unit weight, proceed to step 5. If you are not intending to update the unit weight, the procedure from step 5 on is unnecessary. You can start piece counting right away. <p> "Counting Numbers of Pieces", page 90</p>	

5 Select the number of pieces used for setting.

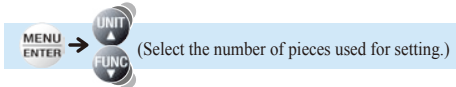

Number of pieces used for setting

The number of pieces used for setting can be selected from among 5 pieces, 10 pieces X pieces.

In order to minimize counting error, make the number of pieces used for setting the unit weight as large as possible.

On pressing UNIT or FUNC ...

A menu option other than the number of pieces for setting may be displayed but this is not abnormal.

Press UNIT or FUNC several times to return to the number of pieces for setting display.

6 Place the container on the pan and press 

The balance will be tared.

7 Put a quantity of the item to be counted corresponding to the selected "number of pieces used for setting" into the container.

8 Check that  (the stability mark) lights up, then confirm.

 [SET]

The unit weight will be set and the number of pieces of the sample will be indicated.

You can now start piece counting.

 "Counting Numbers of Pieces", page 90

If you wish to add the unit weight for another item to be counted, see "Changing a Unit Weight, or Adding a New Unit Weight"

 page 91).



▽ Counting Pieces by Weight (Piece Counting)

■ Counting Numbers of Pieces

1 Enter the piece counting mode

If you have returned to the weighing mode (mode where grams or other units are displayed) from the piece counting mode, then press **FUNC** to enter the counting mode.

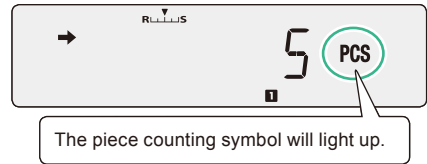

If the piece counting mode is not established...

The preparations for piece counting have not been completed. Make settings according to "Preparation for Piece Counting (Including Setting the Unit Weight)" (👉 page 87).

2 Select the item number.

Each time **UNIT** $\frac{3}{sec}$ is pressed for about three seconds, the selection moves to the next item number and the corresponding item number indication (from **1** to **5**) is displayed.

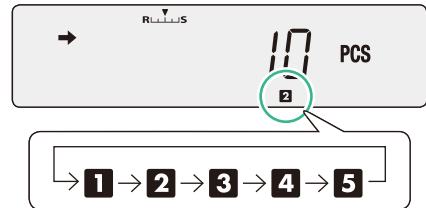

If the display appears as shown to the right...

This means that the unit weight has not been set for the selected item number. To make this setting, follow the procedure in "Changing a Unit Weight, or Adding a New Unit Weight" (👉 page 91).



3 Place a container on the pan and press **→0/T←**

The balance will be tared.

4 Add the sample to be counted into the container.

The number of pieces in the sample is indicated.

The operations of each of the keys after setting are summarized below.

On pressing MENU ENTER ...	Establishes the unit weight setting menu. (👉 step 3 onward on page 91.)
On pressing UNIT ...	Pressing this key alternately displays the set unit weight (in grams) and the number of pieces. Press PRINT while the unit weight is displayed to output the unit weight. While the unit weight is displayed, * (the hold display symbol) is displayed.
On pressing FUNC $\frac{3}{sec}$ for about 3 seconds...	The unit weight is recalculated and updated.
On pressing FUNC ...	The weighing mode is established. Pressing the key once more returns you to the piece counting mode.

■ Changing a Unit Weight, or Adding a New Unit Weight

1 Establish the piece counting mode.

While the weighing mode (mode where grams or other units are displayed) is established, press **FUNC** to switch to the application function mode.



2 Select the item number whose unit weight you want to change, or for which you want to add a unit weight.

Each time you press **UNIT** for about 3 seconds, the next item number is displayed.



"Counting Numbers of Pieces", page 90

3 Press **MENU ENTER**

The number of pieces used for setting will be displayed.



4 Select the number of pieces used for setting.

(Select the number of pieces used for setting.)

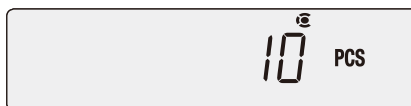

5 Place the container on the pan and press **→O/T←**

The balance will be tared.

6 Put a quantity of the item to be counted corresponding to the selected "number of pieces used for setting" into the container.

7 Check that **→** (the stability mark) lights up, then confirm.

[SET]

The unit weight will be added, and piece counting will become possible.

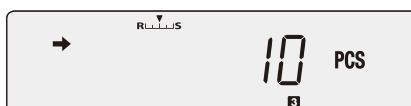

Percentage Weighing

In this mode the weight of the sample is converted to a percentage of the reference weight. The following two setting methods are available for percentage weighing.

100% Reference	The reference weight is set as 100%.
Specific Percentage Reference	The reference weight is set as a percentage value of your choice.

■ Preparation for Percentage Weighing

1 Press  in the weighing mode.
This opens the main menu.

2 Select percentage weighing.

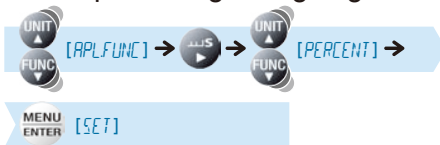

The setting beyond this point differs depending on the percentage value you are assigning to the reference weight.

If the reference weight is being set as 100%, see "When setting the reference as 100%..." (👉 page 93).
If the reference weight is being set as a specific percentage, see "When setting the reference as a percentage of your choice..." (👉 page 94).

When setting the reference as 100%...

3 Select the 100% reference.



(Check the indication.)

The indication differs depending on whether a reference value has already been set or not.

When no percentage reference value has been set

[---



When a percentage reference value has already been set

(The percentage reference value is displayed.)



- To update the percentage reference value, proceed to step 4.
- If you are not updating the percentage reference value, the following steps are not necessary.

"Weighing Percentages", page 95

4 Select 100% reference setting.



5 Place the container on the pan and press

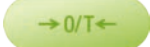

The balance will be tared.

6 Place the sample that is to provide the reference weight in the container.

7 Check that → (the stability mark) lights up, then confirm.



A percentage value with the reference weight taken to be 100% is displayed.
Percentage Weighing is now possible.

"Weighing Percentages", page 95



What to do if...

It is not possible to use a reference weight that weighs less than 100 times the minimum indication of the balance as the reference weight.

BEFORE WEIGHING

USING THE BALANCE

USING MORE CONVENIENTLY

MAINTENANCE

TROUBLESHOOTING

FOR YOUR INFORMATION

▽ Percentage Weighing

When setting the reference as a percentage of your choice...

3 Select the specific percentage reference.



(Check the indication.)

The indication differs depending on whether a reference value has already been set or not.

When no percentage reference value has been set

[---



When a percentage reference value has already been set

(The percentage reference value is displayed.)



- To update the percentage reference value, proceed to step 4.
- If you are not updating the percentage reference value, the following steps are not necessary.

"Weighing Percentages", page 95

4 Enter a percentage value of your choice.

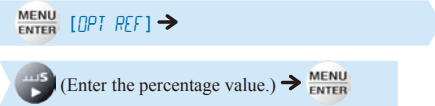

"Entering Numerical Values", page 49



5 Place the container on the pan and press .

The balance will be tared.



6 Place the sample that is to provide the reference weight in the container.

7 Check that (the stability mark) lights up, then confirm.

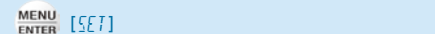

A percentage value calculated by conversion on the basis that the reference weight is equal to the set percentage is displayed.

Percentage weighing is now possible.

"Weighing Percentages", page 95



The specific percentage weighing symbol lights up.



What to do if...

It is not possible to use a reference weight such that the weight corresponding to 100% is less than 100 times the minimum indication of the balance.

■ Weighing Percentages

1 Establish the percentage weighing mode.

If you have returned to the weighing mode (mode where grams or other units are displayed) from the percentage weighing mode, then pressing **FUNC** will take you back to the percentage weighing mode.



The percentage weighing symbol lights up.



If the percentage weighing mode is not established...

The preparations for percentage weighing have not been completed. Make setting in accordance with "Preparation for Percentage Weighing" (page 92).

2 Place the container on the pan and press

The balance will be tared.

3 Insert the sample (item to be measured) into the container.

A percentage value obtained by conversion based on the set reference percentage value and reference weight is displayed.

The operations of each of the keys after setting are summarized below.

On pressing MENU ENTER ...	The percentage reference value setting menu is displayed. (step 4 onward on pages 93 and 94.)
On pressing UNIT ...	The set reference weight (in grams) and the percentage indication are displayed alternately. Press PRINT while the reference weight is displayed to output the reference weight. While the reference weight is displayed, * (the hold display symbol) is displayed.
On pressing UNIT for about 3 seconds...	The 100% reference and specific percentage value are displayed alternately.
On pressing FUNC ...	The mode is switched to the weighing mode. Pressing the key again will return you to the percentage weighing mode.

Formulation

This function is useful when mixing multiple components together by weight, according to a formula. Use this function while the printer is connected to a printer or PC.

The weight of each component is measured and output or added, and on completion of the formulation the gross weight is output.

During formulation the auto zero function (👉 page 72) will not work.

Performing Formulation

1 Press **MENU ENTER** in the weighing mode.

This opens the main menu.

2 Set the balance to the formulation mode.

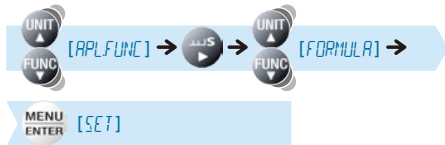

The balance is now ready to weigh. If necessary, set output of the component numbers and output of the gross weight.

👉 "Outputting Component Numbers", page 99

👉 "Outputting the Gross Weight", page 100

3 Place the container on the pan and press **→0/T←**

The balance will be tared.

4 Press **PRINT**

Formulation starts.



The formulation symbol lights up.



The ready symbol lights up, indicating that the balance is ready to weigh.



The ready symbol goes out.

 When the GLP output function ( page 142) is set to ON...
The balance ID ( page 144) and other information is printed.

5 Insert the component into the container.





6 Press  **PRINT**
The weight value of the current sample (item to be weighed: element) is output / recorded and the balance is automatically tared.



The net weight symbol lights up.

Now repeat the operations in steps **5** and **6** to add the other components to the formulation.

7 On completion of formulation, press  ( with the TXB series).

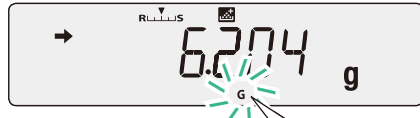





The gross weight symbol flashes.

The total of the individual weight values up to this point (gross weight) is displayed and the balance returns to the ready to weigh status.



The ready symbol lights up, indicating that the balance is ready to weigh.

 To output the gross weight...
Make the setting in "Outputting the Gross Weight" ( page 100) in advance.

 When the GLP output function ( page 142) is set to ON...
The signature panel is printed after the total weight.

▽ Formulation

The operation after setting is as follows.

When in the ready to weigh status:

On pressing  ...

The weighing mode is established.
Pressing the key once more returns you to the ready to weigh status.

When weighing is in progress:

On pressing  ...

The gross weight of the components weighed up to that point is displayed for about 2 seconds.

Example printout from printer
(When the GLP output function is set to ON)

Name of manufacturer	• SHIMADZU CORP.
Balance model name	• TYPE TX323L
Balance serial number	• SN D465412345
Balance ID	• ID 1234

```

-----
CMP001=
      0.900g
CMP002=
      1.280g
CMP003=
      199.610g
TOTAL=
      201.790g
    
```

-SIGNATURE-

The person who carried out measurement signs here.





Outputting Component Numbers

The numbers for each component are automatically assigned to the output results.

- 1 Press  in ready to weigh status while in the formulation mode.

This opens the main menu.



If the ready to weigh status is not established...
Perform steps **1** and **2** of formulation ( page 96).

- 2 Select component number output setting.

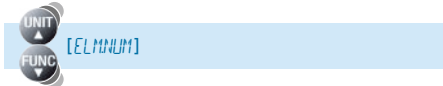

Stability Mark	Outputting Component Numbers
Lit	ON
Unlit	OFF

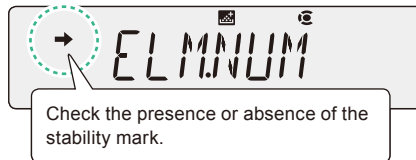

- 3 Change the output setting.

Pressing  alternately sets ON and OFF for the output setting.

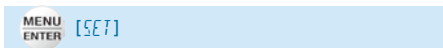

- 4 Return to ready to weigh status.

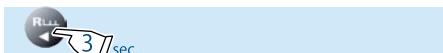

When ON is set the stability mark is lit.

FORMULATION MODE

CMP001=	17.628g
CMP002=	17.628g
CMP003=	17.681g
CMP004=	17.668g
CMP005=	17.659g
TOTAL=	88.264g

Component number

Weight reading for each component (output regardless of the ON/OFF status of component number output)

■ Outputting the Gross Weight

The gross weight for a formulation weighing operation is output at the same time it is displayed. The gross weight is output together with the printed indication: "TOTAL =".

- 1 Press  in ready to weigh status while in the formulation mode.



This opens the main menu.



If the ready to weigh status is not established...

Perform steps **1** and **2** of formulation ( page 96).

- 2 Select gross weight output setting.

  [TOTAL]

Stability Mark	Outputting the Gross Weight
Lit	ON
Unlit	OFF



TOTAL

Check the presence or absence of the stability mark.

- 3 Change the output setting.

Pressing  alternately sets ON and OFF for the output setting.

 [SET]

SET



TOTAL

When ON is set the stability mark is lit.

- 4 Return to ready to weigh status.

 3 sec.

FORMULATION MODE

CMP001= 17.628g

CMP002= 17.628g

CMP003= 17.681g

CMP004= 17.668g

CMP005= 17.659g

TOTAL= 88.264g

~~~~~

Gross weight

BEFORE  
WEIGHING

USING THE  
BALANCE

USING MORE CONVENIENTLY

MAINTENANCE

TROUBLESHOOTING

FOR YOUR  
INFORMATION

MEMO

# 9

# COMPARATOR FUNCTION

The comparator function performs a comparison between the weight reading and a reference value or target value and displays the status of this comparison.

## Comparator Function

You can select and use either of these modes according to the environment of use and application.

### Target mode

After setting a target value and a tolerance range with respect to that target value, excesses and deficits in relation to the target value are indicated by **HI**, **OK** and **LO** (the comparator symbols).

(👉 page 102)

### Checkweighing mode

After setting the threshold values at the upper and lower limits of the pass range, when a sample is weighed a pass or fail determination is indicated by **HI**, **OK** and **LO** (the comparator symbols). An out of range determination is indicated by all comparator symbols OFF.

(👉 page 104)

**Before setting the comparator function**

- ◆ It can be used in combination with the application function mode (👉 page 86).
- ◆ If you are already using the application function mode, read "When the application function mode is set..." (👉 page 86).
- ◆ The comparator function settings are retained even if the power is switched off.

## Target Mode

**1** Press **MENU ENTER** in the weighing mode.  
This opens the main menu.

**2** Select the target mode.

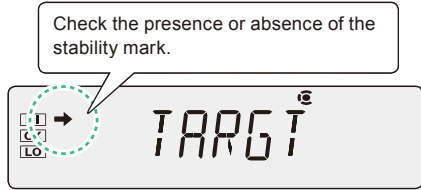

What is the current situation?

| Stability Mark | Target Mode |
|----------------|-------------|
| Lit            | ON          |
| Unlit          | OFF         |

What do you want to do?

| To Set / Update                                   | To Cancel                                         |
|---------------------------------------------------|---------------------------------------------------|
| Press <b>UNIT</b> and go to step <b>3</b> .       | Press <b>MENU ENTER</b> and go to step <b>4</b> . |
| Press <b>MENU ENTER</b> and go to step <b>3</b> . | Go to step <b>4</b> .                             |

### 3 Enter the target value and the tolerance range with respect to the target value.

 "Entering Numerical Values", page 49

When entering the target value:



MENU ENTER (Enter the target value.) → MENU ENTER [SET]



When entering the tolerance range with respect to the target value:



MENU ENTER (Enter the tolerance range value.) → MENU ENTER [SET]



### 4 Return to the weighing mode.



### 5 Place the container on the pan and press

The balance will be tared.

### 6 Insert a sample into the container.

Excess or deficiency is determined according to the the following conditions.

The comparator symbols light in accordance with the excess/deficiency judgment.



| Condition                                                        | Judgment                                          | Comparator Symbol           |
|------------------------------------------------------------------|---------------------------------------------------|-----------------------------|
| Over the target value range                                      | Large difference with respect to the target value | <b>HI</b> (flashes slowly)  |
|                                                                  | Small difference with respect to the target value | <b>HI</b> (flashes quickly) |
| Within the target value range (target value ± permissible range) | Acceptable                                        | <b>OK</b>                   |
| Under the target value range                                     | Small difference with respect to the target value | <b>LO</b> (flashes quickly) |
|                                                                  | Large difference with respect to the target value | <b>LO</b> (flashes slowly)  |

# Checkweighing Mode

**1** Press **MENU ENTER** in the weighing mode.

This opens the main menu.

**2** Select the checkweighing mode.

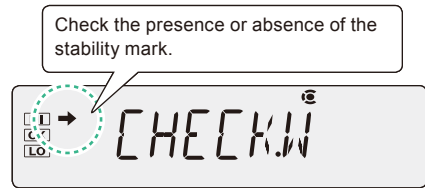
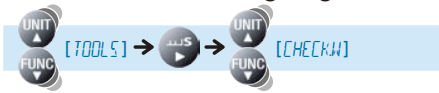

What is the current situation?

| Stability Mark | Checkweighing Mode |
|----------------|--------------------|
| Lit            | ON                 |
| Unlit          | OFF                |

What do you want to do?

| To Set / Update                                   | To Cancel                                         |
|---------------------------------------------------|---------------------------------------------------|
| Press <b>RIGHT</b> and go to step <b>3</b> .      | Press <b>MENU ENTER</b> and go to step <b>4</b> . |
| Press <b>MENU ENTER</b> and go to step <b>3</b> . | Go to step <b>4</b> .                             |

**3** Enter the pass range upper limit value and lower limit value, and the checkweighing range lower limit value and checkweighing range upper limit value.

"Entering Numerical Values", page 49

To enter the pass range upper limit value:

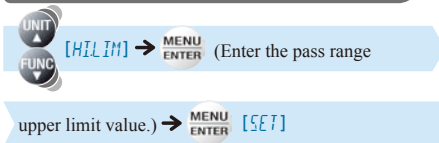

To enter the pass range lower limit value:

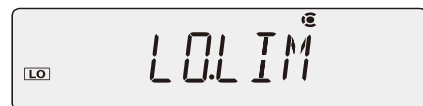
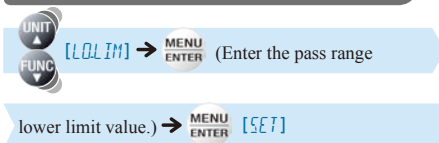



To enter the checkweighing range lower limit value:



lower limit value.) → MENU/ENTER [SET]



To enter the checkweighing range upper limit value:

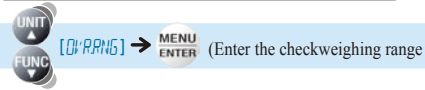

upper limit value.) → MENU/ENTER [SET]



**Be sure to double check all values.**

If the entered values don't go together logically, for example if a value lower than the lower limit value is entered as the upper limit value, the values will be automatically corrected and other values will be set.

Particular care is required when entering new values where settings have been made before (updating).

#### 4 Return to the weighing mode.

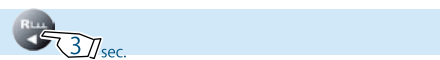

#### 5 Place the container on the pan and press →0/T←

The balance will be tared

#### 6 Insert the sample (item to be measured) into the container.

Pass or fail determination is based on the following conditions.

The comparator symbols light in accordance with the pass or fail determination.



| Condition                                                                                       | Result       | Comparator Symbol |
|-------------------------------------------------------------------------------------------------|--------------|-------------------|
| Upper limit value of the checkweighing range < indication                                       | Out of Range | All off           |
| Upper limit value of the pass range < indication ≤ upper limit value of the checkweighing range | HI           | <b>HI</b>         |
| Lower limit value of the pass range ≤ indication ≤ upper limit value of the pass range          | PASS         | <b>OK</b>         |
| Lower limit value of the checkweighing range ≤ indication < lower limit value of the pass range | LO           | <b>LO</b>         |
| indication < lower limit value of the checkweighing range                                       | Out of Range | All off           |

With TW/TX/TXB series balances, weight readings, settings and other data can be output to a personal computer or a printer.

This section describes some convenient functions relating to output, and how to connect the balance to a PC or printer (option).

## Convenient Functions Relating to Output

### Printing / Outputting Automatically (Auto Print Function)

This function allows you to automatically output the displayed weight reading at each weighing without pressing .

Select the output timing from among the following five modes.

|                            | Stable Positive Value | Stable Negative Value | Stable Zero Indication | Pass in Checkweighing Mode | Explanation                                                                                                                                                                                                                                                  |
|----------------------------|-----------------------|-----------------------|------------------------|----------------------------|--------------------------------------------------------------------------------------------------------------------------------------------------------------------------------------------------------------------------------------------------------------|
| Mode 1<br><i>L 11 .</i>    | ○                     |                       |                        |                            | When stability is detected with a positive value, the value is output.                                                                                                                                                                                       |
| Mode 2<br><i>L 11.11.</i>  | ○                     | ○                     |                        |                            | When stability is detected with a positive or negative value, the value is output.                                                                                                                                                                           |
| Mode 3<br><i>L 11 .Z</i>   | ○                     |                       | ○                      |                            | When stability is detected with a positive value, or when the reading has returned to zero, the value is output.                                                                                                                                             |
| Mode 4<br><i>L 11.11.Z</i> | ○                     | ○                     | ○                      |                            | When stability is detected with a positive or negative value or when the reading has returned to zero, the value is output.                                                                                                                                  |
| Mode 5<br><i>L 11.0K.</i>  |                       |                       |                        | ○                          | When the auto print function is used in combination with the checkweighing mode (  page 104) and stability is detected with an "OK" determination, the value is output. |

○ : Output, Blank: Not output

- 1 Press  for about 3 seconds in the weighing mode.

This opens the output menu.

## 2 Select the auto print function.

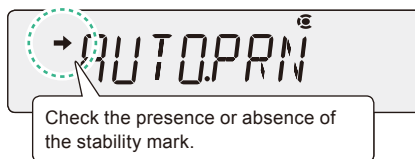
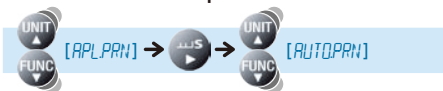

What is the current situation?

| Stability Mark | Auto Print Function |
|----------------|---------------------|
| Lit            | ON                  |
| Unlit          | OFF                 |

What do you want to do?

| To Set / Update          | To Cancel                |
|--------------------------|--------------------------|
| Press  and go to step 3. | Press  and go to step 5. |
| Press  and go to step 3. | Go to step 5.            |

## 3 Select the mode for output timing.

Select the output timing from among mode 1 to mode 5 (see the table on the previous page).



As an example, assume here that mode 3 is selected (output with a stable positive value or a stable zero indication).

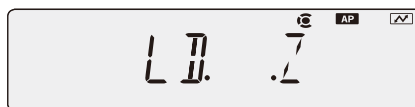

## 4 If necessary, set zero return requirement.



[RET. 50] → [SET]



- When "RET. 0" is set:



### ? What is zero return requirement?

After the previous sample (item to be weighed) has been removed from the pan, the weight reading must fall below the zero value and stability must be achieved before the next sample is placed on the pan, otherwise there will be no automatic output for this next sample. This function is intended to prevent two or more outputs being made for the same sample. For the zero return value, select either zero or 50% of the weight of the immediately preceding sample. Setting 50% saves time because even if the display doesn't return to zero, as long as stability is achieved, output will be possible if the next sample is placed on the pan.

If you are not setting zero return requirement, proceed to step 5.

## ▽ Convenient Functions Relating to Output

### 5 Return to the weighing mode.

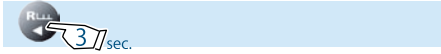

When the setting is made, the auto print symbol lights up.

### 6 Place the container on the pan and press

The balance will be tared.

### 7 Place the sample into the container.

After  (the stability mark) lights up, the displayed weight reading is automatically output.

### 8 Remove the sample from the pan.

If  (the stability mark) lights up at a value close to zero, the displayed weight reading is automatically output.

## ■ Printing / Outputting Continuously (Continuous Output Function)

This function allows displayed weight readings to be automatically output continuously in the same timing as the display refresh cycle (approximately 100 msec intervals) while weighing, without having to press 

### 1 Press for about 3 seconds in the weighing mode.

### 2 Select the continuous output function.



Check the presence or absence of the stability mark.

| Stability Mark | Continuous Output Function |
|----------------|----------------------------|
| Lit            | ON                         |
| Unlit          | OFF                        |

### 3 Change the setting.

Pressing  alternately sets the ON and OFF settings.

 [SET]

If OFF is selected, perform step **6**. Steps **7** onward are not necessary in this case.

SET 

 SEQ.PRN 

When ON is set the stability mark is lit.

MANU 

### 4 Set whether starting and ending of the continuous output is performed manually by key operation.

  [MANU]

Pressing  alternately sets the ON and OFF settings.

 [SET]

SET 

 MANU 

When ON is set the stability mark is lit.

NO.FIL 

### 5 Set whether the non-averaged value is output as a continuous output value.

[MANU]   [NO.FIL]

Pressing  alternately sets the ON and OFF settings.

 [SET]

SET 

 NO.FIL 

When ON is set the stability mark is lit.

## ▽ Convenient Functions Relating to Output

### 6 Return to the weighing mode.

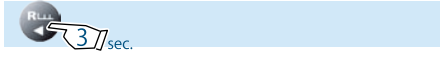

When OFF is set for "MANU" in step 4, continuous output starts.

Step 8 is not necessary in this case.



When ON is set for "MANU" in step 4, the ready symbol lights up.

### 7 Place the container on the pan and press

The balance will be tared.

### 8 Press (when ON is set for "MANU" in step 4).

After **READY** (the ready symbol) has gone off, displayed weight readings are continuously output.

### 9 Place the sample in the container.

Displayed weight readings will be automatically output in the same timing as the display refresh cycle (approximately 100 msec intervals).





#### Pausing and restarting the continuous output function

To pause the function, press  ( with the TXB series).

To restart it, press 



#### When OFF is set for "MANU" in step 4...

"MANU" is set to ON when  ( with the TXB series) is pressed and the continuous output function is temporarily stopped.



#### Operation of (the communication symbol)

During continuous output, it may appear as though  (the communication symbol) is continuously lit.

Note also that if the transmission speed for data output is slow the display will be unstable and the response time of the balance will also be slow.



#### When connected to a printer...

For reasons linked to the performance of the printer, the data output interval will increase to longer than 100 msec.

# WindowsDirect Communication Function

## What Is the WindowsDirect Communication Function?

In any Windows application (e.g. Excel or the weight input window of an analytical device), the numerical value displayed at the balance can be transferred to the cursor position just as if it had been entered from the keyboard. The main body of the balance has a keyboard function, so communication software is not required. As long as the status allows key entry, data can be directly sent to the target device.



### What to do if...

- ◆ After installing communications software in the PC and attempting communications, it is not possible to use the WindowsDirect communication function even though the OS is Windows. Refer to communications setting as described in "User-Specified Settings" (page 126).
- ◆ To control the balance from a PC, you must use command codes for programming (page 120), not the WindowsDirect function.
- ◆ A dedicated tool is required in order to run the WindowsDirect communication function with Windows Vista. For details, contact your Shimadzu representative.

## Setting the Function

- ◆ Making the settings at the balance

When this setting is made, all of the communications settings are changed to those appropriate for WindowsDirect communication. See "Communication Settings" (page 125).

- 1 Press  for about 3 seconds in the weighing mode.

This opens the output menu.

- 2 Select WindowsDirect communication.



- When "WIN|" has been selected:



When  (the stability mark) is lit up...

The output data format has already been set. If you proceed to the next step in this status the setting will be cancelled and the balance will return to the status immediately before setting.

## ▽ WindowsDirect Communication Function

There are four types of output data format.

| Indication | Output Data Format                     |
|------------|----------------------------------------|
| WIN        | Numerical value + [ENTER]              |
| WIN-U      | Numerical value, unit symbol + [ENTER] |
| WIN-       | Numerical value + [Tab]                |
| WIN-U      | Numerical value, unit symbol + [Tab]   |



If you have selected a format with [ENTER] appended...

In some Windows applications, ENTER may cause the current window to close. If this is the case, select a format with [Tab] appended.

### 3 Confirm and return to the weighing mode.



This completes the setting procedure at the balance.

When the function is set, **WIN** (the Win symbol) lights up.



#### ◆ Connecting the RS-232C cable

### 1 Press () with the TXB series) in the weighing mode.

With a TW/TX series balance, **READY** (the ready symbol) will light up and the standby mode will be established.

With a TXB series balance, the power will be shut off.

### 2 Remove the AC adapter from the power outlet.

### 3 Connect the RS-232C cable to the RS-232C connector on the rear of the balance.

### 4 Connect the RS-232C cable to the PC.

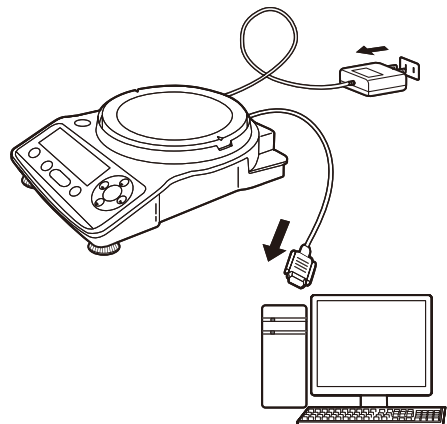



◆ Making the settings at the PC

As an example, the settings made with Windows XP are explained here.

**1** Turn on the power to the PC

**2** Click [start] (→ [Settings]) → [Control Panel].

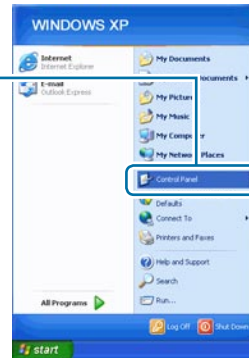

**3** Click [Accessibility Options] in the Control Panel.

The [Accessibility Options] screen will be displayed.

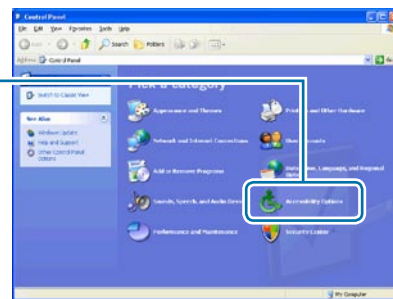

**4** Enter a check mark at [Use Serial Keys] under the [General] tab.



In addition...

- ◆ If you find [Administrative options] under the [General] tab too, enter a check mark here as well as at [Use Serial Keys].
- ◆ Remove all check marks from all checkboxes under tabs other than the [General] tab.

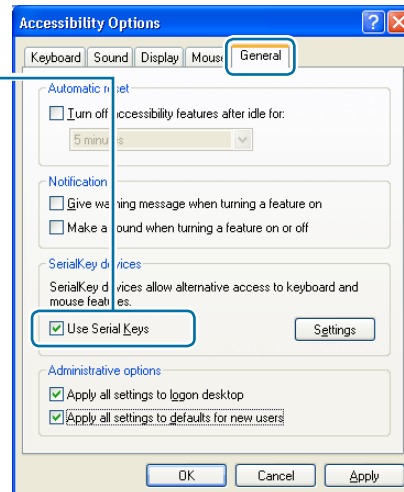

## 5 Clicks [Settings].

The [Settings for SerialKeys] dialog box will be displayed.

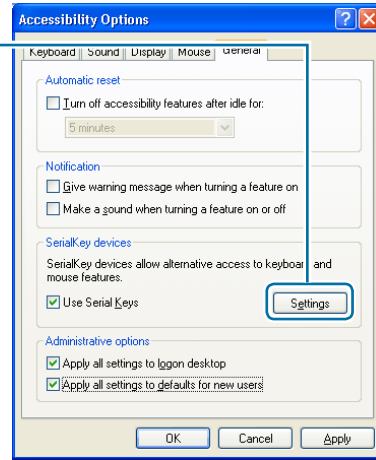

## 6 Select the serial port to be used for the connection with the balance and set the baud rate to "300".

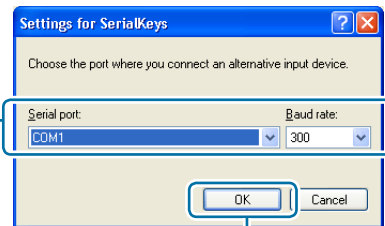

## 7 Click [OK].

Return to the [Accessibility Options] window.

## 8 Click [Apply].

Wait a short time until the [Apply] character color fades.

## 9 Click [OK].

This completes the settings at the PC.

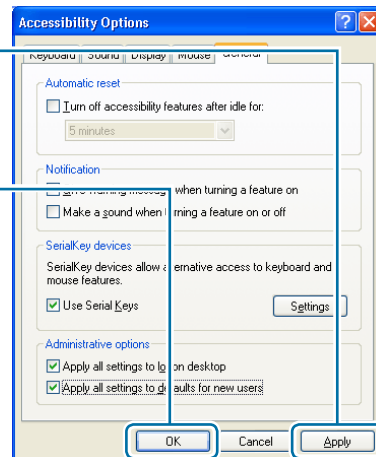

### When the RS-232C port is used for another purpose...



Once a serial key device has been activated, other software that uses the same RS-232C port will not operate normally. If a device such as an external modem or a plotter is connected to the same RS-232C port, after connecting the balance you must remove the check mark from the [Use Serial Keys] checkbox to invalidate serial key devices.

◆ Checking operation

- 1** Connect the AC adapter to the power outlet (with the TXB series, press ).

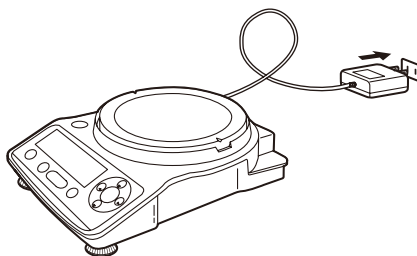
The balance's self check display ( page 31) will be shown.



- 2** When [OFF] is displayed, press  ( with the TXB series) to enter the weighing mode.

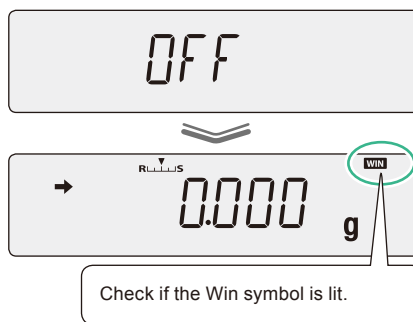

- 3** At the PC, start up Excel (or another application such as Notepad).

Key entry will be enabled and the cursor will be displayed at the position where entry is possible.

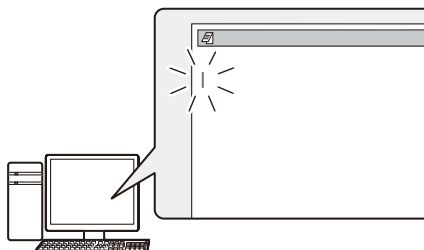

- 4** Press  on the balance.

The numerical value displayed on the balance will be transferred to the cursor position.

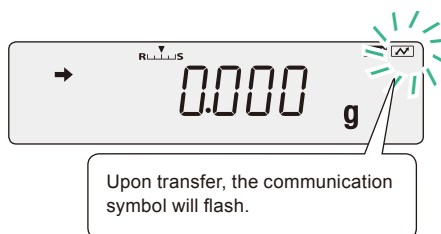

When the auto print function is used together with the WindowsDirect communication function...

Check that operation is normal even when using the auto print function.

 "Printing / Outputting Automatically (Auto Print Function)", page 106

## Troubleshooting the WindowsDirect Communication Function

If the WindowsDirect communication function doesn't run properly, check the following points. If this doesn't resolve the problem, contact your Shimadzu representative.

|           |                                                                                                                                                                                                                                                                                                                                                                                                                                                                                                                                                                                                                                                                                                                                                                                                                                                                                                                                                                                                                                                                                                                                                 |
|-----------|-------------------------------------------------------------------------------------------------------------------------------------------------------------------------------------------------------------------------------------------------------------------------------------------------------------------------------------------------------------------------------------------------------------------------------------------------------------------------------------------------------------------------------------------------------------------------------------------------------------------------------------------------------------------------------------------------------------------------------------------------------------------------------------------------------------------------------------------------------------------------------------------------------------------------------------------------------------------------------------------------------------------------------------------------------------------------------------------------------------------------------------------------|
| <b>Q1</b> | <b>WindowsDirect communication has been set but it is not operating at all.</b>                                                                                                                                                                                                                                                                                                                                                                                                                                                                                                                                                                                                                                                                                                                                                                                                                                                                                                                                                                                                                                                                 |
| A1        | <ul style="list-style-type: none"> <li>● Check the type of communications cable used for the connection (Shimadzu authorized part or another part available on the general market) and the soundness of the connection.</li> <li>● If a USB serial converter is used, depending on the circumstances at the setup there is a possibility that it has been automatically set to a COM port number higher than 4, and in this case you should reassign it to a COM port number that can be used by serial key devices (COM1 to COM4).</li> <li>● It is possible that the driver used as an accessory with the USB serial converter has not been set up properly. Try uninstalling the driver and installing it again.</li> <li>● Some notebook PCs feature a setting for disabling RS-232C ports as a power-saving measure. Before trying to use the WindowsDirect communication function, make the setting that enables the use of RS-232C ports.</li> <li>● Communications with other applications and PCs via a LAN may interfere with the serial key device settings. Try using WindowsDirect communication without using the LAN.</li> </ul> |
| <b>Q2</b> | <b>The WindowsDirect communication function won't work after I restart the PC.</b>                                                                                                                                                                                                                                                                                                                                                                                                                                                                                                                                                                                                                                                                                                                                                                                                                                                                                                                                                                                                                                                              |
| A2        | <ul style="list-style-type: none"> <li>● Some PCs don't recognize that a serial key device has been set when they start up. For details on how to deal with this, contact your Shimadzu representative.</li> </ul>                                                                                                                                                                                                                                                                                                                                                                                                                                                                                                                                                                                                                                                                                                                                                                                                                                                                                                                              |
| <b>Q3</b> | <b>I want to use the WindowsDirect communication function with Windows Vista.</b>                                                                                                                                                                                                                                                                                                                                                                                                                                                                                                                                                                                                                                                                                                                                                                                                                                                                                                                                                                                                                                                               |
| A3        | <ul style="list-style-type: none"> <li>● Windows Vista doesn't have the serial device setting screen that is required to set the WindowsDirect communication function. For details on the setting, contact your Shimadzu representative.</li> </ul>                                                                                                                                                                                                                                                                                                                                                                                                                                                                                                                                                                                                                                                                                                                                                                                                                                                                                             |
| <b>Q4</b> | <b>Data is input to the PC as garbled characters.</b>                                                                                                                                                                                                                                                                                                                                                                                                                                                                                                                                                                                                                                                                                                                                                                                                                                                                                                                                                                                                                                                                                           |
| A4        | <ul style="list-style-type: none"> <li>● Either the balance or the PC is not set for the WindowsDirect connection function. Make the settings again by referring to "Setting the Function" (📖 page 111).</li> </ul>                                                                                                                                                                                                                                                                                                                                                                                                                                                                                                                                                                                                                                                                                                                                                                                                                                                                                                                             |
| <b>Q5</b> | <b>When data is input into Excel, the cursor doesn't move to another cell.</b>                                                                                                                                                                                                                                                                                                                                                                                                                                                                                                                                                                                                                                                                                                                                                                                                                                                                                                                                                                                                                                                                  |
| A5        | <ul style="list-style-type: none"> <li>● If a function for conversion to 2-byte characters is available in Windows, turn the setting for this function off.</li> <li>● Click the [Edit] tab under [Options] in Excel and check [Move selection after Enter] (if cells move in response to keyboard input there is no problem).</li> <li>● Check the input data in another application (e.g. Notepad).</li> </ul>                                                                                                                                                                                                                                                                                                                                                                                                                                                                                                                                                                                                                                                                                                                                |
| <b>Q6</b> | <b>The operation is sometimes abnormal.</b>                                                                                                                                                                                                                                                                                                                                                                                                                                                                                                                                                                                                                                                                                                                                                                                                                                                                                                                                                                                                                                                                                                     |
| A6        | <ul style="list-style-type: none"> <li>● Depending on the processing capability of the PC, malfunctions may occur if the communications speed is high. Set 300 bps for the communication speed. Malfunctions may also occur if the interval for data transmission from the balance is too short. Ensure that one batch of data is displayed on the screen before the next batch of data is sent. And if there is limited processing capability, don't use the continuous output function.</li> <li>● When data is sent from the balance, don't touch the PC's keyboard or mouse.</li> </ul>                                                                                                                                                                                                                                                                                                                                                                                                                                                                                                                                                     |

## Connecting to a PC (RS-232C)

### Caution



Instructions

Use a correctly connected cable.

The connection method and special accessory RS-232C cable described below do not guarantee normal operation with all types of PC.

When using the WindowsDirect communication function, see "WindowsDirect Communication Function" ( page 111).

### Cable Connection Method

- ◆ For IBM PC/AT, DOS/V, and AX PC (D-sub 9-pin) (Straight connection)

| PC Side |   |       | Balance Side |     |
|---------|---|-------|--------------|-----|
| RXD     | 2 | ————— | 2            | TXD |
| TXD     | 3 | ————— | 3            | RXD |
| DTR     | 4 | ————— | 4            | DSR |
| SG      | 5 | ————— | 5            | SG  |
| DSR     | 6 | ————— | 6            | DTR |
| RTS     | 7 | ┌───┐ | 7            | CTS |
| CTS     | 8 | └───┘ | 8            | RTS |
| NC      | 9 |       | 9            |     |

BEFORE  
WEIGHING

USING THE  
BALANCE

USING MORE CONVENIENTLY

MAINTENANCE

TROUBLESHOOTING

FOR YOUR  
INFORMATION

▽ Connecting to a PC (RS-232C)

## Data Format

The details of the data format when standard setting 1 (*MODE.1*) or data format 2 (*DF.2*) in the user settings has been selected in the communication settings (🔗 page 125) are given below.

### ◆ Standard format

The data format when outputting negative values (for example: -123.456 g) is as shown below. The delimiter is a carriage return.

The data length varies depending on the accompanying information, the number of characters used to indicate units, the delimiter and so on.

Data length for this example: 12 bytes

|            |     |     |     |     |     |     |     |     |     |     |     |     |
|------------|-----|-----|-----|-----|-----|-----|-----|-----|-----|-----|-----|-----|
|            | ①   | ②   |     |     |     |     |     |     |     | ③   |     | ④   |
| Position   | 1   | 2   | 3   | 4   | 5   | 6   | 7   | 8   | 9   | 10  | 11  | 12  |
| ASCII code | 2DH | 20H | 31H | 32H | 33H | 2EH | 34H | 35H | 36H | 67H | 20H | 0DH |
| Data       | -   |     | 1   | 2   | 3   | .   | 4   | 5   | 6   | g   |     | C/R |

| No. | Position                           | Explanation                                                                                                                                                                                      |
|-----|------------------------------------|--------------------------------------------------------------------------------------------------------------------------------------------------------------------------------------------------|
| ①   | Position 1 (sign)                  | If the value is positive " " (a space) is entered and if the value is negative "-" (a minus symbol) is entered.                                                                                  |
| ②   | Positions 2 to 9 (absolute values) | If not all of the eight locations are used for a numerical value, a code representing a space is entered at the blank positions, as shown in the example.                                        |
| ③   | Positions 10 and 11 (units)        | If the unit designation comprises one character, a code representing a space is entered at position 11.<br>If the unit designation comprises three characters, a total of 13 characters is sent. |
| ④   | Position 12 (delimiter)            | This is a code that represents the delimiter.                                                                                                                                                    |

◆ When the data length is longer than the standard

When outputting data with stability information included

A code representing S or U is appended at the head of the data.

Accordingly, the data length is increased by one byte.

|            |     |     |     |     |
|------------|-----|-----|-----|-----|
| Position   | 1   | 2   | 3   | 4   |
| ASCII code | 53H | 2DH | 20H | 31H |
| Data       | S   | -   |     | 1   |

When stable: S (53H)  
When unstable: U (55H)

When the delimiter "C/R+L/F" is selected

Two bytes are required for the delimiter information.

One byte is added after position 12 in the standard format. Accordingly, the data length is increased by one byte.

|            |     |     |     |     |
|------------|-----|-----|-----|-----|
| Position   | 1   | 11  | 12  | 13  |
| ASCII code | 2DH | 20H | 0DH | 0AH |
| Data       | -   |     | C/R | L/F |

◆ When there is "OL" or "-OL" (overload) output

The data format when "OL" is included is shown below.

Data length for this example: 12 bytes

|            |     |     |     |     |     |     |     |     |     |     |     |     |
|------------|-----|-----|-----|-----|-----|-----|-----|-----|-----|-----|-----|-----|
| Position   | 1   | 2   | 3   | 4   | 5   | 6   | 7   | 8   | 9   | 10  | 11  | 12  |
| ASCII code | 20H | 20H | 20H | 20H | 20H | 4FH | 4CH | 20H | 20H | 20H | 20H | 0DH |
| Data       |     |     |     |     |     | O   | L   |     |     |     |     | C/R |

When the information is "-OL" (minus overload), the entry at position 1 is changed from a space to "-" (a minus symbol, ASCII code 2DH).

## ▽ Connecting to a PC (RS-232C)

### ■ Command Codes

- ◆ Commands whose final character is a numeral, a letter of the alphabet, or a symbol other than "="

Each command code is sent to the balance with a delimiter appended at the end

Example 1:

|                     |                                                                                                                |
|---------------------|----------------------------------------------------------------------------------------------------------------|
| P R I N T ( C / R ) | This is the same as pressing  |
|---------------------|----------------------------------------------------------------------------------------------------------------|

- ◆ Commands whose final character is "="

Each command code is sent to the balance followed by numerals (sometimes including a decimal point) and with a delimiter appended at the end.

Example 2:

|                        |                                     |
|------------------------|-------------------------------------|
| ID = 1 2 3 4 ( C / R ) | This sets "1234" as the balance ID. |
|------------------------|-------------------------------------|

Example 3:

|                                                                                         |                                                           |
|-----------------------------------------------------------------------------------------|-----------------------------------------------------------|
| UW1 = 1 . 2 3 ( C / R )<br>(Example for models with two places after the decimal point) | This sets 1.23 g as the unit weight for piece counting 1. |
|-----------------------------------------------------------------------------------------|-----------------------------------------------------------|

Example 4:

|                                                                                         |                                                   |
|-----------------------------------------------------------------------------------------|---------------------------------------------------|
| UW1 = 0 . 0 0 ( C / R )<br>(Example for models with two places after the decimal point) | This clears the unit weight for piece counting 1. |
|-----------------------------------------------------------------------------------------|---------------------------------------------------|

Working from the PC connected to the balance, it is possible to instruct a weighing operation or to display a numerical value of your choice at the balance.

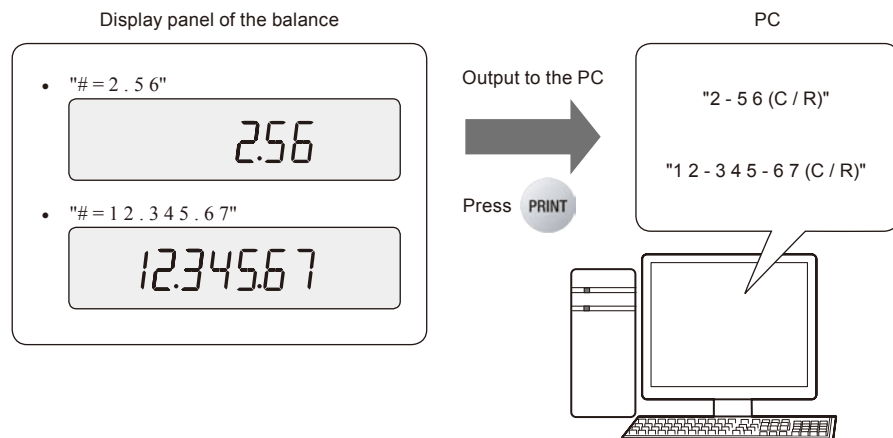

 **Output to the PC**

In order to distinguish between instruction information from the PC and the balance's weight display data, "." is converted to "-" before output.



### ◆ Echo-back commands

A character string comprising N characters following an echo-back command "{" or "}" and terminated by a delimiter is resent unchanged from the balance (provided unprocessed commands do not remain in the balance's receive buffer, and  $N \leq 30$ ).

Example 5:

|                                    |                                                                                                                                                                                                                                              |
|------------------------------------|----------------------------------------------------------------------------------------------------------------------------------------------------------------------------------------------------------------------------------------------|
| A B C D E F G 1 2 3 4 5<br>(C / R) | After receiving this command, the balance outputs A B C D E F G 1 2 3 4 5 (C/R).<br>When a printer is used in combination with the balance, this character string can be printed by the printer (printing of any required character string). |
|------------------------------------|----------------------------------------------------------------------------------------------------------------------------------------------------------------------------------------------------------------------------------------------|



#### To print with the printer

Only use upper case letters of the alphabet, numerals and some symbols (including the decimal point and signs), and limit the string to within 15 characters.

### ◆ Command list

#### Data output

| Command | Function                                     |
|---------|----------------------------------------------|
| D01     | Continuous output                            |
| D02     | Continuous output at stability               |
| D03     | Continuous output with stability information |
| D04     | Forced single output                         |
| D05     | Single output                                |
| D06     | Auto print setting                           |
| D07     | Single output with stability information     |
| D08     | Single output at stability                   |
| D09     | Cancel output                                |

#### Key operation

| Command | Function                  |
|---------|---------------------------|
| BREAK   | Break key                 |
| Q       |                           |
| CAL     | Calibration key           |
| TARE    | Zero setting / taring key |
| T       |                           |
| PRINT   | Output key                |



#### Acceptance of commands

Depending on the status of the balance, even though a command is output it may not be accepted, with the display of "COM ERR".

▽ Connecting to a PC (RS-232C)

### Application weighing

| Command                    | Function                                       |                                        |
|----------------------------|------------------------------------------------|----------------------------------------|
| R                          | Cancels application weighing mode setting      |                                        |
| <b>Piece counting</b>      |                                                |                                        |
| PCS□                       | Sets the piece counting (PCS) mode             | □: 1 to 5 mode numbers                 |
| UW□ = XX.XXX               | Sets the unit weight                           | XX.XXX : Setting value                 |
| UW□                        | Reads the unit weight*                         |                                        |
| UB□ = XXX                  | Sets the reference number of pieces            | XXX : Reference number of pieces value |
| UB□                        | Reads the reference number of pieces           |                                        |
| RECAL                      | Recalculates the unit weight                   |                                        |
| <b>Percentage weighing</b> |                                                |                                        |
| G                          | Switches between percentage (%) and gram units |                                        |
| %I                         | Sets the percentage weighing mode              | "%" can also be used.                  |
| <b>Formulation</b>         |                                                |                                        |
| M                          | Sets the formulation mode                      |                                        |

\* With the TWC\*\*3L and TXC\*\*3L, gram units are displayed in 0.0002 g intervals.  
 When a value that the balance cannot display has been set with command UW□, however, the value set with the command is used for calculations.

### Other functions

| Command           | Function                                                                                                                                                                     |                      |
|-------------------|------------------------------------------------------------------------------------------------------------------------------------------------------------------------------|----------------------|
| <b>Comparator</b> |                                                                                                                                                                              |                      |
| TRGT              | Establishes the target mode                                                                                                                                                  |                      |
| TARGET = XX.XX    | Sets the target in the target mode                                                                                                                                           | XX.XX: Setting value |
| LIMIT = XX.XX     | Sets the target range in the target mode                                                                                                                                     |                      |
| CHKW              | Establishes the checkweighing mode                                                                                                                                           |                      |
| OVR.RNG = XX.XX   | Sets the checkweighing range upper limit value in the checkweighing mode                                                                                                     | XX.XX: Setting value |
| UND.RNG = XX.XX   | Sets the checkweighing range lower limit value in the checkweighing mode                                                                                                     |                      |
| HI.LIM = XX.XX    | Sets the pass range upper limit value in the checkweighing mode                                                                                                              |                      |
| LO.LIM = XX.XX    | Sets the pass range lower limit value in the checkweighing mode                                                                                                              |                      |
| GO                | Reads the results<br>[Response command]<br>HL (above "too heavy" range)<br>HI (too heavy)<br>OK (appropriate weight, pass)<br>LO (too light)<br>LL (below "too light" range) |                      |

### System-related commands

| Command   | Function                    |                     |
|-----------|-----------------------------|---------------------|
| ID = XXXX | Sets the balance ID         | XXXX: Setting value |
| ID        | Reads the balance ID        |                     |
| STATE     | Outputs the setting details |                     |

## Commands relating to calibration

| Command          | Function                                                |                        |
|------------------|---------------------------------------------------------|------------------------|
| ECAL             | Starts external calibration                             |                        |
| ECAL.W = XXX.XXX | Sets the reference weight value (W ref) for calibration | XXX.XXX: Setting value |
| ETEST            | Starts an external calibration check                    |                        |
| ICAL             | Executes calibration with the internal weight           |                        |
| ITEST            | Executes a calibration check with the internal weight   |                        |

## Commands relating to zero / taring

| Command      | Function            |                      |
|--------------|---------------------|----------------------|
| ZRNG = X.XXX | Sets the zero range | X.XXX: Setting value |

## Commands relating to unit registration

| Command        | Function                                                                     |                                |
|----------------|------------------------------------------------------------------------------|--------------------------------|
| g              | Sets gram units                                                              |                                |
| mg             | Sets milligram units (only accepted by models capable of displaying 0.001 g) |                                |
| kg             | Sets kilogram units                                                          |                                |
| ct             | Sets carat units                                                             |                                |
| mom            | Sets momme units                                                             |                                |
| CU□            | Sets / cancels user-specified units                                          | □ 0: Cancel, 1: Set            |
| UCOFF = X.XXXX | Sets the conversion factor for user-specified units                          | X.XXXX: Setting value          |
| UDIG = X.XXX   | Sets the minimum displayed value for user-specified unit conversion          | X.XXX: Minimum displayed value |

## Other companies' commands

| Command | Function                                       |
|---------|------------------------------------------------|
| TI      | Immediate taring (Mettler)                     |
| S       | Single output at stability (Mettler)           |
| SI      | Immediate single output (Mettler)              |
| SIR     | Continuous output (Mettler)                    |
| SR      | Continuous output at stability (Mettler)       |
| (ESC) P | Immediate single output (Sartorius) ESC = &H1B |
| (ESC) T | Immediate taring (Sartorius) ESC = &H1B        |

## Others

| Command      | Function                              |                            |
|--------------|---------------------------------------|----------------------------|
| "_" (space)  | Buffer clear command                  |                            |
| # = XXXXXXXX | Enters and displays a numerical value | XXXXXXXX : Numerical value |
| {□□ ...      | Echo-back mode                        | □□ ...: Character string   |

## Connecting to a Printer

TW/TX/TXB series balances can be connected to the following electronic printers (available as options).

- EP-80 electronic printer
- EP-90 electronic printer



Outputting to a printer while simultaneously using the WindowsDirect communication function...

This is possible with the EP-80 and EP-90 electronic printers. For details, refer to the printer instruction manuals.

When using a printer, connect it to the balance by following the procedure below.

- 1** Turn off the power to the balance and the printer.

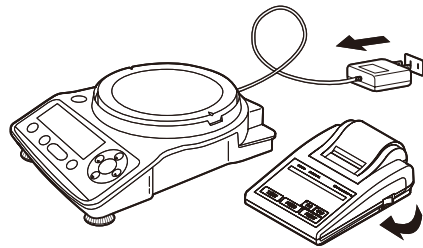

- 2** Using the cable supplied as an accessory with the printer, securely connect the DATA I/O connector at the balance and the connector at the printer.

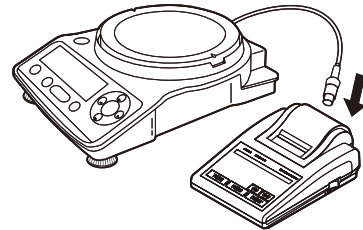

- 3** Turn on the power to the balance.

- 4** Turn on the power to the printer.

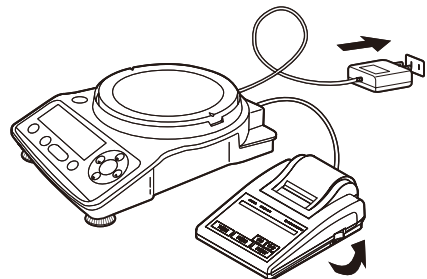

What to do if...

- ◆ When turning the power off, turn off the power to the printer first, then the power to the balance.
- ◆ For more information on the printer, see the printer instruction manual.

# Communication Settings

This section explains the menu settings that determine the communication specifications when the balance is connected to a PC, printer, or other device.

For information on the WindowsDirect communication function, see "WindowsDirect Communication Function" (👉 page 111).

The settings made here are effective simultaneously for RS-232C and the DATA I/O communication ports. If you are connecting the printer to the DATA I/O connector, set the communication specifications of the balance to "MODE1".

The default setting is "MODE1".

Apart from this default setting, another five modes comprising frequently used combinations of communication settings are provided.

Selecting one of the settings from "MODE1" to "MODE5" allows you to set all of the following items at once: baud rate (communication speed), parity (bit length), stop bit, handshake, data format, delimiter.  
👉 "Standard Settings (MODE)", page 126

The user can set each item according to requirements.  
👉 "User-Specified Settings", page 126

|                                      | WindowsDirect Communication | Standard Settings 1 | Standard Settings 2         | Standard Settings 3 | Standard Settings 4 | Standard Settings 5 | User-Specified Settings |
|--------------------------------------|-----------------------------|---------------------|-----------------------------|---------------------|---------------------|---------------------|-------------------------|
| Display with user-specified settings | WINI etc.                   | MODE.1              | MODE.2                      | MODE.3              | MODE.4              | MODE.5              | MODE.U                  |
| Relevant manufacturer                | Shimadzu                    | Shimadzu (standard) | Shimadzu (responses given*) | Mettler             | Sartorius           | A&D                 | -                       |
| Baud rate (communication speed)      | 300                         | 1200                | 1200                        | 2400                | 1200                | 2400                | Any required setting    |
| Parity (bit length)                  | None (8)                    | None (8)            | None (8)                    | Even (7)            | Odd (7)             | Even (7)            | Any required setting    |
| Stop bit                             | 1                           | 1                   | 1                           | 2                   | 2                   | 2                   | Any required setting    |
| Handshake                            | Hardware                    | Hardware            | Hardware                    | OFF                 | Hardware            | OFF                 | Any required setting    |
| Data format                          | WindowsDirect communication | Shimadzu standard   | Shimadzu standard           | Mettler standard    | Sartorius standard  | A&D standard        | Any required setting    |
| Delimiter                            | WindowsDirect communication | C/R                 | C/R                         | C/R+L/F             | C/R+L/F             | C/R+L/F             | Any required setting    |

\* The balance can return responses to commands from a PC.  
When a command is received normally, OK (C/R) is returned and when a command is received abnormally, NG (C/R) is returned.

▽ Communication Settings

## Standard Settings (MODE)

Make a selection from the setting combinations "MODE1" to "MODE4".

- 1 Press **PRINT** for about 3 seconds in the weighing mode.

This opens the output menu.

- 2 Select communication setting.

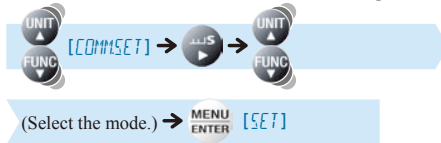

- When "MODE2" is selected



- 3 Return to the weighing mode.

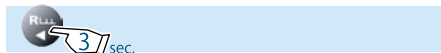

## User-Specified Settings

In this setting each of the communication settings can be set according to the user's requirements.

- 1 Press **PRINT** for about 3 seconds in the weighing mode.

This opens the output menu.

- 2 Select user-specified setting.

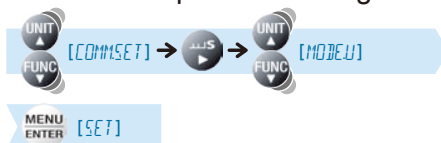

### 3 Make the communication settings according to your own requirements.

Set the following items as necessary.

#### Setting the baud rate (communication speed)

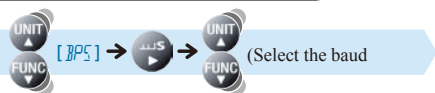

rate.) MENU ENTER [SET]



|            |         |         |          |          |          |          |           |           |
|------------|---------|---------|----------|----------|----------|----------|-----------|-----------|
| Indication | B.300   | B.600   | B.1200   | B.2400   | B.4800   | B.9600   | B.19.2k   | B.38.4k   |
| Baud rate  | 300 bps | 600 bps | 1200 bps | 2400 bps | 4800 bps | 9600 bps | 19.2k bps | 38.4k bps |

#### Setting the parity (bit length)



parity.) MENU ENTER [SET]



|                     |                         |                          |                           |
|---------------------|-------------------------|--------------------------|---------------------------|
| Indication          | P.NONE                  | P.ODD                    | P.EVEN                    |
| Parity (bit length) | No parity, 8-bit length | Odd parity, 7-bit length | Even parity, 7-bit length |

#### Setting the stop bit



bit.) MENU ENTER [SET]



|            |                  |                   |
|------------|------------------|-------------------|
| Indication | S. 1             | S. 2              |
| Stop bit   | Stop bit = 1 bit | Stop bit = 2 bits |

#### Setting the handshake



of handshake.) MENU ENTER [SET]



|            |              |                    |                    |                 |
|------------|--------------|--------------------|--------------------|-----------------|
| Indication | HS.OFF       | HS.HW              | HS.SW              | HS.TIM          |
| Handshake  | No handshake | Hardware handshake | Software handshake | Timer handshake |

## ▽ Communication Settings



### What to do if...

The default setting is "hardware handshake".

- ◆ When connecting to a printer, select "hardware handshake".
- ◆ When connecting to a PC, select "no handshake".

### Setting the data format

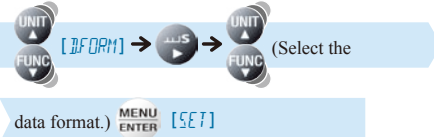

| Indication  | DF.1                                                             | DF.2                                                | DF.3                                                  | DF.4                                                   | DF.FRE                                                                                                                                                                                                  |
|-------------|------------------------------------------------------------------|-----------------------------------------------------|-------------------------------------------------------|--------------------------------------------------------|---------------------------------------------------------------------------------------------------------------------------------------------------------------------------------------------------------|
|             | Data format 1                                                    | Data format 2                                       | Data format 3                                         | Data format 4                                          | Free format                                                                                                                                                                                             |
| Data format | This is Shimadzu's standard format. Normally, make this setting. | This is an expansion of the data format 1 function. | This is the same format as used by Mettler balances.S | This is the same format as used by Sartorius balances. | This is a format that allows the leading bytes and number of send data to be set freely. The leading bytes can be set in the range 1 to 17 and the number of send data can be set in the range 8 to 23. |

### Setting a delimiter

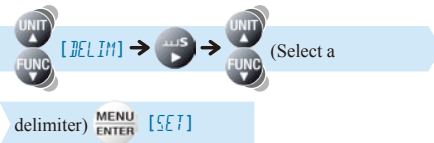

Delimiter: A symbol used to partition individual data items and individual commands

|            |    |    |       |       |                               |
|------------|----|----|-------|-------|-------------------------------|
| Indication | CR | LF | CR+LF | COMMA | WIN<br>WIN-U<br>WIN-<br>WIN-U |
| Delimiter  | CR | LF | CR+LF | Comma | WindowsDirect communication * |

\* Batch set all of the communication settings for the WindowsDirect communication function by following the procedure in "Setting the Function" (page 111).

## 4 Return to the weighing mode.

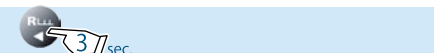



# Output Timing Change Function

Data can be set to output without waiting for detection of stability (immediate output), or to output only after detecting stability (output after stability), when **PRINT** is pressed.

- 1 Press **PRINT** for about 3 seconds in the weighing mode.

This opens the output menu.

- 2 Select the output timing change function.



| Stability Mark | Output Timing Change Function        |
|----------------|--------------------------------------|
| Lit            | When "immediate output" is set       |
| Unlit          | When "output after stability" is set |

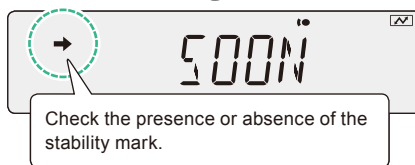

- 3 Change the setting.

Pressing **MENU ENTER** alternately selects "immediate output" and "output after stability".

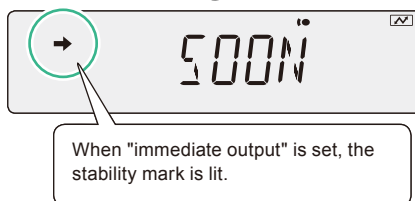

- 4 Return to the weighing mode.

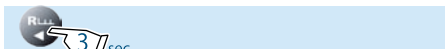

# 11 MAINTENANCE

## Maintaining the Balance

### ⚠ Caution



Instructions

Before starting maintenance on the balance, disconnect the AC adapter from the power outlet.

If you carry out maintenance with the AC adapter left plugged into the power outlet, you may sustain an electric shock.

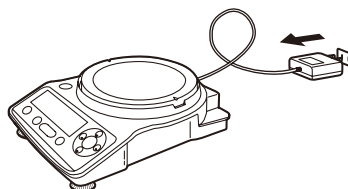

### Pan

The pan can be removed from the body of the balance and washed with water.

Dry it thoroughly before fitting it back on the balance.



### Main body

Wipe over with a soft cloth moistened with a little neutral detergent and well wrung out.

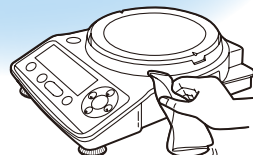

### Glass door

The door can be removed and the door rails can be wiped over or replaced.

For details on how to remove the door, see "Removing the Glass Door" (📖 page 131).

### Display

Avoid using organic solvents, chemical agents or cloths impregnated with chemicals since they will damage the coating of the balance and the display panel.

If the balance is used in an environment where it gets dirty easily, use the protective in-use cover available as a special accessory (option).

## Removing the Glass Door

With small pan models of the TW/TX series of balances, the glass door can be removed to clean the door rails.

### Caution



Instructions

Handle the glass door with due care.

- Take care when handling the glass door so as not to crack it.
- Take care not to injure your hands on the door rail.
- Exercise due care when handling broken glass.

## 1 Remove the pan and pan supporter.

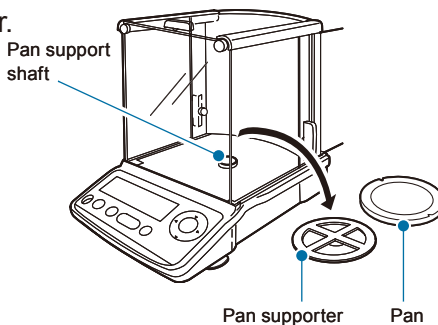

## 2 Turn the knob on the inner side of the handle to remove the handle.

### Caution



Prohibitions

Do not touch the pan support shaft.  
This could damage the balance.

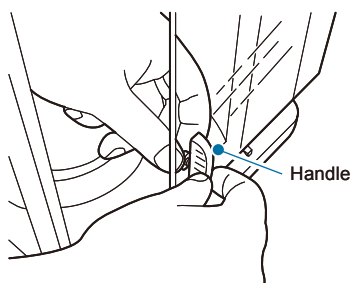

## 3 Pull the glass door out from the rear.

### Caution



Instructions

When fitting the glass door, be sure to fit the knob.  
If you forget to fit the knob the glass door could fall off.

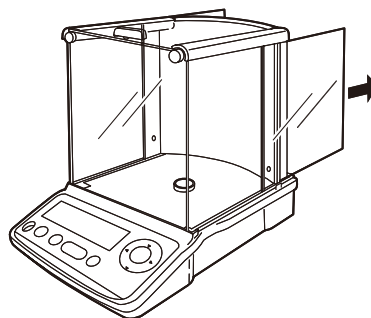

# Inspection

Since the balance may develop error due to its application and environment of use, it must undergo both daily and periodic inspections in order to properly maintain its required performance and functions.

However, since the management standards governing the content of these inspections (methods, judgment criteria, etc.) will differ depending on the purpose of use, management goals, they must be determined by the customer.

If the content of the inspections is made too lax, the risk that you will continue to use the balance without discovering an abnormality increases, but if it is excessively strict it may reduce working efficiency, so you should take the care to devise balanced inspection content, considering the risks, the performance that is required in the work to be done.

This section indicates the guidelines for daily inspections and periodic inspections.

Please use these guidelines for reference when deciding the practical details of your own inspections.

## Daily Inspections

Daily inspections are inspections performed on a daily basis (for example before starting work) by the person who actually uses (or manages) the balance.

The points inspected in daily inspections can, if you like, be reduced to the minimum necessary.

Here are some examples for your reference.

|                         | Daily Inspection<br>[Reference Example 1]                                                                                                                                                     | Daily Inspection<br>[Reference Example 2]                                                                                                                                                                                            |
|-------------------------|-----------------------------------------------------------------------------------------------------------------------------------------------------------------------------------------------|--------------------------------------------------------------------------------------------------------------------------------------------------------------------------------------------------------------------------------------|
| Frequency of inspection | Once per day                                                                                                                                                                                  | Once to several times per day (as required)                                                                                                                                                                                          |
| Inspection timing       | Before the start of work                                                                                                                                                                      | Before the start of work and when performing important weighing operations                                                                                                                                                           |
| Method of inspection    | Observe the instrumental error at a single point.<br>Set the "observation point" as a point a little above the upper limit value of the range in which the balance is actually used to weigh. | Observe the instrumental error at a single point. As the point to be observed before the start of work, set a point a little above the upper limit value of the range in which it is possible that actual measurements will be made. |
| Criterion of judgment   | To be accurate to within $\pm 5$ at one decimal place to the right of the digit where accuracy is required when actually weighing with the balance.                                           | To be accurate to within $\pm 5$ at one decimal place to the right of the digit where accuracy is required when actually weighing with the balance.                                                                                  |



### What is instrumental error?

This is the amount of the discrepancy between the value indicated by the balance and the correct value.

It is assessed as the difference between the weight reading when a weight that corresponds to the observation point is weighed on the balance and the actual weight value of that weight.

For details on weights, see "About Weights" (🔗 page 134).

## Periodic Inspections

Periodic inspections are inspections that are performed periodically (for example once a year). The content of periodic inspections must cover all aspects including performance and functions.

An overview is given below.

| Overview of Periodic Inspection [Reference Example] |                                                                                                                                                                                                                                                                                                                                                                                                                                                                                                                                                                                                                                                                                                                                                                                                                                                                                                                                                                                                                                                                                 |
|-----------------------------------------------------|---------------------------------------------------------------------------------------------------------------------------------------------------------------------------------------------------------------------------------------------------------------------------------------------------------------------------------------------------------------------------------------------------------------------------------------------------------------------------------------------------------------------------------------------------------------------------------------------------------------------------------------------------------------------------------------------------------------------------------------------------------------------------------------------------------------------------------------------------------------------------------------------------------------------------------------------------------------------------------------------------------------------------------------------------------------------------------|
| Frequency of inspection                             | Once a year                                                                                                                                                                                                                                                                                                                                                                                                                                                                                                                                                                                                                                                                                                                                                                                                                                                                                                                                                                                                                                                                     |
| Inspection timing                                   | Any day during the established month                                                                                                                                                                                                                                                                                                                                                                                                                                                                                                                                                                                                                                                                                                                                                                                                                                                                                                                                                                                                                                            |
| Method of inspection                                | <p>Check for abnormalities in the following functions and external appearance.</p> <ul style="list-style-type: none"> <li>• Display panel</li> <li>• Menu operation keys / operation keys</li> <li>• Pan</li> <li>• Level</li> </ul> <p>Check the following aspects of performance.</p> <ul style="list-style-type: none"> <li>• Repeatability: Weigh a weight that corresponds to approximately half of the weighing capacity of the balance five to ten times and assess the dispersion in the weight readings obtained.</li> <li>• Eccentric error: Assess the difference in the weight readings obtained when a weight corresponding to one fourth to one third of the weighing capacity of the balance is placed in the center of the pan and at a position shifted from the center by a specified distance.</li> <li>• Instrumental error: Decide on three to five observation points and assess the difference between the values obtained when weights corresponding to these points are weighed on the balance and the actual weight values of the weights.</li> </ul> |
| Criterion of judgment                               | To be accurate to within $\pm 5$ at one decimal place to the right of the digit where accuracy is required when actually weighing with the balance.                                                                                                                                                                                                                                                                                                                                                                                                                                                                                                                                                                                                                                                                                                                                                                                                                                                                                                                             |

For details on weights, see "About Weights" ( page 134).

# About Weights

In order to establish and maintain the performance of the balance, weights must be used to accurately adjust the balance's scale, and to check its adjustment.

With the TW/TX/TXB series balances, weights are used when performing calibration (🔧 page 54) and inspections (🔍 page 132) in the environment in which the balance is actually used. The weights should be prepared in advance and managed properly.

## Types of Weight and Their Selection

There are many types of weights.

Select the appropriate weights for the specifications of your balance by referring to the following table.

### ◆ Selecting the class of weight

As the main form of classification, weights are normally divided into classes according to their degree of accuracy.

Select the most appropriate class of weights to be used for calibration and inspection of the balance, based on the type of the balance.

The table below shows the classes of weight and the applicable balances.

| Class of Weight | Applicable Type of Balance |                              |                     |
|-----------------|----------------------------|------------------------------|---------------------|
|                 | Minimum Indication         | Resolution*                  | Common Name         |
| E2              | Less than 1 mg             | Around 1/1,000,000 or better | Analytical balances |
| F1              | 1 mg or greater            | Around 1/100,000 or better   | Toploading balances |
| F2              | 1 mg or greater            | Around 1/100,000 or lower    | Toploading balances |
| M1              | 10 mg or greater           | Around 1/10,000 or better    | Scales, etc.        |

\* "Resolution" means: minimum indication / weighing capacity

#### ◆ Selecting the calibration weights to be used

Now you must select the "indicated weight" of the weight to be used (how many grams it should be).

The weights of weights are set with the smallest at 1 mg and progressing in the sequence 1 mg, 2 mg, 5 mg, ... as shown below.

1 mg, 2 mg, 5 mg, 10 mg ... 1 g, 2 g, 5 g, 10 g, 20 g, 50 g, 100 g ...

When selecting a weight to be used for calibrating a balance, you are recommended to select one that is close to the weighing capacity of the balance.

The table below shows the recommended calibration weights to be used for balances with different weighing capacities.

| Weighing Capacity of Balance | Recommended Weight of Weight for Calibration |
|------------------------------|----------------------------------------------|
| 64 g (320 ct)                | 60 g (50 g + 10 g)                           |
| 124 g (620 ct)               | 100 g                                        |
| 220 g                        | 200 g                                        |
| 320 g                        | 300 g (200 g + 100 g)                        |
| 420 g                        | 400 g (200 g + 200 g)                        |
| 620 g                        | 600 g (500 g + 100 g)                        |
| 2200 g                       | 2 kg                                         |
| 3200 g                       | 3 kg (2 kg + 1 kg)                           |
| 4200 g                       | 4 kg (2 kg + 2 kg)                           |
| 6200 g                       | 6 kg (5 kg + 1 kg)                           |



For information on the range of weights that can be used to calibrate balances (i.e. values that can be entered as the weight value) see "Calibration range with external weights" (👉 page 145) in "Specifications".

It is also possible to calibrate a balance with a weight that is not close to the weighing capacity of the balance.

However, if you do this, when weighing in the range that exceeds the weight value that was used for calibration, the performance may deteriorate proportionately (the instrumental error may become larger).





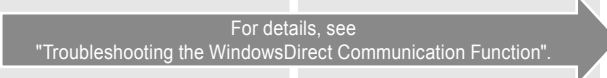





# 12 TROUBLESHOOTING

## What to Do If....

| Symptom                                                                                                                                                      | Probable Cause(s)                                                                                                                                                                                    | Countermeasure                                                                                                                                                                                                                           | See:     |
|--------------------------------------------------------------------------------------------------------------------------------------------------------------|------------------------------------------------------------------------------------------------------------------------------------------------------------------------------------------------------|------------------------------------------------------------------------------------------------------------------------------------------------------------------------------------------------------------------------------------------|----------|
| Nothing is displayed on the display panel.                                                                                                                   | <ul style="list-style-type: none"> <li>● The power cable is disconnected.</li> <li>● The main switch on the distribution panel is off.</li> <li>● The power supply voltage is wrong.</li> </ul>      | <ul style="list-style-type: none"> <li>● Check the power supply and voltage and make the connections correctly.</li> </ul>                                                                                                               | Page 145 |
| The display doesn't change when a sample (item to be weighed) is placed on the pan.                                                                          | <ul style="list-style-type: none"> <li>● The pan has been displaced.</li> </ul>                                                                                                                      | <ul style="list-style-type: none"> <li>● Set the pan correctly on the balance.</li> </ul>                                                                                                                                                | Page 27  |
| The display fluctuates and  (the stability mark) does not appear readily. | <ul style="list-style-type: none"> <li>● The balance has been installed in an unstable environment.</li> </ul>                                                                                       | <ul style="list-style-type: none"> <li>● Eliminate the effects of vibration and air movement.</li> <li>● Install the balance on a robust platform.</li> </ul>                                                                            | Page 24  |
|                                                                                                                                                              | <ul style="list-style-type: none"> <li>● The pan supporter caps (TX series large pan models only) have come off.</li> </ul>                                                                          | <ul style="list-style-type: none"> <li>● Fit the pan supporter caps (TX series large pan models only).</li> </ul>                                                                                                                        | Page 27  |
|                                                                                                                                                              | <ul style="list-style-type: none"> <li>● The protective in-use cover is touching the pan.</li> <li>● The glass door of the windbreak is open (TW/TX series small pan models only).</li> </ul>        | <ul style="list-style-type: none"> <li>● When using the protective in-use cover, make sure that it is fitted snugly against the surface of the balance body.</li> <li>● Close all the glass doors before reading the display.</li> </ul> | —        |
| The weighing result is not accurate.                                                                                                                         | <ul style="list-style-type: none"> <li>● Span calibration has not been performed.</li> </ul>                                                                                                         | <ul style="list-style-type: none"> <li>● Perform span calibration.</li> </ul>                                                                                                                                                            | Page 56  |
|                                                                                                                                                              | <ul style="list-style-type: none"> <li>● Is the display at zero before weighing?</li> </ul>                                                                                                          | <ul style="list-style-type: none"> <li>● Press  to set the display at zero before weighing.</li> </ul>                                                | Page 38  |
| The units that you want to use are not displayed.                                                                                                            | <ul style="list-style-type: none"> <li>● The units that you want to use have not been set.</li> </ul>                                                                                                | <ul style="list-style-type: none"> <li>● Set the units that you want to use for .</li> </ul>                                                          | Page 83  |
| Menu operations are not possible.                                                                                                                            | <ul style="list-style-type: none"> <li>● Menu operation is locked.</li> </ul>                                                                                                                        | <ul style="list-style-type: none"> <li>● Release the menu lock.</li> </ul>                                                                                                                                                               | Page 52  |
| The WindowsDirect communication function cannot be used.                                                                                                     | <p style="text-align: center;">For details, see  "Troubleshooting the WindowsDirect Communication Function".</p> |                                                                                                                                                                                                                                          | Page 116 |

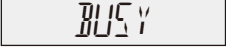

## Responding to Messages

| Message Display                                                                                                                                                                          | Probable Cause(s)                                                                                                                                                                                                                                 | Countermeasure                                                                                                                                                                                                                                                                                                                                                                                                                                                                                | See:                |
|------------------------------------------------------------------------------------------------------------------------------------------------------------------------------------------|---------------------------------------------------------------------------------------------------------------------------------------------------------------------------------------------------------------------------------------------------|-----------------------------------------------------------------------------------------------------------------------------------------------------------------------------------------------------------------------------------------------------------------------------------------------------------------------------------------------------------------------------------------------------------------------------------------------------------------------------------------------|---------------------|
| <br>(Hardware error)                                                                                    | <ul style="list-style-type: none"> <li>There is a fault in the hardware, such as the temperature sensor or internal weight mechanism (TW series only).</li> <li>There is an error in the internal system data.</li> </ul>                         | <ul style="list-style-type: none"> <li>Disconnect the AC adaptor or remove the batteries and turn the power back ON. If the same message is still displayed, contact your Shimadzu representative.</li> </ul>                                                                                                                                                                                                                                                                                 | Page 31             |
| <br>(Span calibration error)                                                                            | <ul style="list-style-type: none"> <li>The balance has a large drift of the zero point or sensitivity.</li> <li>A container is placed on the pan.</li> <li>The pan is displaced.</li> <li>The wrong weight has been placed on the pan.</li> </ul> | <ul style="list-style-type: none"> <li>Press  ( with the TXB series) to return to the weighing mode. Place the correct weight in the center of the pan.</li> <li>After checking that the pan is correctly installed and that nothing is placed on it, turn the power back ON and execute span calibration again.</li> </ul> | Page 56<br>Page 60  |
| <br>(Numerical value entry error)                                                                       | <ul style="list-style-type: none"> <li>Either a mistake has been made when entering the value or the value is not appropriate.</li> </ul>                                                                                                         | <ul style="list-style-type: none"> <li>After the error is displayed, the balance returns to the status immediately before the error occurred. Enter the correct numerical value.</li> </ul>                                                                                                                                                                                                                                                                                                   | Page 49             |
| <br>(Operation error)                                                                                 | <ul style="list-style-type: none"> <li>The operation used is wrong.</li> </ul>                                                                                                                                                                    | <ul style="list-style-type: none"> <li>After the error is displayed, the balance returns to the status immediately before the error occurred. At this point, follow the correct operation.</li> </ul>                                                                                                                                                                                                                                                                                         | —                   |
| <br>(External input error)                                                                            | <ul style="list-style-type: none"> <li>An unrecognizable command code has been received.</li> </ul>                                                                                                                                               | <ul style="list-style-type: none"> <li>After the error is displayed, the balance returns to the status immediately before the error occurred. At this point, set the correct command code.</li> </ul>                                                                                                                                                                                                                                                                                         | Page 120            |
| <br><br>(overload) | <ul style="list-style-type: none"> <li>The pan is displaced.</li> <li>The pan supporter caps (TX series large pan models only) have come off.</li> <li>The weighing capacity has been exceeded.</li> </ul>                                        | <ul style="list-style-type: none"> <li>Set the pan correctly on the balance.</li> <li>Fit the pan supporter caps (TX series large pan models only).</li> <li>Use the balance within its weighing capacity.</li> </ul>                                                                                                                                                                                                                                                                         | Page 27<br>Page 145 |
| <br>(Operation aborted)                                                                               | <ul style="list-style-type: none"> <li>The calibration or standard value setting operation has been aborted.</li> </ul>                                                                                                                           | <ul style="list-style-type: none"> <li>After this is displayed, the balance returns to the operable state.</li> </ul>                                                                                                                                                                                                                                                                                                                                                                         | —                   |
| <br>(Waiting for permission for the operation)                                                        | <ul style="list-style-type: none"> <li>This message is displayed in order to avoid unnecessary key operations.</li> </ul>                                                                                                                         | <ul style="list-style-type: none"> <li>After this is displayed, the balance returns to the operable state.</li> </ul>                                                                                                                                                                                                                                                                                                                                                                         | —                   |
| <br>(Load detected)                                                                                   | <ul style="list-style-type: none"> <li>There was something placed on the pan when calibration was started.</li> </ul>                                                                                                                             | <ul style="list-style-type: none"> <li>Take the item off the pan. The message will be cleared automatically and you will be able to continue calibration.</li> </ul>                                                                                                                                                                                                                                                                                                                          | Page 56             |

# 13 FOR YOUR INFORMATION

## Turning the Power ON and OFF

### Auto Power-Off Function

When the auto power-off function is turned on, the liquid crystal display will go fully off or the power will be shut off automatically if there is no weighing or key operation during the set time.

- TW/TX series: The liquid crystal display goes fully off.
- TXB series: The power is shut off.

**1** Press **MENU ENTER** in the weighing mode.

This opens the main menu.

**2** Select the auto power-OFF function.

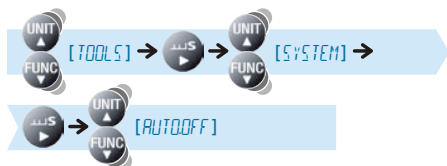

Check the presence or absence of the stability mark.



What is the current situation?

| Stability Mark | Auto Power-Off Function |
|----------------|-------------------------|
| Lit            | ON                      |
| Unlit          | OFF                     |

What do you want to do?

| To Set / Update                                   | To Cancel                                         |
|---------------------------------------------------|---------------------------------------------------|
| Press <b>←</b> and go to step <b>3</b> .          | Press <b>MENU ENTER</b> and go to step <b>4</b> . |
| Press <b>MENU ENTER</b> and go to step <b>3</b> . | Go to step <b>4</b> .                             |

**3** Enter the time (in minutes).

(Enter the time (in minutes).) → **MENU ENTER** [SET]

"Entering Numerical Values", page 49

Setting time for auto power-off function

---

The upper limit time which can be set for the auto power-off function is 10 minutes.



**4** Return to the weighing mode.

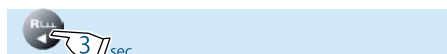

## Setting the Startup Display

Select the startup display from one of the three following types.

|                         |                                                                                                                                                                                                                                                                                                                                        |
|-------------------------|----------------------------------------------------------------------------------------------------------------------------------------------------------------------------------------------------------------------------------------------------------------------------------------------------------------------------------------|
| <b>Weighing mode</b>    | After the power is turned on, the balance proceeds automatically to the weighing mode.                                                                                                                                                                                                                                                 |
| <b>OFF display</b>      | After the power is turned on, the balance stops with the "OFF display". When any of the keys is pressed during the OFF display the balance automatically proceeds to the all segments lit display and then to the weighing mode.                                                                                                       |
| <b>All segments lit</b> | After the power is turned on, the balance stops with the "OFF display". When any of the keys is pressed during the OFF display, the balance stops with all display segments lit. Pressing  while all segments are lit takes you to the weighing mode. |

### 1 Press in the weighing mode.

This opens the main menu.

### 2 Select setting of the startup display.

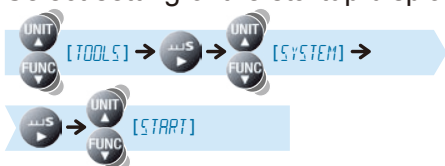

### 3 Select the type of startup display.

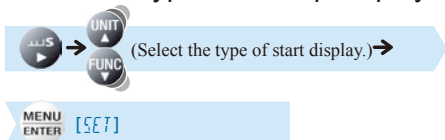

➔ (the stability mark) lights up for the set start display.

- Weighing mode



- OFF display



- All segments lit



### 4 Return to the weighing mode.

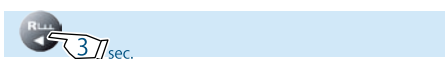

The startup display is now set.

## Backlight ON/OFF (TXB Only)

This setting can only be made with TXB series balances (with the TW/TX series, the backlight is ON all the time).

- Press  in the weighing mode.  
This opens the main menu.

- Select the backlight.

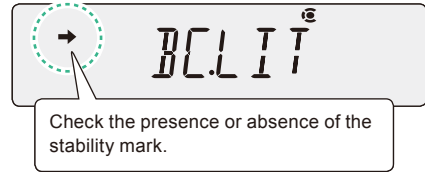
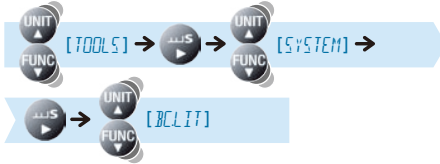

| Stability Mark | Backlight |
|----------------|-----------|
| Lit            | ON        |
| Unlit          | OFF       |

- Change the setting.

Pressing  alternately sets the ON and OFF settings.



- Return to the weighing mode.

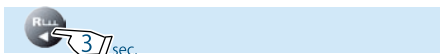

### Backlight auto OFF

Even when the backlight setting is made ON (lit), the backlight automatically goes off if there is no key operation or change in the loading status on the pan for 15 seconds.

# Changing the Password

To execute menu reset (☞ page 51), to set or cancel menu lock (☞ page 52), or to execute calibration of the internal weight (☞ page 64), you have to input a password.

"9999" is set as the default password, but this can be changed by following the procedure below.

- 1 Press **MENU** **ENTER** in the weighing mode.

This opens the main menu.

- 2 Select the password.

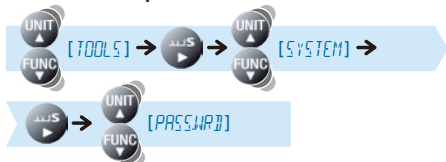

- 3 Enter the current password.

**MENU** **ENTER** (Enter the current password.)



- 4 Enter the new password.

**MENU** **ENTER** [OK] (Enter the current password.)

☞ "Entering Numerical Values", page 49



- 5 Confirm.

**MENU** **ENTER** [OK?]

To cancel at this point, press **POWER** (with the TXB series). The balance will return to the status after step 2, without setting the value entered in step 3.

To confirm the password, proceed as follows.

**MENU** **ENTER** [SET] → [PASSWORD]



- 6 Return to the weighing mode.

**RELEASE** 3 sec.



## GLP Output Function

On turning the GLP output function ON, you can add the balance ID and other information to the calibration record (👉 page 67) and weight reading outputs.

Example printout from printer  
(When the GLP output function is set to ON)

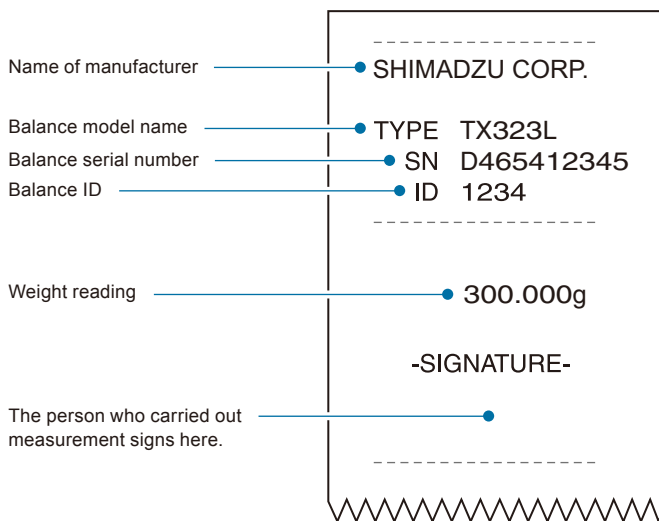

### Setting the GLP Output Function

**1** Press **CAL** for about 3 seconds.

This opens the calibration menu.

**2** Select the GLP output function.

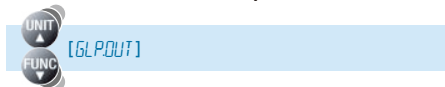

| Stability Mark | GLP Output Function |
|----------------|---------------------|
| Lit            | ON                  |
| Unlit          | OFF                 |

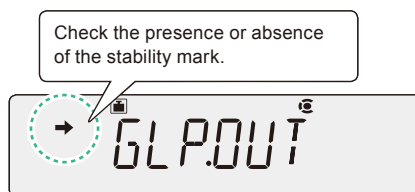

### 3 Change the setting.

Pressing  alternately sets the ON and OFF settings.

 [SET]



When ON is set the stability mark is lit.

### 4 Return to the weighing mode.

 3 sec.



On setting the GLP output function to ON and outputting weight readings...

A long time is required to output one weight reading.

In addition, when the balance is used in combination with both a PC and printer (option), data may not be printed correctly at the printer. See the setting conditions below.

| Handshake Settings in the Communication Settings (👉 page 126) | Rough Time Required for Output of One Weight Reading |                 |                                   |
|---------------------------------------------------------------|------------------------------------------------------|-----------------|-----------------------------------|
|                                                               | Printer Only                                         | PC Only         | Both Printer and PC used          |
| OFF                                                           | Approx. 10 sec.                                      | Approx. 10 sec. | Correct printing is not possible  |
| SW (software)                                                 | Approx. 33 sec.                                      | Approx. 33 sec. | Approx. 33 sec.                   |
| HW (hardware)                                                 | Approx. 10 sec.                                      | Approx. 10 sec. | Correct printing is not possible. |
| TIM (timer)                                                   | Approx. 60 sec.                                      | Approx. 60 sec. | Approx. 60 sec.                   |



On setting the GLP output function to ON and using the command code "D01 (continuous output)"...

No items other than weight readings are output.

## ■ Setting a Balance ID

When managing multiple balances, by setting a four-digit management number (ID) and turning the GLP output function ON, you can add the balance ID to calibration records (👉 page 67) and weight reading outputs.

**1** Press  in the weighing mode.

This opens the main menu.

**2** Select setting of a balance ID.

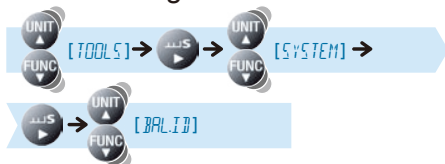

**3** Enter the required numerals (max. 4 digits).



👉 "Entering Numerical Values", page 49

The default ID is "0000".



**4** Return to the weighing mode.





# Specifications

## TW/TX Series

| Model Name                                           | TWC323L<br>TXC323L                         | TWC623L<br>TXC623L     | TW223L<br>TX223L                         | TW323L<br>TX323L | TW423L<br>TX423L | TX2202L                                  | TX3202L       | TX4202L       |
|------------------------------------------------------|--------------------------------------------|------------------------|------------------------------------------|------------------|------------------|------------------------------------------|---------------|---------------|
| Weighing capacity                                    | 320 ct<br>(64 g)                           | 620 ct<br>(124 g)      | 220 g                                    | 320 g            | 420 g            | 2200 g                                   | 3200 g        | 4200 g        |
| Minimum indication                                   | 0.001 ct<br>(0.0002 g)                     | 0.001 ct<br>(0.0002 g) | 0.001 g                                  | 0.001 g          | 0.001 g          | 0.01 g                                   | 0.01 g        | 0.01 g        |
| Range of external weights for calibration            | 10 - 64 g                                  | 10 - 124 g             | 100 - 220 g                              | 100 - 320 g      | 100 - 420 g      | 1000 - 2200 g                            | 1000 - 3200 g | 1000 - 4200 g |
| Repeatability (standard deviation)                   | ≤ 0.0002 g                                 |                        | ≤ 0.001 g                                |                  |                  | ≤ 0.01 g                                 |               |               |
| Linearity                                            | ± 0.0004 g                                 |                        | ± 0.002 g                                |                  |                  | ± 0.02 g                                 |               |               |
| Response time *1                                     | 3.0 seconds                                |                        | 2.5 seconds                              |                  |                  |                                          |               |               |
| Ambient temperature                                  | 5 - 40 °C                                  |                        |                                          |                  |                  |                                          |               |               |
| Temperature coefficient for sensitivity (10 - 30 °C) | ± 3 ppm/°C                                 |                        |                                          |                  |                  |                                          |               |               |
| Pan size (mm)                                        | Approx. φ80                                |                        | Approx. φ110                             |                  |                  | Approx. 167 (W) × 181 (D) *2             |               |               |
| Main body dimensions (mm)                            | Approx. 206 (W) × 291 (D) × 241 (H)        |                        |                                          |                  |                  | Approx. 200 (W) × 291 (D) × 80 (H)       |               |               |
| Main body weight                                     | TWC: approx. 4.1 kg<br>TXC: approx. 3.8 kg |                        | TW: approx. 4.2 kg<br>TX: approx. 3.8 kg |                  |                  | TW: approx. 3.2 kg<br>TX: approx. 2.8 kg |               |               |
| Display                                              | LCD with backlight                         |                        |                                          |                  |                  |                                          |               |               |
| Power requirements                                   | AC adaptor (Output 12 V, 1 A)              |                        |                                          |                  |                  |                                          |               |               |
| I/O terminal                                         | RS-232C, DATA I/O                          |                        |                                          |                  |                  |                                          |               |               |

\*1 The response time is a representative value.

\*2 The size of the pan is the dimension of the face on which the sample (thing being weighed) is placed. The dimension expresses the flat face size of the pan. Since the pan has a tapered shape, its outer dimension is a little larger.

▽ Specifications

## TXB Series

| Model Name                                           | TXB222L                            | TXB422L                                                                                                   | TXB622L     | TXB2201L      |
|------------------------------------------------------|------------------------------------|-----------------------------------------------------------------------------------------------------------|-------------|---------------|
| Weighing capacity                                    | 220 g                              | 420 g                                                                                                     | 620 g       | 2200 g        |
| Minimum indication                                   | 0.01 g                             |                                                                                                           |             | 0.1 g         |
| Range of external weights for calibration            | 100 - 220 g                        | 100 - 420 g                                                                                               | 100 - 620 g | 1000 - 2200 g |
| Repeatability (standard deviation)                   | ≤ 0.01 g                           |                                                                                                           |             | ≤ 0.1 g       |
| Linearity                                            | ± 0.01 g                           | ± 0.02 g                                                                                                  |             | ± 0.1 g       |
| Response time * <sup>1</sup>                         | 2.0 seconds                        |                                                                                                           |             |               |
| Ambient temperature                                  | 5 - 40 °C                          |                                                                                                           |             |               |
| Temperature coefficient for sensitivity (10 - 30 °C) | ± 15 ppm/°C                        | ± 10 ppm/°C                                                                                               | ± 5 ppm/°C  | ± 15 ppm/°C   |
| Pan size (mm)                                        | φ110                               |                                                                                                           |             | φ160          |
| Main body dimensions (mm)                            | Approx. 199 (W) × 260 (D) × 77 (H) |                                                                                                           |             |               |
| Main body weight                                     | Approx. 1.5 kg                     |                                                                                                           |             |               |
| Display                                              | LCD with backlight                 |                                                                                                           |             |               |
| Power requirements                                   | AC adaptor                         | Output 12 V, 1 A                                                                                          |             |               |
|                                                      | Dry cell batteries                 | Six size AA alkaline dry cell batteries<br>For 40 hours of continuous use (Back light off) * <sup>2</sup> |             |               |
| I/O terminal                                         | RS-232C, DATA I/O                  |                                                                                                           |             |               |

| Model Name                                           | TXB4201L                           | TXB6201L                                                                                                  | TXB621L     | TXB6200L      |
|------------------------------------------------------|------------------------------------|-----------------------------------------------------------------------------------------------------------|-------------|---------------|
| Weighing capacity                                    | 4200 g                             | 6200 g                                                                                                    | 620 g       | 6200 g        |
| Minimum Indication                                   | 0.1 g                              |                                                                                                           |             | 1 g           |
| Range of external weights for calibration            | 1000 - 4200 g                      | 1000 - 6200 g                                                                                             | 100 - 620 g | 1000 - 6200 g |
| Repeatability (standard deviation)                   | ≤ 0.1 g                            |                                                                                                           |             | ≤ 1 g         |
| Linearity                                            | ± 0.2 g                            |                                                                                                           | ± 0.1 g     | ± 1 g         |
| Response time * <sup>1</sup>                         | 2.0 seconds                        |                                                                                                           |             |               |
| Ambient temperature                                  | 5 - 40 °C                          |                                                                                                           |             |               |
| Temperature coefficient for sensitivity (10 - 30 °C) | ± 10 ppm/°C                        | ± 5 ppm/°C                                                                                                | ± 20 ppm/°C |               |
| Pan size (mm)                                        | φ160                               |                                                                                                           | φ110        | φ160          |
| Main body dimensions (mm)                            | Approx. 199 (W) × 260 (D) × 77 (H) |                                                                                                           |             |               |
| Main body weight                                     | Approx. 1.5 kg                     |                                                                                                           |             |               |
| Display                                              | LCD with backlight                 |                                                                                                           |             |               |
| Power requirements                                   | AC adaptor                         | Output 12 V, 1 A                                                                                          |             |               |
|                                                      | Dry cell batteries                 | Six size AA alkaline dry cell batteries<br>For 40 hours of continuous use (Back light off) * <sup>2</sup> |             |               |
| I/O terminal                                         | RS-232C, DATA I/O                  |                                                                                                           |             |               |

\*<sup>1</sup> The response time is a representative value.

\*<sup>2</sup> When the backlight is lit, the time that the balance can be used continuously is reduced.

# Maintenance Parts

## TW/TX Series

### ◆ Maintenance parts list

| Part Name                     | Part Number (P/N) | Remarks                                 |
|-------------------------------|-------------------|-----------------------------------------|
| Pan (large pan)               | 321-64587         |                                         |
| Pan (small pan)               | 321-41418-10      |                                         |
| Pan (carat)                   | 321-41225         | TW/TX series for carat use              |
| Pan with grip                 | 321-41906-01      | TW/TX series for carat use              |
| Pan ring                      | 321-41205-11      | TW/TX series for carat use              |
| Pan supporter (small pan)     | 321-64589         |                                         |
| Pan supporter (carat)         | 321-64518         | TW/TX series for carat use              |
| Underplate (small pan, carat) | 321-64593         | TW/TX series, small pan / for carat use |
| Pan supporter cap (large pan) | 321-64591         |                                         |
| Glass door ASSY (right)       | 321-64583-01      | TW/TX series, small pan / for carat use |
| Glass door ASSY (left)        | 321-64583-02      | TW/TX series, small pan / for carat use |
| Glass door ASSY (top)         | 321-64581         | TW/TX series, small pan / for carat use |
| Mounting knob for glass door  | 321-62787-01      | TW/TX series, small pan / for carat use |

### ◆ Optional

| Part Name                               | Part Number (P/N) | Remarks                                                                    |
|-----------------------------------------|-------------------|----------------------------------------------------------------------------|
| Electronic printer EP-80                | 321-62675         | Impact dot type, can be used with the WindowsDirect communication function |
| Electronic printer EP-90                | 321-62675-10      | The EP-80 with a numeric keypad                                            |
| RS-232C cable                           | 321-61967         | D-Sub 9-pin for DOS/V (length 1.5 m)                                       |
| USB – serial conversion kit             | 321-62520-05      | With cable (321-61967)                                                     |
| All-surface protective cover (5 pcs.)   | 321-64523-10      | Specifically for TX series large pan models                                |
| Display panel protective cover (5 pcs.) | 321-64522-10      | TW/TX series, small pan / for carat use                                    |
| Level screws                            | 321-64540         |                                                                            |

## ■ TXB Series

### ◆ Maintenance parts list

| Part Name                 | Part Number (P/N) | Remarks |
|---------------------------|-------------------|---------|
| Pan (large pan)           | 321-63871         |         |
| Pan (small pan)           | 321-41418-10      |         |
| Pan supporter (large pan) | 321-63873         |         |
| Pan supporter (small pan) | 321-63835         |         |
| Pan ring (large)          | 321-63830         |         |
| Pan ring (small)          | 321-63831         |         |
| Battery cover             | 321-63838         |         |

### ◆ Optional

| Part Name                               | Part Number (P/N) | Remarks                                                                    |
|-----------------------------------------|-------------------|----------------------------------------------------------------------------|
| Electronic printer EP-80                | 321-62675         | Impact dot type, can be used with the WindowsDirect communication function |
| Electronic printer EP-90                | 321-62675-10      | The EP-80 with a numeric keypad                                            |
| RS-232C cable                           | 321-61967         | D-Sub 9-pin for DOS/V (length 1.5 m)                                       |
| USB – serial conversion kit             | 321-62520-05      | With cable (321-61967)                                                     |
| All-surface protective cover (5 pcs.)   | 321-63827-12      | Specifically for the TXB series (common to large pan and small pan)        |
| Display panel protective cover (5 pcs.) | 321-63827-11      | Specifically for the TXB series (common to large pan and small pan)        |
| Level screws                            | 321-64540         |                                                                            |

\* The part numbers, specifications, etc. indicated here are subject to change without notice.

## List of Functions That Can Be Used in Combination

A correspondence table for application functions, comparator functions and output functions is shown below. It shows whether functions can be used in combination with each other or not.

|                           |                                      | Application Function Mode |                     |             | Comparator  |                    | Output Functions                     |                   |            |                               |                     |
|---------------------------|--------------------------------------|---------------------------|---------------------|-------------|-------------|--------------------|--------------------------------------|-------------------|------------|-------------------------------|---------------------|
|                           |                                      | Piece Counting            | Percentage Weighing | Formulation | Target Mode | Checkweighing Mode | WindowsDirect Communication Function | Continuous Output | Auto Print | Output Timing Change Function | GLP output function |
| Application Function Mode | Piece Counting                       |                           | ×                   | ×           | ○           | ○                  | ○                                    | △                 | ○          | ○                             | ○                   |
|                           | Percentage Weighing                  | ×                         |                     | ×           | ○           | ○                  | ○                                    | △                 | ○          | ○                             | ○                   |
|                           | Formulation                          | ×                         | ×                   |             | ○           | ○                  | ○                                    | ×                 | ×          | ×                             | ○                   |
| Comparator                | Target Mode                          | ○                         | ○                   | ○           |             | ×                  | ○                                    | ○                 | ○          | ○                             | ○                   |
|                           | Checkweighing Mode                   | ○                         | ○                   | ○           | ×           |                    | ○                                    | ○                 | ○          | ○                             | ○                   |
| Output Functions          | WindowsDirect Communication Function | ○                         | ○                   | ○           | ○           | ○                  |                                      | ×                 | ○          | ○                             | ○                   |
|                           | Continuous Output                    | △                         | △                   | ×           | ○           | ○                  | ×                                    |                   | ×          | ×                             | *                   |
|                           | Auto Print                           | ○                         | ○                   | ×           | ○           | ○                  | ○                                    | ×                 |            | ×                             | ○                   |
|                           | Output Timing Change Function        | ○                         | ○                   | ×           | ○           | ○                  | ○                                    | ×                 | ×          |                               | ○                   |
|                           | GLP output function                  | ○                         | ○                   | ○           | ○           | ○                  | ○                                    | *                 | ○          | ○                             |                     |

|      |         |         |         |          |          |          |          |          |          |          |
|------|---------|---------|---------|----------|----------|----------|----------|----------|----------|----------|
| See: | Page 87 | Page 92 | Page 96 | Page 102 | Page 104 | Page 111 | Page 108 | Page 106 | Page 129 | Page 142 |
|------|---------|---------|---------|----------|----------|----------|----------|----------|----------|----------|

○ : Can be used in combination

△ : Can be used in combination while the weight value is displayed

×











\* : Weight readings are output, but no other information is output.

## Menu Map

The menu map represents the organization of the menu options graphically to make it easy to understand. It is useful for quickly accessing the menu option you want to use.

For details on the organization of the menu settings and the method of operation of the menu, see "3. MENU SETTINGS" (👉 page 46).

### Reading the Menu Map

| Conventions Used in the Menu Map                                                    | Explanation of Operation                                                                                                                                                                                                                                                                                        |
|-------------------------------------------------------------------------------------|-----------------------------------------------------------------------------------------------------------------------------------------------------------------------------------------------------------------------------------------------------------------------------------------------------------------|
|    | Press  or  to search for the menu option.                                                                                                     |
|    | Press  to proceed to the next menu option.                                                                                                                                                                                     |
|                                                                                     | Press  to confirm.                                                                                                                                                                                                            |
|  | Press  to return to the previous menu option.<br>(Pressing  for around 3 seconds during menu operation returns you to the weighing mode.) |
|  | Refers to a page in the instruction manual.                                                                                                                                                                                                                                                                     |
| *                                                                                   | The default settings (settings when the menu is reset)                                                                                                                                                                                                                                                          |

## Main Menu

Press **MENU** **ENTER** in the weighing mode.

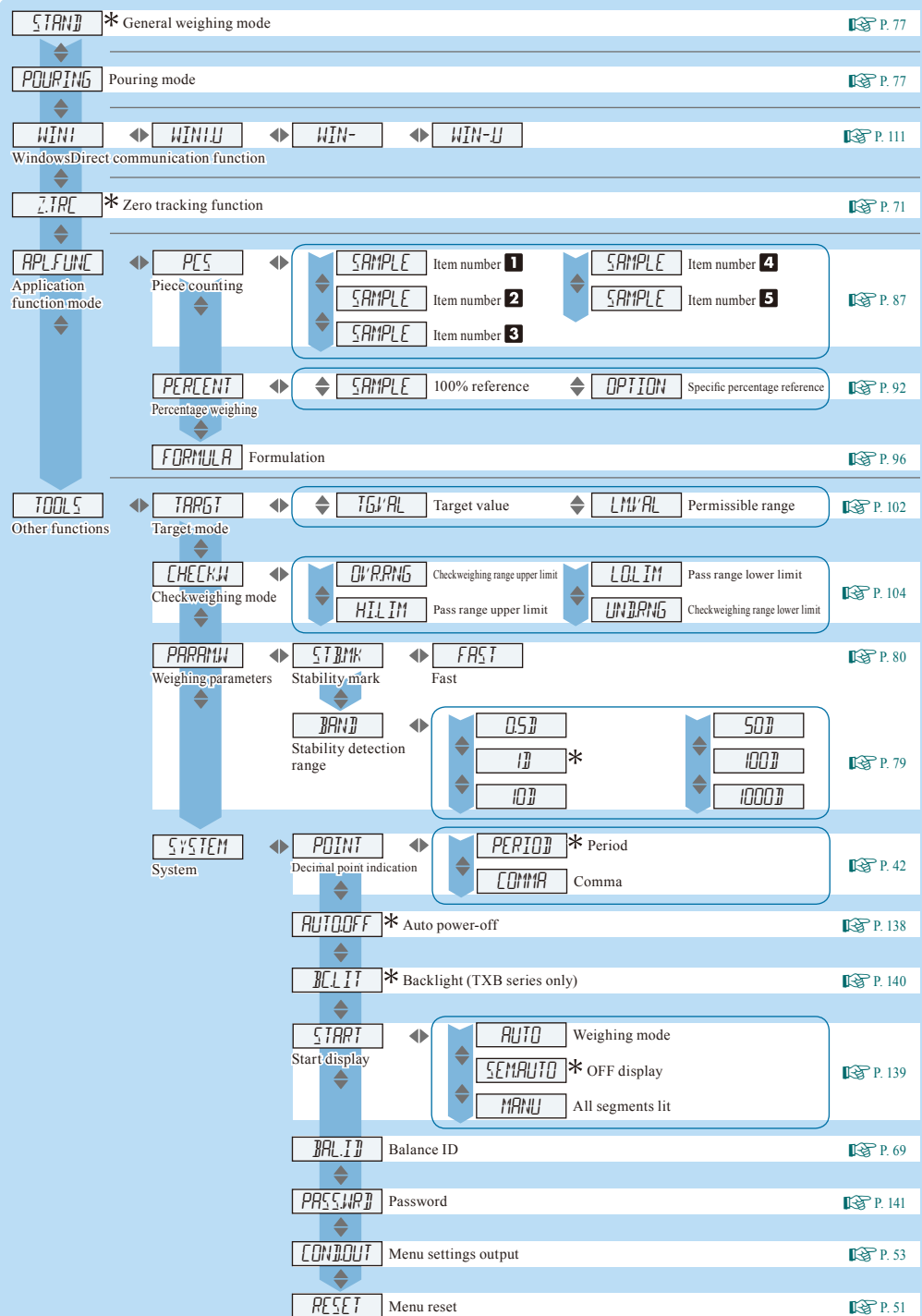

BEFORE WEIGHING

USING THE BALANCE

USING MORE CONVENIENTLY

MAINTENANCE

TROUBLESHOOTING

FOR YOUR INFORMATION

∇ Continued on next page

## ▽ Menu Map



### Data Output Menu

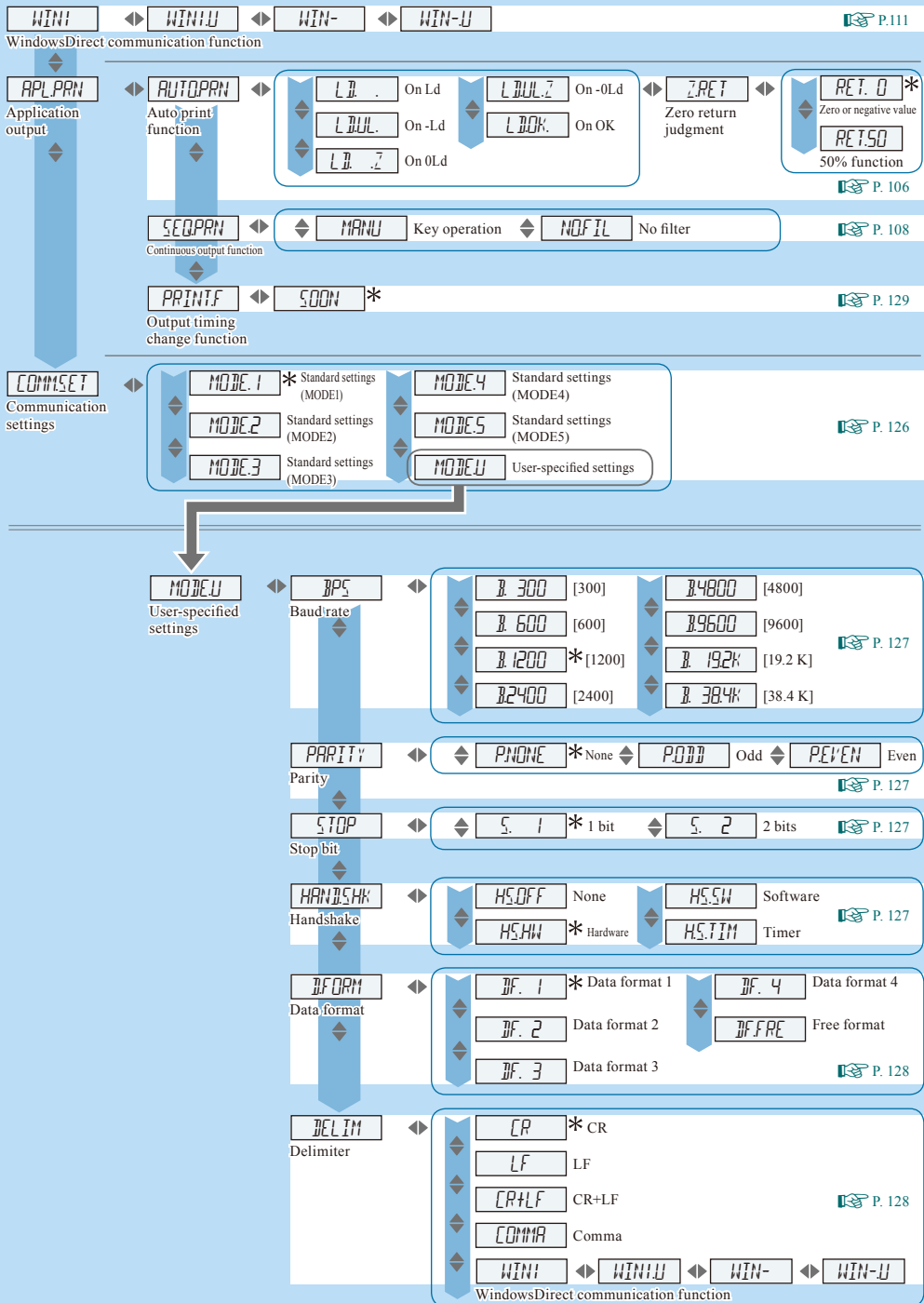

Press **PRINT**  for about 3 seconds in the weighing mode.













## Unit Setting Menu

Press   for about 3 seconds in the weighing mode.



|                      |                                                                                   |                                                                                         |
|----------------------|-----------------------------------------------------------------------------------|-----------------------------------------------------------------------------------------|
| <b>UNIT-g*</b>       | Other units cannot be selected in some countries due to legal restrictions.       |  P. 83 |
| <b>UNIT-mg#1</b>     | #1: mg cannot be selected on models whose minimum indication is 10 mg or greater. |                                                                                         |
| <b>UNIT-kg#2</b>     | #2 kg cannot be selected on the TWC***L and TXC***L.                              |                                                                                         |
| <b>UNIT-ct</b>       |                                                                                   |                                                                                         |
| <b>UNIT-U</b>        | ◀ <b>CON:K</b> Conversion factors                                                 |  P. 84 |
| User-specified units | <b>MIN:D</b> Minimum indication                                                   |  P. 85 |





## Calibration Menu

Press   for about 3 seconds in the weighing mode.

|                |                                                                            |                                                                                            |
|----------------|----------------------------------------------------------------------------|--------------------------------------------------------------------------------------------|
| <b>CAL:E</b>   | ◀ <b>E:CAL</b> Span calibration using an external weight                   |  P. 57  |
| Calibration    | <b>E:TEST</b> Calibration check using an external weight                   |  P. 62  |
|                | <b>I:CAL</b> Span calibration using the internal weight (TW series only)   |  P. 56  |
|                | <b>I:TEST</b> Calibration check using the internal weight (TW series only) |  P. 60  |
| <b>GLP:OUT</b> | GLP output function                                                        |  P. 142 |
| <b>P:CAL</b>   | Calibration of the internal weight (TW series only)                        |  P. 64  |

## Zero / Tare Menu

Press   for about 3 seconds in the weighing mode.

|               |                                                    |                                                                                           |
|---------------|----------------------------------------------------|-------------------------------------------------------------------------------------------|
| <b>Z:TRC*</b> | Zero tracking function                             |  P. 71 |
| <b>A:TARE</b> | Auto tare function                                 |  P. 74 |
| <b>A:ZERO</b> | Auto zero function                                 |  P. 72 |
| <b>T:AREF</b> | ◀ <b>S:OON*</b> Zero / tare timing change function |  P. 75 |



# Index

## Symbol

- OL .....137

## Number

100% reference ..... 92

## Alphabets

### A

---

Adjusting the level. .... 29  
All segments lit .....139  
Application function mode ..... 86  
Auto power-off function .....138  
Auto print function .....106  
Auto print symbol .....23, 108  
Auto tare function .....74  
Auto zero function..... 72

### B

---

Backlight .....140  
Balance ID..... 69  
Battery .....32  
Battery symbol .....23, 33  
Baud rate .....127

### C

---

Calibration check..... 60  
Calibration menu .....46, 153  
Calibration of the internal weight ..... 64  
Calibration record ..... 67  
Carat ..... 82  
Checkweighing mode .....104  
Checkweighing range lower limit value ..104

Checkweighing range upper limit value ..104  
Command ..... 120  
Communication settings .....125  
Communication symbol ..... 23  
Comparator function .....102  
Comparator symbol .....23, 102  
Component number ..... 99  
Container .....38, 39  
Continuous output function.....108  
Conversion factor..... 82

### D

---

Daily inspections.....132  
Data format .....118  
DATA I/O connector .....20, 21  
Data output menu .....46, 152  
DC IN connector .....20, 21  
Decimal point display symbol..... 42  
Default settings .....51  
Delimiter ..... 128  
Display panel .....20, 21, 23

### E

---

Easy setting indicator .....23, 78  
Echo-back .....121  
Entering numerical values..... 49  
ERR .....137  
Error.....137

### F

---

Formulation ..... 96  
Formulation symbol..... 23, 96  
FUNC..... 22

## G

---

|                       |         |
|-----------------------|---------|
| General weighing mode | 77      |
| Glass door            | 130     |
| GLP output function   | 68, 142 |
| Gram                  | 82      |
| Gross weight          | 23      |
| Gross weight symbol   | 23, 97  |
| Ground terminal       | 20, 21  |

## H

---

|                          |     |
|--------------------------|-----|
| Handshake                | 127 |
| Hierarchical menu levels | 46  |
| Hold symbol              | 23  |

## I

---

|                         |        |
|-------------------------|--------|
| Installation site       | 24     |
| Inverse triangle symbol | 23, 50 |
| Item number             | 90     |
| Item number indication  | 23, 90 |

## K

---

|                          |        |
|--------------------------|--------|
| Kensington security slot | 20, 21 |
| Kilogram                 | 82     |

## L

---

|             |    |
|-------------|----|
| Level       | 30 |
| Level screw | 29 |
| LOCKED      | 52 |

## M

---

|                   |          |
|-------------------|----------|
| Main menu         | 46       |
| Maintenance parts | 147, 148 |
| MENU/ENTER        | 22       |
| Menu group        | 46       |

|                                   |        |
|-----------------------------------|--------|
| Menu lock                         | 52     |
| Menu lock symbol                  | 23, 52 |
| Menu map                          | 150    |
| Menu operation keys               | 22     |
| Menu operation key symbol         | 23, 47 |
| Menu reset                        | 51     |
| Miligram                          | 82     |
| Minimum number of displayed digit | 41     |
| Minus symbol                      | 23     |
| Momme                             | 82     |

## N

---

|                                   |        |
|-----------------------------------|--------|
| Net weight                        | 23     |
| Net weight symbol                 | 23, 97 |
| Number of pieces used for setting | 88     |
| Number symbol                     | 23, 49 |
| Numeric value / menu display area | 22     |

## O

---

|                                    |          |
|------------------------------------|----------|
| OFF display                        | 139      |
| OL                                 | 137      |
| Operation keys                     | 22       |
| Optional                           | 147, 148 |
| Output of menu setting information | 53       |
| Output timing                      | 107      |
| Output timing change function      | 129      |
| Outputting the gross weight        | 100      |

## P

---

|                              |     |
|------------------------------|-----|
| P.CAL                        | 64  |
| Parity                       | 127 |
| Pass range lower limit value | 104 |
| Pass range upper limit value | 104 |
| Password                     | 141 |

## P

---

|                                              |        |
|----------------------------------------------|--------|
| Percentage of the reference weight . . . . . | 92     |
| Percentage weighing . . . . .                | 95     |
| Percentage weighing symbol . . . . .         | 23, 95 |
| Periodic inspections . . . . .               | 133    |
| Piece counting mode . . . . .                | 90     |
| Piece counting symbol . . . . .              | 23, 90 |
| Position of the decimal point . . . . .      | 50     |
| Pouring mode . . . . .                       | 77     |
| Pouring symbol . . . . .                     | 23, 77 |
| Printer . . . . .                            | 124    |
| Product label . . . . .                      | 20, 21 |

## R

---

|                             |        |
|-----------------------------|--------|
| Ready symbol . . . . .      | 23, 43 |
| Ready to weigh . . . . .    | 96     |
| Res . . . . .               | 22     |
| Response . . . . .          | 76     |
| RS-232C connector . . . . . | 20, 21 |

## S

---

|                                                  |        |
|--------------------------------------------------|--------|
| Selecting units to display . . . . .             | 83     |
| Sensitivity drift . . . . .                      | 63     |
| Span calibration . . . . .                       | 56     |
| Specific percentage reference . . . . .          | 92     |
| Specific percentage weighing<br>symbol . . . . . | 23, 94 |
| Stability . . . . .                              | 76     |
| Stability detection range . . . . .              | 79     |
| Stability mark . . . . .                         | 23, 79 |
| Stability mark lighting timing . . . . .         | 80     |
| Standby mode . . . . .                           | 43     |
| Startup display . . . . .                        | 139    |
| Stb . . . . .                                    | 22     |

|                           |     |
|---------------------------|-----|
| Stop bit . . . . .        | 127 |
| Switching units . . . . . | 41  |

## T

---

|                           |     |
|---------------------------|-----|
| Target mode . . . . .     | 102 |
| Target value . . . . .    | 103 |
| Taring . . . . .          | 70  |
| Tolerance range . . . . . | 103 |

## U

---

|                                |    |
|--------------------------------|----|
| UNIT . . . . .                 | 22 |
| Unit display area . . . . .    | 22 |
| Unit setting menu . . . . .    | 46 |
| Unit weight . . . . .          | 87 |
| User-specified units . . . . . | 84 |

## W

---

|                                                   |         |
|---------------------------------------------------|---------|
| Warming up . . . . .                              | 33      |
| Weighing capacity . . . . .                       | 145     |
| Weighing mode . . . . .                           | 38      |
| Weight . . . . .                                  | 134     |
| Weight symbol . . . . .                           | 23, 62  |
| WindowsDirect communication<br>function . . . . . | 111     |
| Win symbol . . . . .                              | 23, 112 |

## Z

---

|                                              |        |
|----------------------------------------------|--------|
| Zero / tare menu . . . . .                   | 46     |
| Zero / tare timing change function . . . . . | 75     |
| Zero point . . . . .                         | 70     |
| Zero range . . . . .                         | 72     |
| Zero return judgment . . . . .               | 107    |
| Zero tracking function . . . . .             | 71     |
| Zero tracking symbol . . . . .               | 23, 71 |

MEMO

---

 **SHIMADZU CORPORATION****TOKYO OFFICE**

3, Kanda-Nishikicho 1-chome, Chiyoda-ku, Tokyo 101-8448, Japan  
Phone: 81(3)3219-5641 Fax: 81(3)3219-5710  
Cable Add.:SHIMADZU TOKYO  
Overseas Telex No.: 0232-3291 (SHMDT J)

**KYOTO OFFICE**

1, Nishinokyo-Kuwabaracho, Nakagyo-ku, 604-8511 Japan  
Phone: 81(75)823-1200 Fax: 81(75)812-3438  
Cable Add.:SHIMADZU KYOTO  
Overseas Telex No.: 05422-166 (SHMDS J)

**SHIMADZU INTERNATIONAL TRADING (SHANGHAI) CO., LTD.**

(Shanghai Office)  
Block E, No.570 West Huaihai Road, Shanghai, 200052 P. R. of China  
Phone: 86(21)2201-3888 Fax: 86(21)2201-3666

**SHIMADZU SCIENTIFIC INSTRUMENTS INC**

7102, Riverwood Drive, Columbia, Maryland 21046, USA  
Phone: 1(410)381-1227 Fax: 1(410)381-1222

**SHIMADZU EUROPA GmbH**

Albert-Halm-Strasse 6-10, D-47269 Duisburg, F. R. Germany  
Phone: 49(203)7687-0 Fax: 49(203)7666-25

**SHIMADZU (ASIA PACIFIC) PTE LTD.**

16 Science Park Drive #01-01 The Pasteur Singapore Science Park,  
Singapore 118227, Republic of Singapore  
Phone: 65-778-6280 Fax: 65-779-2935

**SHIMADZU DO BRASIL COMERCIO LTDA.**

Avenida Marques de Sao Vicente, 1771-Barra Funda,  
CEP 01139-003, Sao Paulo, SP, Brazil  
Phone: 55(11)861-1688 Fax: 55(11)861-2209