

UniBloc Analytical Balances

# ATX/ATY Series





### Durable, high-performance aluminum alloy mass sensor UniBloc

The ATX/ATY series incorporates a one-piece aluminum alloy mass sensor technology (UniBloc), first introduced by Shimadzu for precision balances in 1989. It excels in performance, and resists deterioration and damage by ordinary impacts. The UniBloc's compact, uniform structure replaces 70 parts found in a conventional electromagnetic balance sensor assembly and ensures stable temperature characteristics, excellent response time and stable corner-load performance. The UniBloc design permits a consistency of production that assures reliability and a long operational life.



### 3 Benefits of UniBloc.

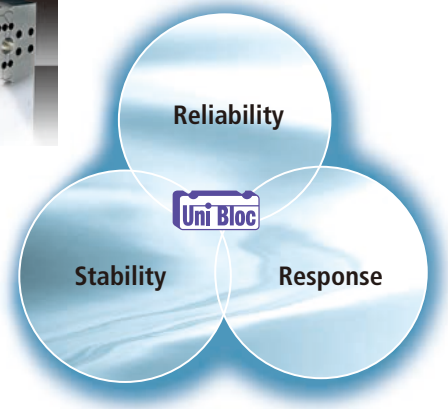

### Touch-key Calibration

Automated calibration can be started by pressing keys. (ATX series)  
Also, your external calibration weights can be used for span calibration.  
(All models)



 Easy Setting Best fit to weighing application 

Quickly adjust the desired ratio of stability and response for every : even during measurement, with one-touch operat

← Responsiveness priority



- When you want to do a quick measurement
- When you want to raise the operation efficiency
- When you want to measure or blend the determination of liquid or powder samples

Indicator



Quickly!  
1.235g

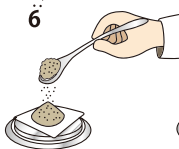

Stability priority →



- When the numerical value is unstable
- When using in the vibration environment
- When the airflow exists constantly and the numerical value fluctuates frequently

Precisely!  
50.000g



Check the overview of AT on our website.

<http://www.shimadzu.com/an/balance/at.html>



Check the easy setting video on YouTube.

[https://www.youtube.com/watch?v=9zVWxjx-J\\_g&list=PLCPY11zjvhZPmTi\\_xW1oGJeSul-YR6qaV&index=1](https://www.youtube.com/watch?v=9zVWxjx-J_g&list=PLCPY11zjvhZPmTi_xW1oGJeSul-YR6qaV&index=1)





### Calibration record

You can leave a record of execution of calibration. With serial number and ID of balance.

### Large pan size

This model has the largest weighing pan in the class (91mm diameter).

### Multiple weighing units

In addition to grams (g), weigh in ct, mg, oz, etc. or a custom conversion units.



### Expanded Piece Counting Function

Unit weights of up to 5 different samples can be easily entered, stored and recalled for use.



### Comparator Function

Compare samples to target values or pass/fail criteria and clearly indicate the results.



### Formulation Mode

Convenient for making many measurements of minute samples and seeking the total mass.

### % measurement

The weight of the sample is converted to a percentage of the reference weight.

### Power saving function

When weighing operation ends. Power automatically turns off after a fixed or pre-set time.



### WindowsDirect Communication Function

Send balance data to Excel or other Windows applications without any data communication software installation required. By combining standard AutoPrint functions with typical spreadsheet functions, even difficult applications can be easily automated.

\*RS232C interface is needed.

### Password lock

In order to ensure that the menu settings are not changed by mistake, the person managing the Balance controls the password and can prohibit menu operation.

Weighing results and analysis results can be stored in a database. Reports can be generated according to results in a prescribed format.

### Analytical Balance AT series



Weighing results by Balance

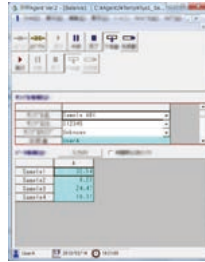

Analysis results by LC

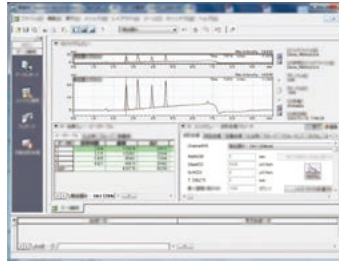

### UHPLC Nexera X2



LabSolutions software can store analysis results and weighing results in a database at the same time.

\* The optional software (LabSolutions Balance) is required in order to connect with LabSolutions.

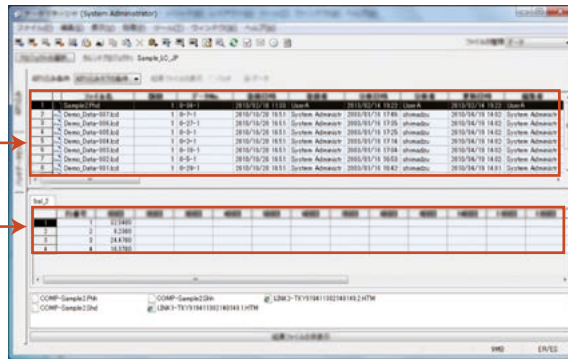

Analysis results by LC

Weighing results by Balance

### Report example

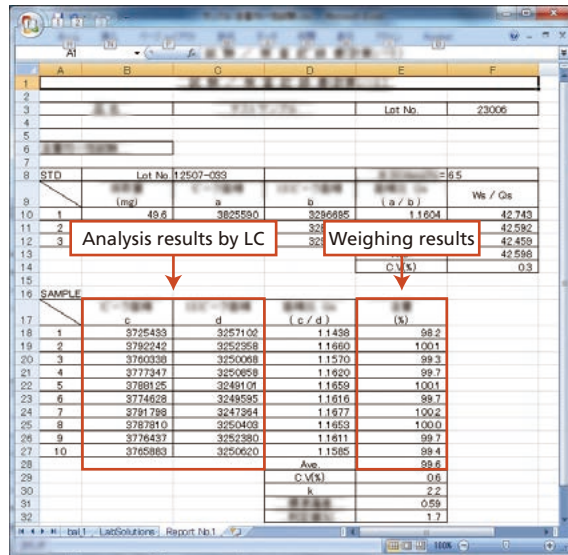

The report can be generated automatically according to results.

## Dimensions

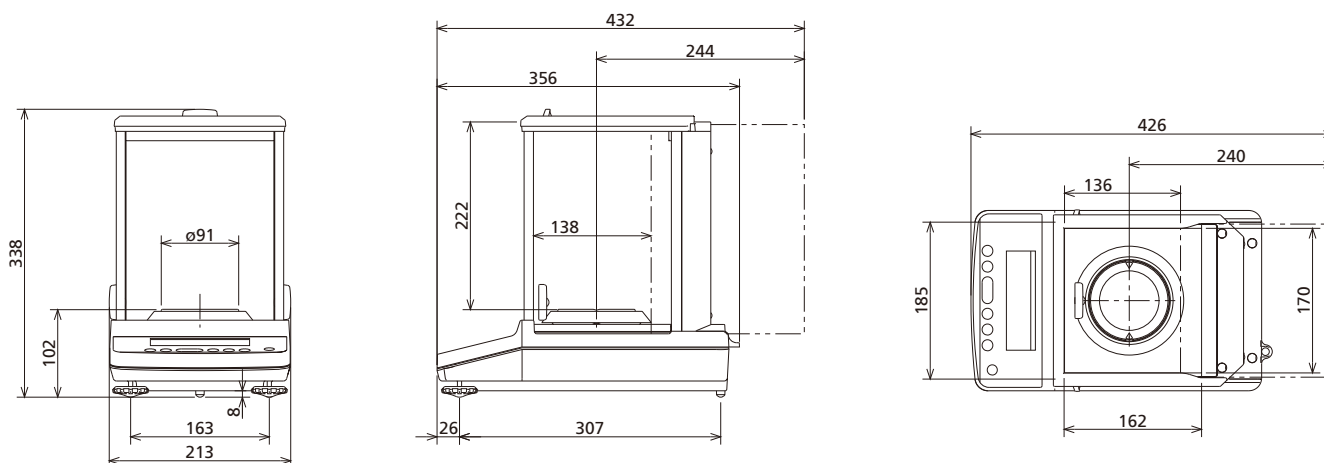

## Specifications

ATX/ATY series

Model	ATX84	ATX124	ATX224	ATX324	ATY64	ATY124	ATY224	ATY324
Capacity	82g	120g	220g	320g	62g	120g	220g	320g
Minimum Display	0.1mg							
Repeatability (Standard Deviation)	≤0.1mg							
Linearity	± 0.2mg							
Stabilisation Time*1	Approx. 3.0 seconds							
Operating Temperature and Humidity Limits	5-40°C 20-85%*2							
Temperature Coefficient for Sensitivity (10-30°C)	± 2 ppm/°C							
Pan Size (mm) approx.	ø91							
Main Body Dimensions (mm) approx.	213(W) × 356(D) × 338(H)							
Main Body Weight (kg) approx.	6.2			6.0				
Power Requirement	12V, 1A							
Internal Calibration	●			—				

\*1 The Stabilisation time is a representative value

\*2 No condensation

## Options

Description
EP-100 Printer
EP-110 Printer
I/O-RS cable
Protection Cover
STABLO-AP Ionizer
USB conversion kit



**For Research Use Only. Not for use in diagnostic procedures.**

This publication may contain references to products that are not available in your country. Please contact us to check the availability of these products in your country.

Company names, products/service names and logos used in this publication are trademarks and trade names of Shimadzu Corporation, its subsidiaries or its affiliates, whether or not they are used with trademark symbol "TM" or "®".

Third-party trademarks and trade names may be used in this publication to refer to either the entities or their products/services, whether or not they are used with trademark symbol "TM" or "®".

Shimadzu disclaims any proprietary interest in trademarks and trade names other than its own.

The contents of this publication are provided to you "as is" without warranty of any kind, and are subject to change without notice. Shimadzu does not assume any responsibility or liability for any damage, whether direct or indirect, relating to the use of this publication.

Shimadzu Corporation

[www.shimadzu.com/an/](http://www.shimadzu.com/an/)